

APOLLO
MAINTENANCE MANUAL

 1300 888 479

 sales@dieciaustralia.com.au

 1/5 Melito Court, Prestons NSW

 www.dieciaustralia.com.au

1 Info



www.dieci.com

Dieci s.r.l.

VIA E. MAJORANA, 2-4
42027 - MONTECCHIO E. (RE) - ITALY
TEL. ++39 0522-869611
FAX ++39 0522-869744
e-mail: info@dieci.com

Fully paid-up share capital € 10.000.000,00

Companies Register C.R. No. 01283560686 - Economic and Administrative Index C.R. No. 204278

Tax Code 01283560686 - VAT no. 01682740350

Each vehicle is provided with:

- Copy of this manual
- A copy of the use and maintenance manual of the engine prepared by the manufacturer
- A copy of the use and maintenance manual for each device or equipment which is installed on this vehicle.

These manuals have been prepared by the respective suppliers and are faithfully reproduced in full by **DIECI S.R.L.** Behind their specific authorization: they can be enriched with additional specifications drawn up by **DIECI S.R.L.**



WARNING

All documentation provided is an integral and essential part of the product and must be kept at the disposal of the users; they must carefully read what is written in the above mentioned documentation before using it.



DANGER

Improper, incorrect or unreasonable use of the vehicle or accessory installed on it is not allowed as also any intervention that alters its structure or function is not allowed.



NOTICE

Reproduction of all or part of the contents of this manual and any multimedia attachment.

Dieci s.r.l. will protect the ownership rights of these materials.



CAUTION

A copy of this manual must always be available to the operator on the vehicle.

USE AND MAINTENANCE MANUAL	
Code:	AXH1230
Version:	1 -
Original instructions language:	Italian
Translation language of the original instructions:	English
Translation of the original instructions for:	- Apollo 25.6

1.1 General

The purpose of this publication is to provide safe and effective instructions to the Operator on use and maintenance of:

- Apollo 25.6

This vehicle has been designed and built as a self-propelled vehicle with operator's seat, wheels, designed for use on paved or natural ground and on uneven ground.

It consists of a main support structure suitable to support the extensible boom.

The head of the boom can be fitted with forks or other equipment only if approved by **Dieci s.r.l.** or only if the manufacturer of the equipment declares that its use conforms with the type of machine.

When used normally, the machine performs loads lifting and positioning by extending/ retracting, lifting/ lowering the boom.



WARNING

Any other use is considered contrary to the intended use by DIECI s.r.l. which, therefore, can not be responsible for damage to objects and the machine itself, or injury to persons that might derive from misuse.

For other controls, or complaints to agencies, refer to the applicable local legislation in the country of use of the vehicle.

1.2 Identification of the machine

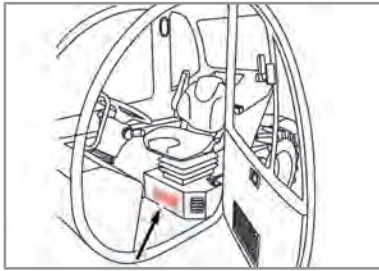

150640-1

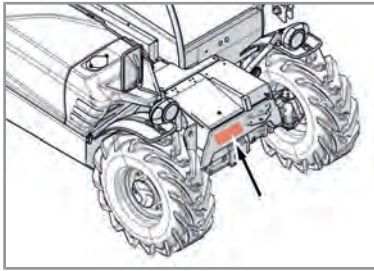

150640-2

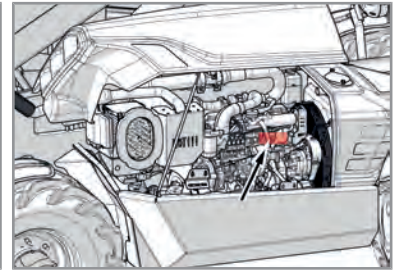

150640-3

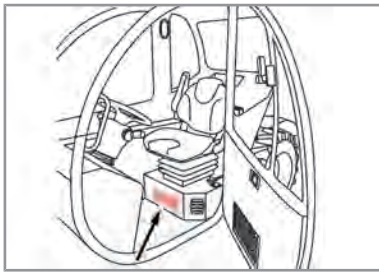

150640-4

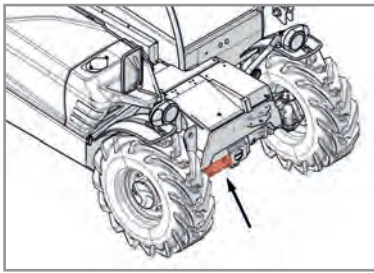

150640-5

Vehicle model (fig. 150640-1)
Year
Serial number of the chassis (fig. 150640-2)
Serial number of the engine (fig. 150640-3)
Serial number of the cab (fig. 150640-4)
Serial number of the transmission (fig. 150640-5)
Owner / Operator
Address of the Dealer or Agent
Delivery date
Warranty expiry date

Equipment code	Serial number	Year
.....

Equipment code	Serial number	Year
.....
.....
.....

2 Letter

Dear Customer,

congratulations and thank you for choosing **DIECI**.

This Use and Maintenance Manual has been written to help you fully appreciate your vehicle.

We strongly recommend that you read this manual in its entirety before using the vehicle.

It contains information, advice and important warnings that will help you to fully take advantage of the technical capabilities of your **DIECI** vehicle.

You will learn about its features and special practical information in addition to information about its maintenance, driver and operation safety to help maintain your **DIECI** vehicle over time.

We are confident that you will be happy with your new vehicle and we remain at your disposal should you have any further queries.

Sincerely,

Sales Management

Contents

- 1 Info 2**
 - 1.1 General 4
 - 1.2 Identification of the machine 5
- 2 Letter 7**
- 3 Introduction 15**
 - 3.1 Manual structure 15
 - 3.2 Purpose and content 15
 - 3.3 Preservation 15
 - 3.4 Recipients 15
 - 3.4.1 Training 15
 - 3.4.2 Training 16
 - 3.4.3 Qualification 16
 - 3.5 Terms, units of measurement and abbreviations used 17
 - 3.6 Symbols used 19
 - 3.6.1 Symbols key in manual 19
 - 3.7 Machine general warnings 19
 - 3.8 Equipment general warnings 20
 - 3.9 Intended use 21
 - 3.10 Contraindications for use 21
 - 3.11 Declaration of first test 21
 - 3.12 Liability 21
 - 3.13 Manufacturer 22
 - 3.14 Certification and CE marking 23
- 4 Warranty 24**
 - 4.1 Exclusions from the guarantee 24
 - 4.2 Warranty: duration 24
 - 4.3 Warranty: commencement 24
 - 4.4 Warranty: activation 24
 - 4.5 Warranty: validity 25
 - 4.5.1 Guarantee in countries with assistance centers 25
 - 4.5.2 Guarantee in countries with NO assistance centers 25
 - 4.5.3 Examining replaced faulty parts 25
 - 4.5.4 Additional guarantee for repairs and replacement parts 25
 - 4.5.5 Intervention campaigns for faulty products 25
 - 4.6 Warranty: intervention request 25
 - 4.6.1 Guarantee: claim 25
 - 4.6.2 Obligation of vehicle downtime 26
 - 4.7 Non-activation, failure to grant, termination 26
 - 4.7.1 Warranty: failure to grant 26
 - 4.7.2 Guarantee: termination 26
 - 4.8 Final terms 26
- 5 Safety regulations 27**
 - 5.1 General warnings 27
 - 5.2 Safety indications 29

5.3	Personal protective equipment.....	29
5.3.1	Protective clothing.....	29
5.3.2	Protect yourself against noise.....	30
5.3.3	Protections against objects falling from height.....	30
5.3.4	Protect yourself from flying fragments.....	30
5.4	Preparing for accidents.....	31
5.4.1	First Aider Tasks.....	31
5.4.2	Emergency call.....	31
5.4.3	Traumas.....	32
5.4.4	Hemorrhages.....	32
5.5	Preventing fires and accidents.....	32
5.5.1	Risks of fires.....	32
5.5.2	Risks of inhaling gas.....	33
5.5.3	Risks of batteries exploding.....	34
5.5.4	Residual risks.....	34
5.5.5	Contact with dangerous substances.....	35
5.6	Storing dangerous liquids.....	36
5.7	Warnings for safe working.....	37
5.7.1	Ensuring the vehicle is clean.....	37
5.7.2	Checking for damage.....	37
5.7.3	Start working with the vehicle.....	37
5.7.4	Passengers transportation.....	38
5.7.5	Electrical system protection.....	38
5.7.6	Signals to multiple vehicles.....	38
5.7.7	Working with the danger of falling masses and objects.....	40
5.7.8	Working near electrical lines.....	41
5.7.9	Working under the snow.....	42
5.7.10	Working with scarce lighting.....	42
5.7.11	Working in closed areas or dangerous atmospheres.....	42
5.7.12	Reduce vibrations.....	43
5.8	Working in windy conditions.....	44
5.9	Assessing the consistency of the work ground.....	45
5.10	Moving safely.....	45
5.11	General warnings for moving the load.....	46
5.12	Use of cables, ropes and slings.....	48
5.13	Road travel.....	49
5.13.1	Road travel warnings.....	49
5.13.2	Road travel instructions.....	49
5.14	Momentary stop.....	50
5.15	Parking the vehicle.....	50
5.16	Starting and stopping the machine.....	52
5.16.1	General warnings regarding starting up the vehicle.....	52
5.16.2	Inspections prior to starting-up.....	52
5.16.3	Starting-up the engine.....	53
5.16.4	Warm-up after starting-up.....	54
5.16.5	Start-up at low environmental temperatures.....	54
5.16.6	Causes of failed start-ups.....	55
5.16.7	Turn off the vehicle.....	55
6	Safety devices.....	56
6.1	Safety stickers.....	56
6.1.1	Warnings for safety stickers.....	56
6.1.2	Meaning of safety stickers.....	56
6.1.3	Safety stickers position on the vehicle.....	60

6.1.4	Safety stickers position in the cab.....	61
6.2	Reference to safety devices.....	61
7	Vehicle description	62
7.1	Left side description	63
7.2	Right side description.....	64
7.3	Engine description.....	65
7.4	Cab description.....	66
8	Components description	67
8.1	Cab.....	67
8.1.1	ROPS - FOPS Cab.....	67
8.1.2	Door opening	68
8.1.3	Climbing in/out	68
8.1.4	Door glass.....	69
8.1.5	Rear glass	70
8.1.6	Sunshade	70
8.1.7	Cab ventilation.....	70
8.1.8	Air conditioning *	72
8.1.9	Cab lighting	73
8.1.10	12V Socket.....	73
8.1.11	Steering wheel	74
8.1.12	Multifunction lever	74
8.1.13	Lights turning on	77
8.1.14	Seat.....	80
8.1.15	Emergency Lights	84
8.1.16	Emergency stop	85
8.1.17	Spirit Level.....	85
8.1.18	Emergency exit: Rear glass	86
8.1.19	Cab front glass protection *	86
8.1.20	Warnings in case of vehicle tipping.....	86
8.2	Parking brake.....	87
8.2.1	Braking circuit errors list	88
8.2.2	Deactivating the parking brake manually.....	89
8.3	Matrix EVO instrument panel.....	90
8.3.1	Components	90
8.3.2	Initial check.....	91
8.3.3	Home	92
8.3.4	Central instrument panel: Menu.....	93
8.3.5	General alarm icon.....	93
8.3.6	Active errors	94
8.3.7	Service	95
8.3.8	Clock and clock setting.....	95
8.3.9	Hour meter	96
8.3.10	Check page.....	96
8.3.11	Info page.....	96
8.3.12	Anti-tipping device	97
8.4	Transmission.....	106
8.4.1	Movement selection lever	106
8.4.2	Service braking pedal.....	107
8.4.3	Inching Pedal	108
8.4.4	Accelerator pedal	109
8.4.5	Transmission manual disable.....	109
8.5	Mechanical steering selector	110
8.6	Wheels alignment check *	111

8.7	Joystick.....	113
8.7.1	Joystick with mechanical deadman button	113
8.7.2	Joystick for man basket prearrangement.....	117
8.7.3	Joystick error list.....	118
8.8	Continuous oil function *	121
8.8.1	Continuous oil function on Joystick with mechanical deadman.....	121
8.8.2	Continuous oil function for vehicles with man basket function	122
8.9	Rear hydraulic sockets *	123
8.10	Hydraulic sockets and electrical contact on boom head *	124
8.11	Electrical contact on boom head *	125
8.12	Trailer descent *	126
8.13	Quick coupling.....	127
8.14	Electronic hand throttle	128
8.15	Safety rod.....	128
8.16	Wheel wedge.....	129
8.17	Block valves	129
8.18	Diagrams notebook.....	130
8.18.1	Capacity diagrams	130
8.19	Water heater *	136
8.20	Fan reversal *	137
8.21	Boom suspension *	137
8.22	Kubota engine Stage IIIA - Tier 3.....	139
9	Equipment	140
9.1	General warnings on equipment use.....	140
9.1.1	Equipment pre-use checks.....	142
9.2	Equipment installation procedure.....	144
9.2.1	Dieci Plate.....	144
9.2.2	"ISO" type plate	146
9.3	Hydraulic connections	149
9.3.1	Warnings for hydraulic connections	149
9.3.2	Type of hydraulic quick couplings.....	150
9.3.3	References for correct connection.....	150
9.3.4	Push-Pull couplings connection.....	151
9.3.5	Flat-Face couplings connection.....	153
9.3.6	Closed center distributor: Relieve the pressure through the trailer Descent button	154
9.4	Electrical Connections.....	155
9.4.1	Warnings for electrical connections.....	155
9.4.2	Procedure for connecting electrical connections.....	155
9.5	Equipment removal	157
9.5.1	Electrical connections removal.....	157
9.5.2	Push-Pull couplings removal.....	158
9.5.3	Flat-Face couplings removal	160
9.6	Forks.....	160
9.6.1	Identification	160
9.6.2	Description	161
9.6.3	Forks check.....	162
9.6.4	Forks use	163
9.6.5	Forks adjustment.....	163
9.6.6	Fork extensions.....	164
9.6.7	Forks safe working procedures.....	165

9.7	Fork shifter	171
9.7.1	Fork shifter installation	171
9.7.2	Fork shifter description	171
9.7.3	Fork shifter installation	172
9.7.4	Fork shifter maintenance	172
9.7.5	Fork shifter use	173
9.7.6	Fork shifter hydraulic diagram	174
9.8	Bucket	175
9.8.1	Buckets identification	175
9.8.2	Buckets description	175
9.8.3	Buckets safety stickers	175
9.8.4	Bucket use	176
9.8.5	Tilting indicator use	177
9.8.6	Buckets Safe Working Procedures	177
9.9	Equipment lifting	179
9.10	Equipment transport	179
10	Emergency procedure	180
10.1	Vehicle towing	180
10.1.1	Towing the machine with engine in failure	181
10.2	Man basket recovery in case of failure	182
11	Maintenance	184
11.1	Maintenance warnings	184
11.1.1	Avoid accidents during maintenance	185
11.2	Engine hood opening	188
11.3	Engine lower protection plate removal	189
11.4	Battery	190
11.4.1	Low maintenance batteries	191
11.4.2	"Zero" maintenance batteries	191
11.4.3	Battery: Instructions for recharging	191
11.4.4	Battery cut-off switch	192
11.4.5	Battery: Replacement	192
11.4.6	Start up with auxiliary batteries	193
11.5	Fuel	194
11.5.1	Specifications for recommended fuel	194
11.5.2	Cleaning and storing fuel	194
11.5.3	Refueling	195
11.5.4	Fuel tank: Cleaning	195
11.5.5	Fuel filters: Replacement	196
11.6	Safety stickers: Inspection	196
11.7	Lubrication	196
11.8	Preliminary maintenance operations	197
11.8.1	Prepare the vehicle for maintenance	197
11.9	Engine maintenance	198
11.9.1	Belts: Check and adjustment	198
11.9.2	Engine oil: Check and filling up	198
11.10	Air filter: Cartridges cleaning and replacement	198
11.11	Radiator maintenance	201
11.11.1	Air recirculation grids and nets	201
11.11.2	Radiator: Checking and cleaning	201
11.11.3	Radiator: Liquid filling up and replacement	201
11.12	Hydraulic system maintenance	203

11.12.1 Hydraulic oil: Check and replacement	203
11.12.2 Internal hydraulic oil intake filter: Replacement	204
11.12.3 External hydraulic oil intake filter: Replacement	205
11.13 Brakes maintenance	205
11.13.1 Brake: Inspection	205
11.13.2 Brake: Coolant level check	206
11.14 Wheel maintenance	206
11.14.1 Epicycloidal reduction gear oil: Check and replacement	206
11.14.2 Wheel nuts tightening	207
11.14.3 Tires	208
11.15 Lighting	210
11.15.1 Headlight	211
11.15.2 Tail light	212
11.15.3 Work light *	212
11.15.4 Led work light*	213
11.16 Window washer fluid tank	213
11.17 Ventilation system maintenance	214
11.17.1 Cab ventilation filter: Cleaning and replacement	214
11.17.2 Air conditioning: Cleaning *	214
11.18 Cylinder lock valves maintenance	215
11.19 Differential Axles Maintenance	218
11.19.1 Differential axles oil: Check and replacement	218
11.20 Hydraulic fittings tightening torques	219
11.21 Bolts tightening torques	220
11.21.1 Bolts tightening torques: Fine pitch	220
11.21.2 Bolts tightening torques: Coarse pitch	222
12 Technical assistance service	224
12.1 Spare parts supply	224
12.2 Assistance to owner / operator	224
12.3 Technical Assistance Service address	224
13 Problems diagnostics	225
13.1 Engine	225
13.2 Hydraulic transmission system	225
13.3 Brakes	226
13.4 Steering wheel	226
13.5 Telescopic boom	226
14 Cleaning	228
14.1 Machine cleaning	228
14.2 Glasses cleaning	228
14.3 Cleaning the cab	228
14.4 Safety stickers cleaning	229
15 Lifting the vehicle	230
16 Transporting the vehicle on a trailer	231
17 Storing the vehicle	232
17.1 Long period of inactivity	232
17.2 Long period of inactivity	232

17.3 Restarting the vehicle	232
18 WASTE DISPOSAL	234
18.1 Ecological considerations.....	234
18.2 Protect the environment.....	234
19 Demolition	235
20 Wiring diagram	236
20.1 Components legend	236
20.2 Wiring diagram sheets	241
20.3 Fuse box.....	252
20.4 Engine compartment fuses.....	253
21 Hydraulic diagram.....	254
21.1 Components legend	254
21.2 Hydraulic diagram.....	255
22 Technical data	256
22.1 Apollo 25.6.....	256
22.1.1 Equipment.....	262
22.2 Environmental conditions.....	264
22.3 Electromagnetic Interference	264
22.4 Radiations	264
22.5 Standard hydraulic oil.....	264
22.6 Hydraulic oil for cold climates	265
22.7 Fork technical data	266
22.8 Fork shifter technical data.....	267
22.9 Buckets technical data.....	268
22.10 Tires data.....	269
23 Control and maintenance logs	270
23.1 Type of logs.....	270
23.1.1 Control log.....	270
23.1.2 Maintenance Log.....	270
23.2 Instructions for compiling the logs	270
23.2.1 Warnings on the control log	270
23.2.2 Warnings on the maintenance log	271
23.2.3 Logs compiling	271
23.2.4 Logs legend	271
23.3 Periodic checks and recording mode (Italian only).....	272
23.4 Obligation and how to report to I.N.A.I.L. (National institute for insurance against accidents at work) (Italy only) ...	272
23.5 Control log.....	273
23.6 Maintenance log.....	282

3 Introduction

3.1 Manual structure

This manual is an integral part of the official documentation of the vehicle and of the equipment. It must be carefully stored and be available to the managers, the users and personnel in charge of maintenance.

3.2 Purpose and content

This manual is an integral part of the official documentation and is aimed at supplying the Operator with all the information required concerning technical aspects, operation and safety during the entire lifespan of the vehicle or equipment.



CAUTION

This manual should be read carefully before the first use or before maintenance.



NOTICE

If in doubt on the correct understanding of the instructions, contact the Manufacturer for clarifications.

3.3 Preservation

The instruction manual must be kept near the equipment available to the Users (in the cab or on the equipment where set up) inside a dedicated envelope, protected from liquids and anything that might make it illegible.

If the manual becomes creased and/or be, even partially, damaged or illegible or in case of loss of the manual, it must be replaced immediately by contacting the **Dieci Technical Assistance Service**, giving the details of the manual found on the first page of the manual.

3.4 Recipients

This manual is addressed to the following persons:

- **Operator:** instructed person, trained with specific theoretical-practical course concerning use of the vehicle or equipment
- **Generic maintenance technician:** trained and educated person to perform routine maintenance interventions with basic mechanical, electrical and hydraulic knowledge
- **Specialized maintenance technician:** trained and educated person to perform routine and extraordinary maintenance interventions with in-depth and specific mechanical, electrical and hydraulic knowledge, normally sent or authorized by **DIECI s.r.l.** or the dealer.



CAUTION

The users must not carry out operations reserved for maintenance technicians or qualified technicians. The Manufacturer is not liable for damage deriving from the non-compliance with this prohibition.

3.4.1 Training

This manual gives the users all technical data on the vehicle or on the equipment, the presence and type of control and safety devices and the presence and meaning of the safety stickers and plates.

All vehicle or equipment users must have all necessary information, training and education in relation to the correct use conditions of the means and foreseeable anomalous risks.

The information, training and educating must be implemented upon introduction of new work equipment and for each work equipment available to users.



NOTICE

Ensure to respect the current laws and Standards in the selling country of the machine with regard to information, training and educating of personnel to use the vehicle and its equipment.

The employer is obliged to inform personnel on the following topics related to safety during use:

- Risk of injury
- Individual safety devices and machine safety devices, set up for operator safety
- General accident-prevention rules and/or foreseen by international directives
- Accident-prevention rules of Legislation of the Country where the vehicle is intended for use

The operator, before starting the work, must know the characteristics of the machine and must have fully read this Use and Maintenance Manual.

3.4.2 Training



CAUTION

The operator in charge of using the vehicle or equipment must have attended a suitable theoretical-practical course lasting as long as indicated by legal prescriptions in the Country where the vehicle or equipment is used.

Training must at least include the following subjects:

- Use and limits of the functioning and emergency controls of the equipment and of the vehicle on which the equipment is mounted
- Knowledge and awareness of the Use and Maintenance Manual and of the control marks, of the instructions and of the warnings applied on the vehicle
- Knowledge and understanding of the Standard on this equipment, including the educating aimed at recognizing and avoiding potential dangers at work
- Knowledge of the mechanical functioning of the vehicle sufficient for recognizing a real or potential failure
- Hints on constructive particulars of the vehicles and on static and dynamic stability concepts
- Correct use of the vehicle procedures in safe conditions with regard to the work place and the load to be handled/lifted, capacity and guide notions
- Knowledge and use of the PPE to be worn during use of the vehicle and of the equipment.
- Knowledge and execution of the routine maintenance to be carried out

Training must be carried out under the supervision of a qualified person in an open area and free from obstacles. At the end of this practice, the trainee must be able to safely use the equipment, and the vehicle on which it is installed.

The operator must also be trained on the responsibility and authority of not using the vehicle in case of failure or presence of unsafe conditions, and request further information from the Manufacturer or authorized dealer.

3.4.3 Qualification

The vehicle and equipment are intended for professional use; their use must therefore be entrusted to qualified figures, in particular:

- Being of adult age
- Be physically and psychically suitable to carry out particularly difficult technical work

- Have been adequately trained on the use and maintenance of the vehicle and equipment
- Have been judged suitable by the employer to carry out the work entrusted to them
- Are able to understand and interpret the manual and the safety requirements
- Know the emergency procedures and their activation
- Have the ability of activating the specific type of vehicle or equipment
- Are familiar with the specific standards of the case
- Have understood the operational procedures defined by the Manufacturer of the vehicle or equipment

3.5 Terms, units of measurement and abbreviations used

DECIMAL METRIC SYSTEM (IS)		ENGLISH IMPERIAL SYSTEM (IMP)	
NAME	SYMBOL	NAME	SYMBOL
SURFACE			
square meter	m ²	square foot	ft ²
ELECTRICITY			
Ampere	A		
Volt	V		
FORCE			
kiloNewton	kN		
Newton	N		
FORCE FOR LENGTH - TORQUE			
Newton-meters	N·m	pounds-inch	lb·in
SURFACE FORCE - PRESSURE			
kilopascal	kPa	pound/square inch	psi
ROTATION FREQUENCY			
Revolutions per minute	rpm		
LENGTH			
kilometer	km	mile	mi
meter	m	foot	ft
centimeter	cm	inch	in
millimeter	mm	inch	in
MASS			
kilogram	kg	pound	lb
ton	t	pound	lb
POWER			
kilowatt	kW	horse power	HP
Watt	W		
TEMPERATURE			
Celsius degrees	°C	Fahrenheit degrees	°F
SPEED			
kilometers per hour	km/h	miles per hour	mph
meters/second	m/s	feet/second	ft/s
VOLUME			
cubic meter	m ³	cubic yard	yd ³
		cubic inch	in ³

liter	l	UK gallon	UK gal
TIME			
hour	h	hour	h
minute	min	minute	min
second	s	second	s
VOLUME PER TIME			
cubic meter per minute	m ³ /min	cubic foot per minute	ft ³ /min
liter per minute	l/min	UK gallon per minute	UK gal ³ /min
SOUND POWER AND ACOUSTIC PRESSURE			
decibel	dB		







3.6 Symbols used

3.6.1 Symbols key in manual

Carefully read the safety regulations given and follow all recommended precautions in order to avoid potential risks and safeguard your health and safety.

The symbols listed below are inserted to highlight situations which **DIECI S.R.L.** considers particularly important.

If in doubt, contact your agent or dealer.

SYMBOL	MEANING	COMMENT
	RISKS	Indicates an important safety message. When you see this symbol, carefully read the information that follows and inform other operators in order to prevent risks and hazards.
	SPECIFIC DANGER	Indicates a specific danger with risk, even serious, for the user. (Electrical danger provided as example)
	ATTENTION	Indicates a warning addressed to avoid a potentially dangerous situation
	NOTE	Indicates a note to key functions, useful information or references to other paragraphs or manuals.
	MAINTENANCE	Indicates a maintenance operation that must be carried out by a General or specialized maintenance technician.
	OPTIONAL	Indicates possible installation or presence of an optional available at Dieci s.r.l. distributors.

3.7 Machine general warnings

Every machine or equipment comes with a copy of its own manual.



CAUTION

Reproduction of all or part of the contents of this manual or of the multimedia attachment, if any, is prohibited.

Dieci s.r.l. will protect the ownership rights of these materials.



CAUTION

It is compulsory to read and understand this manual before using the machine or various equipment and to carefully follow the indications therein. The instructions for use, maintenance and repair described in this handbook must be followed if the vehicle is to be considered as being operated in accordance with the manufacturer's intended uses.



NOTICE

DIECI s.r.l. reserves the right to carry out possible modifications to the vehicle or accessories for technical or commercial reasons without prior notice.

- A copy of the use and maintenance manual relative to machine parts or equipment of the respective suppliers can be supplied. These manuals are written by the respective product suppliers and reproduced accurately and in full by **DIECI s.r.l.** with their specific authorization: they can be enhanced with further specifications drawn up by **DIECI s.r.l.**
- This Use and Maintenance manual is also provided by the Dealer upon delivery of the vehicle, in order to make sure that these instructions are read and correctly understood. Should you have trouble understanding any part of this manual, do not hesitate to contact your nearest Dealer for clarification.
- All documentation provided constitutes an integral and important part of the product and must always be available to users.
- The instructions for use, maintenance and repair described in this handbook must be followed if the vehicle is to be considered as being operated in accordance with the manufacturer's intended uses.
- This manual assumes that the health and safety standards in the work place, in force in the place of use of the vehicle and of the equipment, are complied with.
- This Use and Maintenance Manual in the user's language, must be carefully stored on the vehicle at all times in an accessible and well known place to all users. If the manual becomes creased and/or be, even partially, damaged or illegible or in case of loss of the manual, it must be replaced immediately by contacting the Dieci Technical Assistance Service, giving the details of the manual found in the "Introduction" chapter.
- Improper, incorrect, or irrational use of the vehicle or the accessories with which it is equipped as well as modification to its physical structure or functioning is prohibited. A different use is strictly prohibited and relieves **DIECI s.r.l.** from responsibility for damage caused to persons, things or animals.
- **DIECI s.r.l.** is not liable for damage caused by negligent use of this vehicle or the accessory even if said damage is not a result of intentional improper use. Everything possible has been done during the design and construction phases of vehicles and accessories to make your job as safe as possible. Due caution, however, is indispensable and there is no better rule to prevent accidents.
- To correctly use the components and machine controls recalled in the following pages, refer to the specific use and maintenance manual of the machine.
- If the vehicle or the equipment must be used in particularly severe conditions (for example: In dusty environments or worksites, on argillaceous or muddy terrain), we advise consulting your nearest dealer for specific instructions. Failure to observe these instructions may result in the vehicle's guarantee being voided.



WARNING

For your safety and the safety of others, do not change the structure or adjustment of the various components of the machine or equipment.



NOTICE

The right and left positions indicated in this manual refer to the view of the operator sitting in the driver's seat (looking forwards).

3.8 Equipment general warnings



WARNING

Only equipment CE certified by the relative manufacturer can be used on DIECI machines, as well as equipment approved or falling within the technical limits set out by DIECI S.r.l.

Before commissioning any kind of accessory make sure about its compatibility with the operating machine and about the calibration of the safety system related to the accessory used.

The interchangeable equipment manufacturer must guarantee that the combination of such equipment and the basic machine on which the equipment is intended for, meets all the basic health and safety requirements, providing an adequate evaluation procedure of compliance.

DIECI S.r.l. liability shall not be involved if equipment use or modifications do not comply with the above mentioned requirements.

3.9 Intended use

The machine described in this document must be used only for the purposes set out in this Use and Maintenance manual.

Adherence to and strict compliance with the terms of use, repair and maintenance, as specified by the Manufacturer, are essential elements covered by the intended use.



WARNING

The machine must be used **ONLY** by trained and qualified staff who is aware of the information contained in this Manual.

3.10 Contraindications for use

The machine must NOT be used:

- For recipients other than those listed in the "Recipients" chapter
- For uses other than those mentioned in this manual
- In environmental conditions other than those listed in chapter "Environmental Conditions"
- In use on the road, use the machine only if in possession of a valid driver's license in accordance with the regulations in force in the country of use
- Do not use hydraulic moving parts of the machine to lift people



NOTICE

For any other use of the machine, other than those mentioned above, the Manufacturer will reserve the right to revise the terms of the warranty.

3.11 Declaration of first test

Manufacturer's declaration of first test

DIECI s.r.l. declares that each machine and equipment manufactured at its plants, before placing on the market, has been subjected to static and dynamic tests designed to verify proper operation and compliance with EU directives to which it is subject.

At the conclusion of the tests performed, the CE certification of the tested machine will be issued.

Each **DIECI s.r.l.** product with CE marking is provided with the related certificate, which must be kept by the rightful owner according to the requirements of law.

3.12 Liability

- The machines and equipment are built according to the EC Directives in force at the time of sale;
- Failure to follow the instructions for use and safety or the use of the vehicle in good working order can not cause accidents criminal offense;
- The manufacturer is not liable for damage caused to persons, animals or property resulting from improper use of the machine or structural changes, unauthorized applications, and transformations;

- The manufacturer also reserves the right to make any changes to the machine for any technical and commercial requirement without notice.

3.13 Manufacturer

DIECI s.r.l.

Via E. Majorana, 2/4

42027 Montecchio Emilia (RE) ITALY

Tax Code 01283560686 VAT No. 01682740350

Tel. +39 0522 869611 - Fax +39 0522 869744

email: info@dieci.com

3.14 Certification and CE marking

The machine and related equipment are manufactured in accordance with the relevant EU directives and applicable at the time of its release on the market.

L 'analysis of all the essential safety health and requirements was carried out during the design and construction in order to verify the applicability and the consequent compliance. Where the analysis has detected an initial lack of conformity, the problems were corrected with appropriate solutions in order to satisfy these requirements.

Here following is shown a facsimile of the certification attached to the machine.

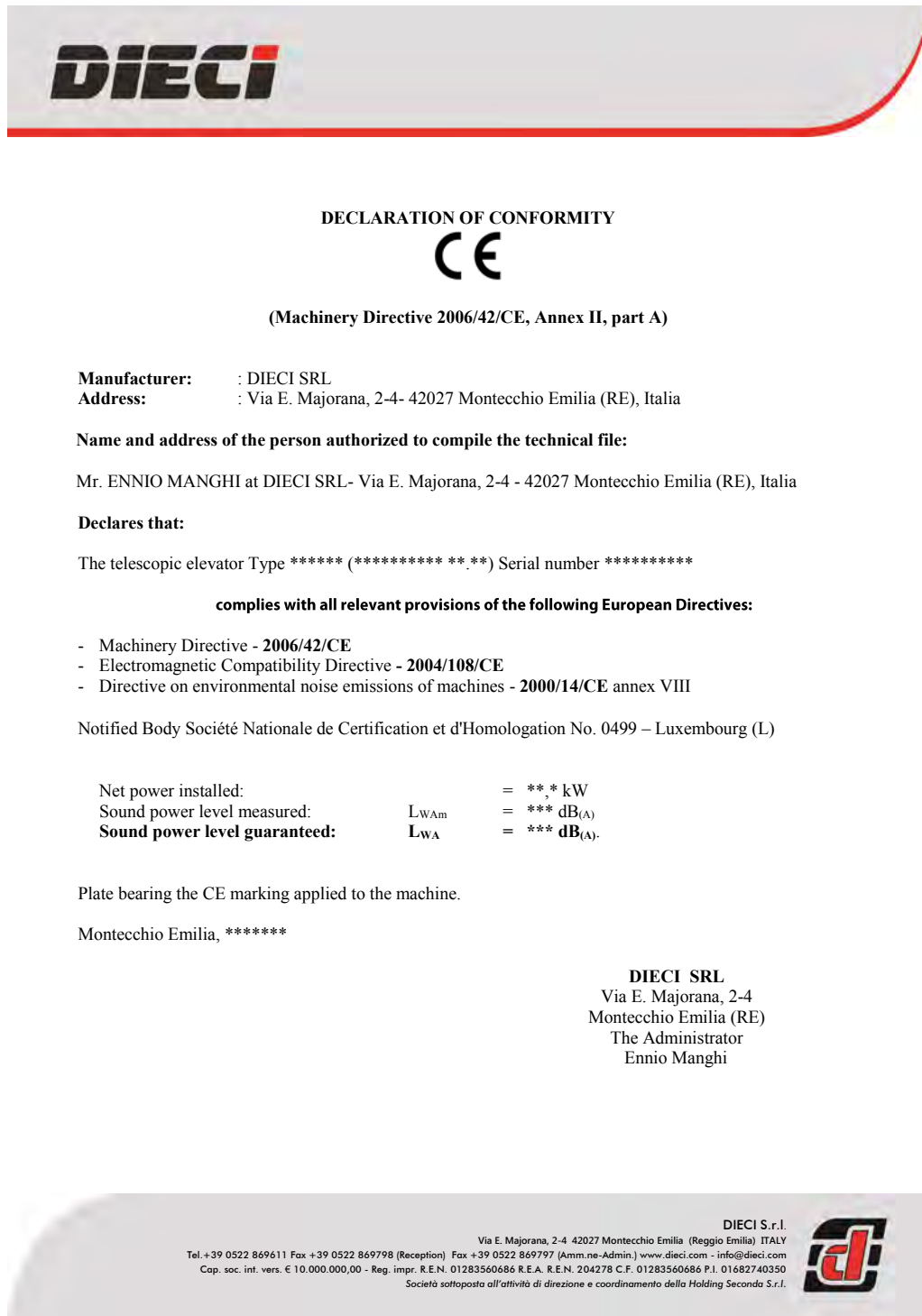

4 Warranty

4.1 Exclusions from the guarantee

Damage to the vehicle caused by the following is not included in the Guarantee:

- Operator errors
- Failure to perform the maintenance stipulated in this Manual
- Faults and/or breaks not attributable to its malfunction
- Tampering with equipment
- Normal operating wear
- Deterioration of the parts that have a purely aesthetic function
- Repairs by unauthorized centers or persons
- Product use with methods that do not comply with the warnings provided in this Use and Maintenance Manual.
- Damage caused by the unsuitability of the environment in which the equipment works and phenomena that are not caused by its normal operation
- Consumable components subject to wear: clutch, belts, brake pads, slide blocks, rollers, oil and liquids, filters, etc.
- The electrical components and systems.
- Damage caused by: climatic agents, natural disasters, vandalism, etc.
- Any other malfunction not due to a certified defect resulting from an original fault or that does not fall under the responsibility of **DIECI s.r.l.**

The following parts are also excluded from this guarantee but are covered by the guarantee of the relevant Manufacturers:

- Diesel engine
- Axles and reduction gears
- Hydraulic pumps and engines
- Tires

DIECI s.r.l. shall handle the application of the aforementioned guarantees.

4.2 Warranty: duration

The **DIECI s.r.l.** company guarantees its products for 12 months from the date of delivery to the customer user or to the Dealer/Distributor.

If the vehicle is stored for long periods by the Dealer/Distributor at the time of sale to the customer, the Service Center will reserve the right to verify guarantee activation.

4.3 Warranty: commencement

The guarantee is valid from the date the vehicle is shipped from the factory (sales to Distributors or Dealers). When delivery is handled by the Distributor or Dealer, **DIECI s.r.l.** reserves the right to verify that the guarantee start date corresponds to the shipping or delivery date on the transport document of the product being guaranteed, and/or to the invoice date, and can request original copies of these documents.

4.4 Warranty: activation

The guarantee is automatically valid from the date the vehicle leaves the factory (sale to Distributors or Dealers).

4.5 Warranty: validity

4.5.1 Guarantee in countries with assistance centers

The guarantee covers the replacement or repair of faulty parts proven defective as a result of the material used, its manufacturing or assembly

DIECI s.r.l. reserves the sole right to authorize the repair or replacement of faulty parts.

DIECI s.r.l. shall resolve the anomaly through the means and methods it deems most appropriate

DIECI s.r.l. is responsible for:

- The materials used
- Labor
- Travel expenses

The Customer is responsible for:

- Packing and shipping costs for replacement parts
- All other expenses not listed under those for which **DIECI s.r.l.** is liable.

4.5.2 Guarantee in countries with NO assistance centers

Refers exclusively to the free supply, ex works by **DIECI s.r.l.**, of parts no longer usable due to faulty original material, manufacturing and/or assembly.

4.5.3 Examining replaced faulty parts

Before granting the guarantee, DIECI may ask for the faulty parts replaced during the repairs to be returned at **DIECI s.r.l.**'s expense.

4.5.4 Additional guarantee for repairs and replacement parts

Repairs made under guarantee or not, and parts replaced during repair work, are guaranteed for 3 months from the date of repair or installation, even if the original guarantee has expired.

4.5.5 Intervention campaigns for faulty products

The replacement procedures of parts acknowledged to be faulty will be agreed upon by **DIECI s.r.l.** and its distributors/dealers/authorized workshops.

These intervention campaigns can be followed directly by **DIECI s.r.l.** suppliers, who are responsible for supplying the components to be replaced (interventions authorized by **DIECI s.r.l.**).

The above interventions will be preceded by written communication from **DIECI s.r.l.** to its purchasers.

Only **DIECI s.r.l.** can decide the intervention method (repair, replacement or modification).

4.6 Warranty: intervention request

4.6.1 Guarantee: claim

The claim of the faulty part must be made by the Customer, Dealer, Distributor or Authorized workshop and must be sent directly to **DIECI s.r.l.** Customer Service within 8 days from when it is noted.

The claim must include a clear description of the defect and precise references to the vehicle (type, model, and serial number). This information can be found on the vehicle in the places indicated in the USE AND MAINTENANCE MANUAL.

4.6.2 Obligation of vehicle downtime

If there is a risk that the defect may jeopardize safety and accident prevention or may cause further damage, the vehicle must not be used until it has been repaired and tested.

Any change made on the operating machine involve a reassessment of conformity with the Machinery Directive 2006/42/EC. This procedure also applies in the case of repairs with non-original parts.

In the event of any dispute, exclusive jurisdiction will be held by the Court of Reggio Emilia - ITALY.

4.7 Non-activation, failure to grant, termination

4.7.1 Warranty: failure to grant

The guarantee is not granted:

- If the defect is not reported as described and within the established time limit.
- If the customer does not comply with **DIECI s.r.l.** request to return the faulty parts replaced during the repairs.
- If the customer has not complied with the obligation to stop using the vehicle after making a claim, limited to damages caused by noncompliance.

4.7.2 Guarantee: termination

The guarantee is terminated:

- If the buyer does not fulfill contractual payment obligations.
- If damage has been caused by carelessness, negligence, or by use of the vehicle for purposes not in compliance with specifications provided in the use and maintenance manual (incorrect manoeuvres, overloading, use of incorrect fuel, poor maintenance, disregard for warning indicator instruments etc.)
- If the defect is a result of applications, equipment, modifications or repairs not authorized by **DIECI s.r.l.** or carried out using poor quality parts. (For this reason, we recommend always using original spare parts).



NOTICE

Refer to the "MAINTENANCE" paragraph for information regarding recommended routine maintenance.

4.8 Final terms

In none of the cases regarding non-activation of the guarantee, it not being granted or being terminated, the buyer cannot request the cancellation of the contract, or compensation, or an extension of the guarantee.

Any guarantee conditions other than those listed above must be agreed upon in writing and signed by both parties.

Unless agreed upon in writing by both parties; **Dieci s.r.l.** does not pay compensation for any type of claim caused by vehicle downtime, such as:

- Replaced or rented vehicles
- Labor
- Loss of profit

5 Safety regulations

5.1 General warnings

The instructions for use, maintenance and repair described in this handbook must be followed if the vehicle is to be considered as being operated in accordance with the manufacturer's intended uses.



DANGER

THE MACHINES AND EQUIPMENT MAY NOT BE MODIFIED WITHOUT PERMISSION OF THE MANUFACTURER.

For your safety and the safety of others, do not change the structure or adjustment of the various components of the machine or equipment. The same applies to the deactivation or modification of the safety devices present. Any changes made to the machine or equipment, holds DIECI s.r.l. harmless from any liability arising from damage or injury.

Every vehicle or equipment must be used, assisted or repaired only by persons that have received training in advance on the vehicle and on its safety regulations, in addition to being authorized to use the vehicle or equipment itself.



NOTICE

The user must always observe the general safety regulations as well as those for accident prevention, such as traffic rules if the vehicle is used on public roads (according to the regulations in force in the country of use).

DO NOT USE THE VEHICLE OR THE ACCESSORIES IF YOU ARE UNDER THE EFFECT OF ALCOHOL, DRUGS OR IF YOU HAVE TAKEN MEDICINES THAT MAY MAKE YOU DROWSY OR MAY ALTER YOUR REFLEX AND REACTION TIME.

DIECI s.r.l. is not liable for damage caused by negligent use of this vehicle or the equipment even if said damage is not a result of intentional improper use. Everything possible has been done during the design and construction phases of vehicles and accessories to make your job as safe as possible. Due caution, however, is indispensable and there is no better rule to prevent accidents.



DANGER

THE VEHICLES OR EQUIPMENT IN QUESTION ARE NOT SET-UP FOR USE IN ENVIRONMENTS OR SITES EXPOSED TO THE PRESENCE OF EXPLOSIVE GASES, THUS USE IN THESE PLACES IS PROHIBITED.

To operate in these environments, the Manufacturer must be contacted so that the necessary modifications can be made to the vehicle.



DANGER

All functions and procedures concerning the operation and mounting of the vehicle or its equipment that are not described in this manual are strictly FORBIDDEN.



WARNING

Read all of the safety stickers on the vehicle and observe all regulations printed on these stickers before starting up, running or refueling the vehicle or before carrying out maintenance work. Immediately replace damaged, lost or illegible stickers. Clean them when they are covered by mud, concrete or debris.

- Do not use the vehicle without having first read and understood all parts of this manual, and without having attended an adequate training course.
- Do not drive the vehicle when hands or shoes are wet or dirty with grease or greasy substances.
- Verify that all safety devices function before using the vehicle. The operator must always maintain control of the vehicle state and operation.
- Use the acoustic warning device or other signals to alert people in the area before starting up the vehicle.
- Inspect control instruments immediately after start up, while the engine is hot and at regular intervals during use, in order to promptly recognize and resolve any malfunctions.
- Do not start the engine or touch the machine levers if a danger sticker or a maintenance in progress sign is placed inside the cab.
- Do not carry passengers on the vehicle or in the driver's cab or on any other part of the vehicle (including passenger conveying basket).
- It is prohibited to use the mobile hydraulic parts of the vehicle to lift people except when using the passenger baskets with relative personal protective equipment for the operator inside.
- Regardless of the user's experience, become familiar with the position and function of all controls and instruments in a work area free from obstacles and persons, before operating the vehicle.
- Carry out all the described safety checks before resuming operations.
- While the vehicle is running, always keep light signals on. These serve to warn people that the vehicle is about to move.
- Always keep the safety distance adequate for the type of work and persons or objects in the work area. Always look in the forward direction and maintain good road visibility.
- Adjust movement speed based on the load carried and the type of ground; remain at low speeds to reduce the risk of the vehicle tipping over or losing the load.
- Do not drive with the brake pedal pressed.
- Do not use the vehicle force of impact to carry out tasks. These vehicles are not designed for said use; therefore, such use may cause vehicle overturning, damage, the breakage of components and attachments, or serious personal injury for the user.
- Always operate with the engine bonnet closed.
- Do not operate with the vehicle protective parts removed.
- When working in a congested area, designate one person to signal and coordinate the work zone.
- Make sure that everyone follows the directions given by the person in charge of signaling.
- Make sure to use signals that conform with the provisions in force in the country of use of the vehicle.
- For additional information with regard to the presence of a person in charge of signaling, consult the "Signals to more vehicles" chapter.
- When working alongside excavations or on the edge of the road or soft ground, keep at a safe distance as the vehicle may overturn.
 - Designate a person on the ground to be in charge of signaling.
 - Remember that after strong rains, the use of explosives or an earthquake, the ground is more fragile.
- When working on the upper part or inside buildings or other structures, verify their capacity and stability before starting operations. The risk of collapse exists and can cause serious injuries or damage.
- Working on a slope may be dangerous. The conditions of the terrain may vary according to climatic conditions (e.g. rain, snow, ice). Therefore, pay careful attention to the conditions of the terrain on which the vehicle is being used; the use of low speeds is recommended.
- Drive slowly on grass, leaves or wet steel slabs. Even when operating on slight slopes the vehicle may slip, lose balance or overturn.
- Tipping conditions of the vehicle can vary depending on the features of the ground, environmental conditions and the type of work. Complying with all the safety instructions contained in this manual reduces risks for the vehicle and the operator in most operating conditions provided herein.

- It is forbidden to use the tractor if there is any risk of tipping that is not covered herein, as this manual contains an incomplete list.

5.2 Safety indications



CAUTION

Carefully observe and follow all safety signals on the vehicle and on the equipment and read all safety messages in this manual.

- The safety signals must be installed, maintained and replaced when necessary.
- If a safety signal or this manual is damaged or missing, order a replacement from the **DIECI s.r.l.** dealer in the same way in which spare parts are ordered (be sure to communicate the model and serial number of the machine when placing the order).
- Learn how to correctly and safely operate the vehicle and the accessories and their relative controls.
- Allow only trained, qualified and authorized personnel to operate the machine and installed accessories.
- Keep the vehicle and accessories in appropriate working conditions.
- Unauthorized modifications to the vehicle or accessories can jeopardize their operation and/or safety and influence their lifespan.
- The safety messages in this SAFETY REGULATIONS chapter illustrate the basic safety procedures of the vehicles.
- In case of doubt, contact the manager before proceeding to operate or carry out maintenance work on the vehicle or on the accessories.

5.3 Personal protective equipment

5.3.1 Protective clothing

In some cases, when working in particularly uncomfortable environments, adequate clothing or equipment must be worn.



It is necessary to have:

- Protective helmet
- Safety Shoes
- Protective goggles or face shield
- Protective gloves
- Protection headwear against noise
- Reflective clothing
- Waterproof clothing
- Breathing apparatus or filtering mask

It is mandatory for the operator, before starting to work, to learn from the safety manager or the site manager which are the possible risks of the work and which accident prevention clothes he must wear.



CAUTION

Always use PPE that is appropriate for the type of work to be performed.

The Personal Protective Equipment used by the operators can have different characteristics, depending on the type of construction site and risks present in the work place.



DANGER

Danger of crushing

Pay attention to moving parts to avoid danger of crushing or dragging of the lower and upper limbs. Avoid wearing jewelry or pendants that might be trapped in moving parts. Long hair must be tied back to avoid it being caught in moving parts.

Do not wear loose clothing, chains, belts or other accessories that may be caught in the control levers or in other parts of the vehicle.



CAUTION

Keep the personal protective equipment in good conditions.

Accident prevention clothes must always be intact and in good condition. Damaged clothing cannot ensure adequate protection. Do not wear damaged clothing; always replace damaged or torn clothing before operating the vehicle.

5.3.2 Protect yourself against noise

Prolonged exposure to loud noise can damage your hearing or may cause hearing loss.



CAUTION

Always wear anti-noise earmuffs or earplugs to protect yourself from excessive and irritating noise.

5.3.3 Protections against objects falling from height

The vehicle is equipped with a protective cab against falling objecting (FOPS).



DANGER



Danger of falling objects

Use of a safety helmet is required if there is a risk of falling objects.

5.3.4 Protect yourself from flying fragments



WARNING

During operation in certain conditions, particles of material may be ejected. In such conditions, it is a good idea to wear protective goggles and clear the area of those people not in possession of such goggles.

5.4 Preparing for accidents

- Always be prepared in the event of a fire or an accident.
- Keep a fire extinguisher and first aid kit at hand. (Not supplied by the manufacturer, "optional accessories").
- Carry out periodic inspections to ensure that the first aid kit contains all necessary items; replenish content if necessary.
- To properly use the extinguisher, carefully read the instructions located on the extinguisher.
- Carry out periodic inspections and maintenance (six monthly) to ensure that the extinguisher is ready for use at any given moment.
- Create priority procedures to deal with fires or accidents.
- Keep emergency telephone numbers (doctors, ambulance, hospital and fire brigade) clearly visible and near the telephone.
- Adequately trained and educated personnel must be present for managing emergencies with adequate theoretical-practical course carried out on site.

Below are some First Aid procedures that can be activated in case of accident following use of the vehicle or equipment object of this use and maintenance manual.

These procedures may be useful in an emergency for the users or other operators present near-by, during use and various life phases of the vehicle or of the equipment (transport, installation, use, maintenance, adjustment, etc.).

5.4.1 First Aider Tasks

1. Activate first aid (emergency call).
2. Evaluate the victim and, if necessary, support vital functions.
3. Stop an external hemorrhage.
4. Protect wounds and burns.
5. Protect the victim against further damages.
6. Do not perform unnecessary or damaging actions, such as giving beverages, moving the victim, reducing dislocations and/or fractures, etc.

5.4.2 Emergency call

Good first aid intervention also depends on the timely arrival of rescuers (emergency medical support) to the place of the emergency.

This is why the first aider in charge of calling the emergency must precisely indicate:

- Address of where the accident or illness took place.
- Number of injured or ill persons.
- The possible cause of the event.
- The state of the vital functions of the injured party, specifying whether the same is conscious or not and breathes normally or not.

At the end of the call it is recommended to:

- Give own details, indicating a telephone number where to be contacted.
- Wait for the rescuers outside the company (for example, near the reception).

5.4.3 Traumas

Distortions, dislocations and fractures:

Immobilize the joints in the position after the trauma, using bandages or storage, supporting the analgesic position of the injured party without attempting dangerous manoeuvres. Apply the cold (with bag of ice or other systems). In case of exposed fracture, cover the wound using a sterile gauze pad, after having pressed at a distance on the specific points the relative hemorrhage.

Contusions, crushing:

In case of contusions and/or crushing of ends of the upper and lower limbs (fingers, hand, feet, etc.) it is advised to immediately place the limb underneath running water (cold) and apply ice. Also check for wounds and/or cuts in the hit area and, if necessary, disinfect with the due precautions.

5.4.4 Hemorrhages

It is necessary to press the fingers on the hemorrhage point with sterile gauze pad, lifting the limb and eventually compress upstream of the hemorrhage with tourniquet

Treating superficial wounds:

Carefully expose and clean the wound, disinfect it with physiological solution, medicate it covering it with sterile gauze pads. Bandage avoiding excessive tightening to allow good circulation.

Treating deep wounds:

It is a priority to protect yourself against the risk of infection using gloves and splash shield; pad the hemorrhage by direct pressure or using other pressure points until it stops or the arrival of the ambulance. Call the medical emergency number, informing them that you are padding an arterial hemorrhage.

Treat the wound only after the hemorrhage is under control.



CAUTION

Do not use cotton wool, methylated spirit, antibiotic powder to disinfect the wound.

5.5 Preventing fires and accidents

5.5.1 Risks of fires



DANGER



Danger of fire

It is forbidden to smoke or use naked flames during use of the vehicle or any maintenance operation.

Do not operate the vehicle without the following safety conditions:



DANGER

Fuel, oil and lubricant leaks can trigger fires and cause serious injuries.

- Ensure that there are no flammable liquids leaking.

- To avoid oil or diesel leaks, make sure that there are no loose or missing clamps, no twisted tubes and no tubes that rub up against each other.
- Do not bend any tubes/pipes under pressure.
- Never install damaged tubes.
- Do not weld tubes or pipes containing inflammable liquids.
- Do not use a torch head to cut tubes or pipes containing inflammable liquids.



DANGER

Short circuits may cause fires.

- Ensure that there are no short circuits.
- Clean and interrupt all electrical connections.
- Check before each work shift that there are no loose, twisted, hardened or damaged wires.



DANGER

Fuel, oil, grease, waste, deposits or accumulated dust or other components can cause a fire.

- Remove inflammable materials.
- Prevent fires by inspecting and cleaning the vehicle at every shift, by immediately removing inflammable components.
- Check the ignition switch: in the event of fire, failure to switch off the engine will obstruct the work of the Fire Brigade.
- Do not use naphtha, petrol or inflammable liquids to clean parts of the vehicle. Only use non-flammable detergents.



DANGER

Safely handle dangerous liquids

- Handle fuel with care, it is easily inflammable. If fuel is ignited, there may be an explosion and/or a fire.
- Do not refuel the vehicle while smoking and in presence of naked flames or sparks.
- Always stop the engine before refueling the vehicle.
- Fill up the tank outside.
- All fuels, most lubricants and some anti-freezes are inflammable.
- Preserve the flammable fluids away from fire hazards.
- Do not burn or drill pressurized containers.
- Do not keep cloths soaked with lubricant; they may cause fires and spontaneous combustions.

5.5.2 Risks of inhaling gas



DANGER

Exhaust engine gases are toxic and can cause damages to your health.

If necessary to work in closed ambients, ensure it is sufficiently ventilated and equip the vehicle with special purifiers.

5.5.3 Risks of batteries exploding



DANGER

The gas of the batteries may explode.

- a) Keep any sparks, open flames or lit cigarettes away from the upper part of the battery.
- b) Never place a metal object between the terminals to check the battery charge. Use a voltmeter or a densimeter.
- c) Do not create sparks in the battery connection during recharging phases or starting the engine with auxiliary battery.
- d) Do not charge the batteries if they are extremely cold, extremely hot or damages as they might explode.
- e) Heat the batteries up to 16°C.
- f) The electrolyte in the batteries is an extremely corrosive acid.
- g) Should the battery explode, the electrolyte may be sprayed in the eyes with the possibility of causing blindness.
- h) Ensure to be wearing protective goggles when carrying out maintenance on the batteries.
- i) Do not overturn or tilt the battery as acid could come out.

5.5.4 Residual risks



DANGER

Damage may be caused by entanglement in moving parts.

Keep away from moving parts.



DANGER

Avoid burns.

Damage may be caused by entanglement in moving parts.

Jets of hot fluids:

After operation, the engine cooling liquid is hot and under pressure. Contact with hot water or steam may cause serious burns.

Avoid possible injury caused by hot water jets. Do not remove the radiator cap until the engine has cooled down. To open it, unscrew the cap as far as possible. Before removing the cap, release all of the pressure.

Hot surfaces and fluids:

The engine, reduction gears and hydraulic system oil heat up during vehicle use. The engine, rigid and flexible piping and other components heat up.

Wait until all parts cool down before beginning maintenance or repair work.



DANGER

Caution with pressurized fluids.

Fluids such as fuel or hydraulic oil under pressure can penetrate the skin and eyes causing serious injuries.

Avoid these dangers while repairing or carrying out maintenance on the vehicle, discharging the pressures (using the hydraulic levers of the distributors) before disconnecting or repairing pipes and hydraulic parts.

Before restarting the engine, ensure that all connections have been correctly tightened.

Use a piece of cardboard to check for any leaks; make sure your hands and body are adequately protected against pressurized fluids. Wear a face mask or accident-prevention goggles to protect your eyes.

Should there be an accident, seek medical attention immediately. Any fluids that penetrate the skin must be removed surgically within a few hours to avoid infections.



DANGER

Electrocution

All maintenance and/or adjustment interventions on powered parts must be carried out only and exclusively by qualified and adequately trained personnel.



DANGER

Risk of slipping.

During on-site operations, the areas around the equipment may have debris and liquid (oil, water, etc.) that might make the floor slippery. Pay the utmost attention.



DANGER

Risk of falling, tripping.

Pay the utmost attention when climbing in and out from the vehicle.



DANGER

Crushing of hands and feet.

The presence of moving parts during functioning can cause risks for the ground operators. During vehicle movements, carefully check no unauthorized person is within the required moving area.

5.5.5 Contact with dangerous substances

- Wear the necessary protective clothing.
- Refer to the safety data sheet of the product used and take appropriate precautionary measures when using the product.
- Avoid contact with skin and eyes
 - In case of contact with eyes: rinse them thoroughly with plenty of water for a few minutes keeping the eyelids open and seek medical attention.
 - Should any fluid come into contact with skin, wash the area carefully, remove contaminated clothing, and when skin is dry, apply moisturizing cream. Consult a doctor if necessary.
 - In the event of inhalation, move away from the contaminated area and go to a well-ventilated location. Consult a doctor in the event of respiratory problems.
 - If swallowed: immediately contact a doctor, showing the label or container. Do not induce vomiting to avoid the risk of inhalation via respiratory passageways.

5.6 Storing dangerous liquids



DANGER

Flammable material danger.

All fuels, most lubricants and some anti-freezes are inflammable.

Handle fuel with care, it is easily inflammable. If fuel is ignited, there may be an explosion and/or a fire.



WARNING

All fluids must be kept out of the reach of children and incompetent persons.



WARNING

Different types of substances must not be stored or mixed together.



DANGER

All chemicals are generally very harmful to health.

Avoid contact with skin and eyes by wearing appropriate protective clothing; do not swallow.



DANGER

It is forbidden to smoke and have open flames

It is forbidden to smoke or to use naked flames near fuels.



Comply with the following precautions to store dangerous liquids:

- All inflammable fluids must be stored in special containers, and the content of the containers must be clearly indicated. Containers must be tightly sealed.
- Store inflammable fluids in well-ventilated locations, far away from heat sources, sparks and open flames.
- Keep containers closed and covered. Other substances (e.g. foodstuffs) must not be present in this location.
- Always fill up the tank outside.
- Be careful of fumes and steam which may be formed by chemical products. Avoid inhalation.
- Do not breathe in fuel fumes.
- Ensure that these chemical products do not spill or flow into the ground, sewers or puddles. If necessary, inform the competent local authorities.
- In the event of a fire, use carbon dioxide, dry chemical powder, foam, sprayed water, sand, earth. Use jets of water to cool down surfaces exposed to the fire.
- Verify that there are no leaks of inflammable liquid (fuel, oil, grease, general lubrication leaks) in the storage containers.



NOTICE

Refer to the safety data sheet of the product for additional precautions and warnings that are to be adopted.

5.7 Warnings for safe working

5.7.1 Ensuring the vehicle is clean

- Clean the windows, lights and rear-view mirrors
- Clean dirt and waste away from the engine, joints and radiator
- Make sure the cab steps and the handle are clean and dry
- Clean all safety stickers and manoeuvring instructions. Replace any stickers that are illegible or missing



WARNING

If the vehicle or equipment is not in perfect working order its operation is strictly prohibited.



NOTICE

For the cleaning procedures, refer to the "CLEANING" chapter.

5.7.2 Checking for damage

- Make sure there are no damaged or missing parts
- Make sure all articulated pins are properly fastened
- Make sure there are no signs of possible cracks or flaws or other damage to the windows
- Make sure there are no oil, fuel or cooling liquid leaks underneath the vehicle
- Make sure the wheel bolts are properly tightened



WARNING

If the vehicle or equipment is not in perfect working order its operation is strictly prohibited.

5.7.3 Start working with the vehicle

Regardless of their level of driving experience, operators must familiarize themselves with the position and function of all controls and instruments before operating the machine.

- Before using the vehicle, check location of personnel.
- While the vehicle is running, always keep light signals on. These serves to warn people that the vehicle is about to move.
- When working in a congested area, have another person present for signaling.
- When manoeuvring the vehicle, pay attention to bulky vehicle parts. There are parts that jut out from the cab.
- Never use controls for purposes different than those for which they were created for; e.g. to climb on or off from the vehicle or hang clothing, etc...
- Only use the vehicle from the driver's position
- The vehicle may move suddenly if started up without following the correct procedure, thus, creating the risk of personal injury.
- Start up the engine from the driver's seat only.
- Never start the engine by causing a short circuit between the terminals of the starter.
- Before starting the engine, make sure all control levers are in a neutral position.

5.7.4 Passengers transportation

Only the operator must be on board the vehicle, passengers are not admitted.

Passengers may obstruct the operator's view, causing an unsafe operation of the vehicle.



WARNING

Carrying people on or lifting people up with the vehicle is strictly prohibited unless the vehicle is equipped with an elevation work platform and has a special certificate of conformity regarding the transport of people.



WARNING

It is strictly forbidden to transport persons inside the basket while the vehicle is moving even in the presence of elevation work platform and certificate of conformity. It is compulsory to use the basket only with the parking brake engaged and the outriggers lowered (if present).

5.7.5 Electrical system protection

A burnt fuse must be replaced with another fuse of the same type, amperage and class.

Other types of interventions are not allowed, even if temporary.

Do not connect or remove terminals, fuses, or connectors when the vehicle is switched on or electrically powered.

Any intervention on the electric plant must take place with the vehicle not powered electrically. Restore the power supply only after the intervention has been concluded. Remount the lids and protections.

- Use the battery isolator to cut off power to the vehicle.
- Cut off power by means of the battery cut-off even before replacing the vehicle battery.
- In the event that a connector is damaged or is no longer inserted in its housing, replace it immediately in order to avoid short circuits or sparks.

Damaged, pinched or burnt cables must be replaced immediately even if damage is only to the sheathing or outer insulation.

- Never carry out or interrupt any connection on the load circuit, including connections on the battery, with the engine running.
- Never ground (earth) short circuit any charging component.
- Do not use an auxiliary battery with nominal voltage exceeding 12 volt.
- Make sure the polarity is correct when putting in the battery or when using an auxiliary battery when starting the vehicle with cables. Follow the use and maintenance instructions of the manual when starting up the vehicle with cables.

Always disconnect the negative cable from the battery before performing arc welding on the vehicle or on any connected attachment.





- Position the welding machine's ground terminal as close as possible to the area to be welded.
- If welding is to be carried out near an electrical module, this module must be removed from the vehicle.
- Only qualified and authorized personnel should carry out this operation.
- Do not allow welding machine cables go above, near or cross over any electrical cable or electronic component while welding is in progress.





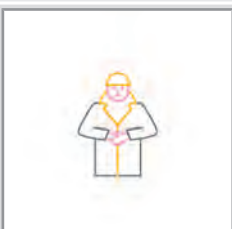
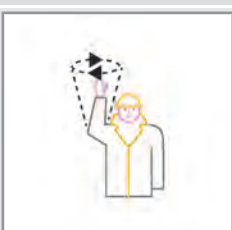

5.7.6 Signals to multiple vehicles

When working requiring more vehicles, give signals normally known to all employed personnel. Designate one person to signal and coordinate the work zone.

Before operating make sure that:

- The user and signaler are aware of the hand signals to be able to interact between them
- That everyone follows the directions given by the person in charge of signaling
- The signaler must be easily identified by the user of the vehicle
- The signaler must wear or hold one or more adequate recognition elements, like: jacket, helmet, sleeves, bracelets, signal paddles
- The recognition elements must be bright colored, preferably one, and reserved exclusively for the signaler.

Movement	Meaning	Description
	Start - Attention - Order taking	The two arms are open horizontally, the palm of the hands forward
	Stop - Interruption - End of motion	The right arm is stretched upwards, with palm of right hand forward
	Danger - Stop - Emergency stop	Both arms stretched upwards
	End of operations	The two hands are joint at height of chest
	Lift	The right arm, stretched upwards, with palm of right hand forward, makes a circle
	Lower	The right arm, stretched downwards, with palm of the hand towards the body, makes a circle

Movement	Meaning	Description
	Vertical distance	The hands, one on top of the other, indicate the distance
	Horizontal distance	The hands, one next to the other, indicate the distance
	Forward	Both arms are folded, the palms of the hands backwards and the forearms make slow movements towards the body
	Move back	Both arms are folded, the palms of the hands forward and the forearms make slow movements away from the body
	To the right compared to operator	The right arm, stretched horizontally, with palm of right hand downwards, slowly makes small movements towards the direction where to move
	To the left compared to operator	The left arm, stretched horizontally, with palm of left hand downwards, slowly makes small movements towards the direction where to move
-	Quick motion	The conventional signals used to indicate movements are quickly made
-	Slow motion	The conventional signals used to indicate movements are made very slowly

5.7.7 Working with the danger of falling masses and objects

When working in areas where there is a risk of falling, bouncing or interference from objects capable of hitting the operator or entering the cab:

- Mount suitable safety panels to protect the operator
- Always close windows
- Always ensure that other operators near-by are at a safe distance and cannot be hit by bouncing or falling objects.
- Pay careful attention to crumbling walls, landslides, falling material or objects from the installed equipment, that may hit the cab, the protective structure or windows, causing damages to the vehicle and to the operator.
- Never carry out work operations under an overhang; this could give way and fall onto the vehicle.
- Do not excessively weigh down or fill the installed equipment or transport loads that may come out or fall on the ground.



WARNING

Danger of falling objects

Use of a safety helmet is required if there is a risk of falling objects.

5.7.8 Working near electrical lines

Before working near overhead electrical lines, check that the safety distance is sufficient, in compliance with the current Standard in the country of use. In any case, never work near electrical lines at distances shorter than those in the table below or at the minimum distances indicated by the Standards in force in the country of use of the vehicle.

Damp ground may increase the risk of electrocution.

Operating or parking the vehicle too close to electrical cables leads to increased risk of being struck by lightning or being seriously injured.

Designate someone on the ground to signal when too close to power lines.

Do not allow anyone near the vehicle when working in the vicinity of power lines. To prepare for any possible emergency situation, wear rubber shoes and gloves, cover the seat with a rubber piece of fabric and take care not to touch the chassis with any unprotected body parts.



DANGER

High voltage danger

Should the vehicle collide with an electrical cable, the user, to avoid electrocution, must remain inside the driver's cab until certain that the electrical power supply has been properly disconnected.



DANGER

High voltage danger

If operating close to overhead electrical lines, check the safety distance in the table below, reported in the Italian Legislative Decree 81/08 Enclosure IX. The table is valid if the vehicle is used on Italian territory. However, refer to the Standards in force in the country of use of the vehicle.

Un (kV)	Distance
≤ 1	3 m (9.84 ft)
1 < Un ≤ 30	3.5 m (11.48 ft)
30 < Un ≤ 132	5 m (16.40 ft)
> 132	7 m (22.96 ft)

5.7.9 Working under the snow

Snow can hide obstacles and objects, and cover holes, dug-out areas and ditches, therefore, proceed with caution.



WARNING

Operation of the vehicle if the quantity of snow does not allow for clear distinction of obstacles and possible dangers along the path, is strictly prohibited.

- Take care when clearing snow and do not venture off the main road; that which is hidden at the sides of the road may cause vehicle overturning or damage to various components.
- Surfaces covered by snow or ice are extremely dangerous. Operate with caution, reducing vehicle speed as much as possible and engaging levers slowly.
- Operate with caution. If the vehicle should sink into the snow, it may overturn or remain buried. Do not venture from the road and avoid remaining entrapped or buried under heaps of snow.
- Extra care should be taken, when working on icy terrain. The ice will melt as the temperature rises and the ground will become slippery.
- Use caution in the presence of electrical cables, ditches, or freshly excavated or worked ground.
- Make sure not to cause risk to others in the area when backing up the vehicle.
- Always check the space around the vehicle before carrying out any manoeuvres



NOTICE

If working the vehicle at low temperatures (-10°C), empty and refill the tank using lubricants, fuel or cooling liquids suitable for such temperatures.



NOTICE

There are accessories that can be used to facilitate working with ice or snow, contact your dealer or agent.

5.7.10 Working with scarce lighting



CAUTION

The standard illumination of the vehicle is not suitable in working conditions with poor visibility or for use at night.

The vehicle can only be used with sufficient lighting in the work area.



NOTICE

There are several ways to improve visibility in conditions of poor lighting. Contact your local **DIECI s.r.l.** dealer.

5.7.11 Working in closed areas or dangerous atmospheres

It is FORBIDDEN to use the machine in:

- Suitably ventilated closed spaces, that are nevertheless not compatible for the use of equipment with running endothermic engines.
- Spaces with dangerous or explosive atmospheres.

- Protected environments such as refineries.



CAUTION

The vehicle must be appropriately modified and certified to work in environments with an explosive atmosphere.

The vehicle can only be used in a tunnel if it has been declared suitable for these environments.

5.7.12 Reduce vibrations

Consider the following recommendations to reduce the vibration exposure of the operator:

- Always use the appropriate equipment for the job to be carried out.
- The driver's seat must be properly adjusted to suit the operator needs. Inspect and if required repair the suspensions and the regulation mechanisms of the seat.
- Make sure that the machine is kept efficient, perform machine maintenance as prescribed in this manual.
- Steer, accelerate, brake, shift gears, move the tool in a non-abrupt way.
- During transfers adjust the speed of the machine to minimize the level of vibrations. Reduce speed to avoid the risk of jolting. Transport the machine in the event of significant distance between job sites.
- Maintain the workplace in good condition, remove stones and obstacles, fill depressions or holes etc.
- To avoid back pain problems, use the machine only in good health.
- Take breaks so as to reduce the time of sitting in the same posture.
- Do not exit the cab or go out of the machine with a jerk.
- Avoid to lift and move loads repeatedly.

5.8 Working in windy conditions

Wind speed variation can cause a number of problems including the loss of vehicle stability, load oscillation, and a decrease in visibility due to dust, leaves, etc.

Adverse factors to vehicle use are:

- Location of the work site, the aerodynamic effect of buildings, trees and other structures influence wind speed.
- The height of the extended boom: the higher the boom is raised vertically, the higher wind speed becomes.
- Load bulk area: the more space the load occupies, the more the wind force is felt.

Strong wind

DIECI telehandlers can be used up to a wind speed of 45 km/h (12.5 m/s) Km/h, equal to 12.5 m/s (No.6 on the Beaufort scale) measured on the ground.

At 10°C temperature, wind with a speed of 32 km/h (8.9 m/s) Km/h it seems that exposed parts of the body have a temperature of 0°C. The higher you climb the faster the wind speed and the more the sensation of pressure drop increases.



WARNING

Strong wind danger

In the presence of strong winds (no.5 Beaufort scale) never lift loads with surfaces exceeding 1 m².

Below you can find the graph of the Beaufort scale for an indication of the wind speed with which you are working and when to suspend operations, if wind speed should exceed determined values.

Beaufort Wind Scale			
No.	Definition	Indicators	Speed (m/s)
0	Calm	Smoke rises vertically	0 - 0,2
1	Light air	Smoke drift wind direction	0.3 - 1,5
2	Light breeze	Wind felt on exposed skin. Leaves rustle; vanes begin to move	1.6 - 3
3	Gentle breeze	Leaves and small twigs constantly moving; light flags extended	3 - 5
4	Moderate breeze	Dust and loose paper raised. Small branches begin to move	5 - 8
5	Fresh breeze	Small trees in leaf begin to sway; glassy water, small waves form	8 - 11
6	Strong breeze	Large branches in motion. Whistling heard in electrical wires. Umbrella use becomes difficult	11 - 14
7	Strong wind	Whole trees in motion. Effort needed to walk against the wind	14 - 17
8	Fresh gale	Some twigs broken from trees. Cars veer on road	17 - 21
9	Strong gale	Slight damage to buildings (falling chimneys and tiles)	21 - 24

5.9 Assessing the consistency of the work ground

The ground on which the vehicle can be positioned must be able to support the vehicle and its maximum bearing capacity.



DANGER

Danger of tipping

The sinking of the machine base support may cause the vehicle tilting.



CAUTION

Contact a qualified technician to assess the consistency of the ground according to the regulations in the country of use of the vehicle.

Request in any case the advice of a qualified technician to know whether in the workplace, there are hidden cavities (pipes, wells, old tanks, basements, manure, etc...).



NOTICE

Refer to the "*Technical data*" chapter in the manual of the vehicle, to know the maximum load that each wheel or outrigger (if any) can apply on the ground while using the vehicle.

5.10 Moving safely



NOTICE

The following operations are standard for any type of installed equipment; however, refer to any warnings present in the equipment manual.



WARNING

In the event of scarce visibility, have a person operate on the ground for signaling.



WARNING

Do not lift or lower the loads when the vehicle is in motion.

Operating on sloped terrain can cause overturning or sliding. Move forward and brake gradually and take all necessary cautions.

Always move in a straight line to go up or down a slope. Moving transversally or along the slope is extremely dangerous (fig. 150533-1).

Always use the parking brake when setting down or lifting a load on a slope.

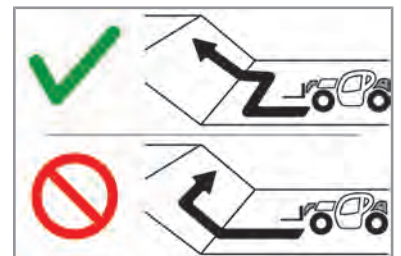

150533-1



WARNING

Check the vehicle is leveled before using the boom on sloped ground.

Do not stop and leave the vehicle parked on a slope exceeding 15%, even with the parking brake engaged.



150534-1

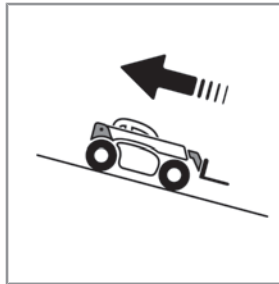

150534-2

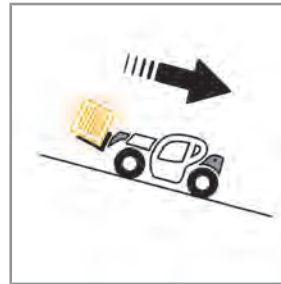

150534-3

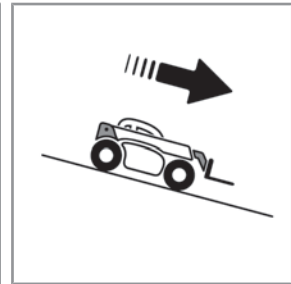

150534-4

- In the event of having to travel uphill while transporting a load, operate always maintaining the load towards the top of the uphill (fig. 150534-1).
- When having to drive uphill without a load, operate with the vehicle facing downhill (fig. 150434-2).
- In the event of having to travel downhill while transporting a load, operate always maintaining the load towards the top of the uphill (fig. 150434-3).
- When having to drive downhill without a load, operate with the vehicle facing downhill (fig. 150534-4).

5.11 General warnings for moving the load

NOTICE! For safe working procedures in the various working conditions refer to the "Safety standards" chapter.

Always adhere to safety regulations; always transport balanced, properly arranged load to prevent overturning.



CAUTION

It is strictly prohibited to work without the respective capacity diagrams for the equipment and the vehicle.

When using this vehicle, carefully follow the capacity diagrams of the vehicle with the equipment mounted at that moment.

Always adhere to safety regulations; always transport balanced, properly arranged load to prevent overturning.

Do not attempt to carry out operations which exceed the capacity of the assembled equipment or of the vehicle.

Do not modify the structure and vehicle stability in any way by trying to add counterweights, whichever artifact is used.

Always ensure the pallet, the boxes and other supports for the load are in good conditions and adequate to the load to be lifted; the sudden collapse of a rack of material is often caused by a faulty pallet.

Do not move the load with boom lifted or extended.

- Handle the vehicle with the boom raised only in exceptional circumstances. In these circumstances, operate with due prudence, reduce speed as much as possible and brake delicately. Make sure that visibility is always sufficient. If necessary, ask an operator on the ground to guide you for the operations.
- Reduce the speed as much as possible and brake gently during handling operations.



WARNING

Do not handle loads while the vehicle is moving.

Avoid passing over unstable objects. Remove dangerous, unstable objects instead of passing over or around them. Also avoid holes and ditches that might make the load jolt.

Before turning, slow down as much as possible, and monitor the load.

Do not change direction abruptly or at high speed.

Remember that hydraulic steering is very sensitive to steering wheel movements; steer gradually and avoid sudden movements.

Slow down before turning.

Pay attention to the side space, in particular if transporting wide loads. If possible, keep to the center of the passage to avoid equipment or personnel from obstructing your path.



WARNING

Handle loads with care, at low speed and without sudden or jolting movements, above all if they are carried at great heights.

- Always ensure good visibility in the work area, including direct vision and visibility using rear view mirrors in order to check for the presence of people, animals, obstacles, holes and changes in slope etc.
- Decrease the working speed of the vehicle in case of rain, fog, snow or in any case where visibility is reduced.
- If visibility on the right side is limited during boom operation, before lifting the load, ensure that the work area is clear and make note of the position of any possible obstacles and irregularities in the terrain.
- Always make sure there is good visibility (clean windows, clean mirrors, clean lights that work properly, etc.).
- Maintain control of the vehicle and its speed in all circumstances. The speed of the loaded vehicle must never exceed 10 Km/h. If the load exceeds the maximum allowed load by 50%, vehicle speed must be reduced to 5 Km/h.
- Do not drive in reverse for long distances.
- Brake gradually; avoid braking abruptly.
- Always maintain the safe distance from other vehicles in order to have sufficient space to brake in every condition.

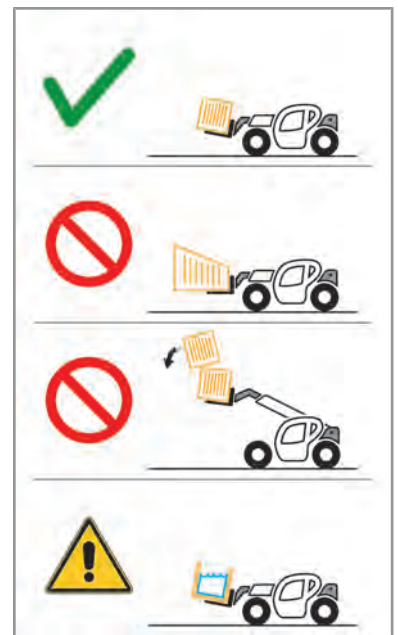

150532-1

- Always ensure good visibility in the work area, including direct vision and visibility using rear view mirrors in order to check for the presence of people, animals, obstacles, holes and changes in slope etc.
- Decrease the working speed of the vehicle in case of rain, fog, snow or in any case where visibility is reduced.

- If visibility on the right side is limited during boom operation, before lifting the load, ensure that the work area is clear and make note of the position of any possible obstacles and irregularities in the terrain.
- Always make sure there is good visibility (clean windows, clean mirrors, clean lights that work properly, etc.).
- Maintain control of the vehicle and its speed in all circumstances. The speed of the loaded vehicle must never exceed 10 Km/h. If the load exceeds the maximum allowed load by 50%, vehicle speed must be reduced to 5 Km/h.
- Do not drive in reverse for long distances.
- Brake gradually; avoid braking abruptly.
- Always maintain the safe distance from other vehicles in order to have sufficient space to brake in every condition.



CAUTION

Before lifting loads, operators must be familiar with the weight of the load and its center of gravity.

- Transport the load as close as possible to the ground. Keep the load low, at a height from the ground of 300 mm. Never move with the load lifted more than necessary.
- The load diagrams are valid for centers of gravity of standard loads. For particular loads, contact your dealer.
- Pay the utmost attention during transporting of loads with variable center of gravity (e.g. Liquids). Operate with caution in order to limit such variations and to prevent the risk of vehicle overturning.
- Always ensure the moved load is correctly balanced and cannot fall on the ground. The loss of the load or part of it can entail a danger of damage to things and persons
- Pay the utmost attention to objects that may fall. Ensure there are no unstable objects on the upper part of the load.



WARNING

Never lift a load when the vehicle is on a sloped surface. When on a sloped surface, pay attention to the conditions of the ground. When working with the vehicle on a sloped surface with the load high, a jolt or a hole is sufficient to make the vehicle overturn.

Do not move the boom if the vehicle is located on terrain with a slope greater than 2° (3.5%).

5.12 Use of cables, ropes and slings

It is strictly forbidden to lift or move load fastening ropes or chains only to the vehicle's accessory holder plate, to forks or to any other equipment not designed for this purpose.

Various equipment set-up for lifting, provided with suitable hooks for the use of cables, chains and straps are available. For further information contact your **Dieci** dealer.

To keep the suspended load from swaying while being handled, the load can be fixed to the anchoring eyebolts of the vehicle while being transported.

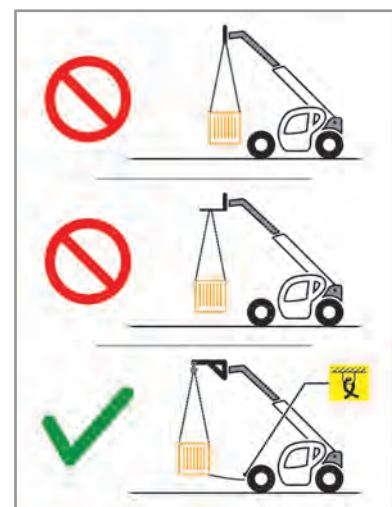

150535-1

5.13 Road travel

5.13.1 Road travel warnings



CAUTION

Before starting the road travel make sure to observe the relevant laws and regulations in the country of use.

The road travel requirements are shown on the Vehicle Registration Document.

Low beam lights must be on even during the day and in streets where there is no obligation to use visual and lighting signaling devices.

Ensure correct operation and cleaning of headlights, direction lights and windscreen wipers.



WARNING

Check the correct position of the rear view mirrors.

The objects seen through the rear view mirror are closer than they appear.

When driving on the road and/or on a slope it is necessary to be very careful to the engine rpm. A high number of rpm can lead to mechanical failures. Keep under control the motor rpm and speed.

Pay particular attention to loading docks, trenches, scaffolding and land recently excavated or filled

5.13.2 Road travel instructions

- Level the vehicle so that the wheel axles are aligned with the chassis (if present).
- Ensure that all outriggers have been perfectly retracted and raised (if present).
- Close the telescopic arm (boom) completely.
- Lower the telescopic boom completely and then raise it slightly to about 20-30 cm from the ground.
- Check the correct operation of the lights before moving on roads. Check that the rotating light for slow vehicle signaling is installed and running; keep the rotating light in operation both at day and at night.
- Perform the wheels alignment, so that they are perfectly aligned with the vehicle chassis.
- **It is mandatory** to arrange the steering as reported in the Vehicle Registration Document and lock the selector lever with the dedicated device.
- Make sure that the amount of fuel is sufficient.
- Assemble all the accessories required for road circulation depending on the country in which the vehicle is operating.
- Install an overhanging load signal panel on the boom head before the entering onto the road.
- Always evaluate the road to be traveled, taking account of suspended structures (e.g. bridges, underpasses, etc.) that could be damaged by the vehicle.
- In some countries it is mandatory to place wedges under the tires when the vehicle is stopped.

- Make sure that your vehicle is in compliance with local legislation in reference to the presence of the license plate when traveling on the road both at day and at night.



WARNING

Road transfer with equipment assembled to the fork holding plate is not allowed except those accepted by the legal authority of the country where the vehicle operates.



WARNING

It is not allowed to travel on public roads with loaded vehicle.

Comply with the maximum permissible mass written on the vehicle registration document.

5.14 Momentary stop



CAUTION

If it is necessary to leave the driving position, follow the steps in the "Parking the vehicle" paragraph.



WARNING

Never move away from the vehicle, leaving the engine running or the ignition key on the vehicle.



WARNING

Do not stop and leave the vehicle parked on a slope exceeding 15%, even with the parking brake engaged.

- Gradually release the accelerator pedal.
- Stop the vehicle on even ground.
- Engage the parking brake
- Bring the movement selection lever to "N".
- During the running-in of the vehicle (50 h), do not keep the diesel engine at minimum revs for too long.

5.15 Parking the vehicle

Never leave in any case the vehicle parked with a raised load.

- Always park on flat, firm and level ground, where there is no risk of falling rocks, landslides or flooding.
- Lower outriggers to the ground (if present).
- Retract the boom completely and lower it to the ground.
- Engage the parking brake
- Bring the movement selection lever to "N".
- Run the engine at idle speed for some seconds before turning it off, in order to allow the engine cooling.
- Turn the ignition key to the engine stop position.



150536-1

- Remove the key from the ignition switch.
- Lock the hydraulic controls with the special devices (if present).
- Close the windows and lock them with the handles.
- Close the cab door by key.
- Place wedges under the wheels.
- Make sure that the vehicle is parked so as not to impede its movement and at least 5 meters away from the railroad tracks.

**WARNING**

Do not stop and leave the vehicle parked on a slope exceeding 15%, even with the parking brake engaged.

5.16 Starting and stopping the machine

5.16.1 General warnings regarding starting up the vehicle



CAUTION

Do not use the vehicle without having first read and understood all parts of this manual, and without having attended an adequate training course.

- Before starting the engine, make sure all control levers are in a neutral position, the parking brake is engaged, the engine hood is closed and that there is nobody in the area surrounding the machine.
- The machine can only be started up or maneuvered when the operator is seated in the driver's seat, with the seat belt fastened and adjusted.
- The machine may move suddenly if started up without following the correct procedure, thus, creating the risk of damage.
- Never start the engine by causing a short circuit between the terminals of the starter.
- Never start-up the engine by pushing or pulling the vehicle. This could seriously harm people or cause serious damage to the vehicle.
- Be careful when using auxiliary batteries as the gas contained in these may explode, causing serious damage. Follow the instructions provided in the "Emergency procedures" chapter, "Start-up using auxiliary batteries" paragraph to start the engine using auxiliary batteries. An incorrect procedure can cause serious damage to the electrical/electronic system, the vehicle could move suddenly, the battery could explode and damage could be caused to objects and/or people.
- Do not start the engine or touch the levers of the machine if a danger sticker or a maintenance in progress sign is placed inside the cab.

5.16.2 Inspections prior to starting-up

5.16.2.1 Inspecting the machine

Carefully inspect your machine every day or before every shift.

Carry out the following inspections and operating checks:

- Parking brake efficiency
- Intact condition of the tires
- Type of tire suitable for the type of work ground
- Engine oil level (check and top-up, if necessary)
- Hydraulic oil level (check and top-up, if necessary)
- Air filter clogging indicator (check and clean, if necessary)
- Tire inflation and pressure (check)
- Fuel level (check)
- Signaling and warning devices (check)
- Steering efficiency
- Service brake efficiency
- Tightness of all nuts and bolts
- Lighting
- Direction indicators
- Emergency Lights

- Switches
- Indicator lights
- Windscreen wipers
- Reverse movement alarm
- Position and condition of rear view mirrors



DANGER

Immediately stop using the machine in case of malfunctions or if it does not comply with safety standards.

Contact an authorized *Dieci s.r.l.* workshop if the machine shows malfunctions. Refer to the "Maintenance" chapter for information regarding routine maintenance.



NOTICE

A thorough inspection is required if the machine is not used for a prolonged period of time. A detailed description of the operations is provided in the "Machine storage" chapter.

5.16.2.2 Inspecting the work area

- Examine the work area when working at the edge of an excavation or on soft ground as the machine could overturn.
- Examine the conformation and condition of the terrain of the work area before beginning to operate.
- Keep the machine well away from the edge of the excavation and the side of the road.
- When working on a slope or near the roadside, have another person present for signaling.
- Pay utmost attention when working on icy ground. The ice will melt as the temperature rises and the ground will become slippery.
- Check for any overhead power lines or underground piping.
- Do not work in places at risk of landslides or falling rocks.
- Take due precautions to prevent any unauthorized persons from entering the working area.
- When moving through or operating in shallow water or soft ground, verify the shape and the conditions of the land, the water depth and flow rate before beginning the operation.

5.16.3 Starting-up the engine

Proceed as follows to start-up the engine of the vehicle:

1. Press the parking brake switch.
2. Bring the movement selection lever to neutral.
3. Remain seated in the driver's seat.
4. Turn the ignition key (fig. 150538-1) clockwise to position "1".
With the key in this position:
 - The control panel and instrument panel will be powered
 - A buzzer will sound, indicating that the key has been inserted. This buzzer also serves to warn any persons in the surrounding area that the vehicle has been started up.

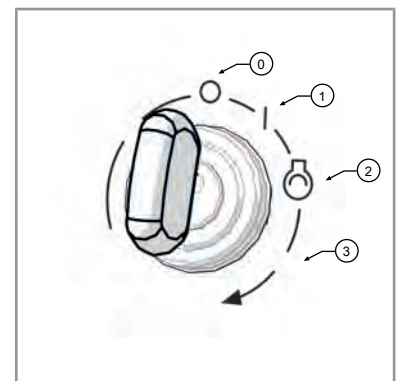

150538-1

- A check-up of the instrumentation will be performed with all the indicators lighting up for about 5 seconds. Only the following lights must remain switched on at the end of the check-up:
 - Engine oil pressure indicator light
 - Battery charge indicator light
 - General alarm warning light
 - Intermittent buzzer
 - Other indicators of activated functions (e.g.: Parking brake, gears engaged, etc.)

WARNING! If other indicators remain on signaling malfunctions or if one of the previous conditions does not occur, do NOT start-up the engine and refer to the "Maintenance" chapter or contact the Dieci service center.

1. Turn the ignition key (fig. 150538-1) to position "3" to start-up the engine. Release the starter within 5 seconds.
2. Release the key once the engine has started. The indicators related to the engine oil pressure and battery charge must go off once the engine is started up.
3. If the engine does not start within 5 seconds, try again at regular 15 second intervals to prevent overloading the starter.

5.16.4 Warm-up after starting-up

During the first few minutes of use, keep the speed slow in order to warm up the engine and hydraulic oil.



WARNING

Serious damage can be caused to the engine and the hydraulic system if the engine reaches high rpm before the operating oil temperature and pressure levels are reached.

Let the engine run at 1100 - 1300 rpm for about 5 minutes so as to bring the engine oil to the operating temperature, particularly, with outdoor temperatures below 0 °C.

5.16.5 Start-up at low environmental temperatures

Consider the following warnings before starting-up at low environmental temperatures and with a cold engine:

- In order to prevent discharging the battery, do not prolong each attempt to start-up by more than 15 seconds; however, if the engine does not seem to be starting-up, extend the time to a maximum of 30 seconds.
- Wait at least one minute before trying to start-up again.
- It is recommended to not exceed six start-up attempts so as not to discharge the battery excessively.



NOTICE

It is recommended to use anti-freeze diesel at environmental temperatures lower than 0°C, so as to make sure the engine is optimally supplied, without reducing performance.

5.16.6 Causes of failed start-ups

Check the following if the engine does not start-up:

- The parking brake switch is pressed.
- The gear selection lever is in the neutral position.
- No emergency buttons are pressed.

After checking all the previous conditions, remove the cause of failure to start and try the starting procedure again.



NOTICE

If the problem persists, contact a **Dieci** after-sales center.

5.16.7 Turn off the vehicle

It is recommended to perform the following before switching the engine off:

1. Bring all the control levers to the idle position.
2. Bring the engine to low speed for a few seconds.
3. Turn the ignition key to position "0".

6 Safety devices

6.1 Safety stickers

6.1.1 Warnings for safety stickers

Some safety stickers have been applied on the vehicle in the positions shown below. Their purpose is to provide a guide for your own and others safety. Before starting to work with the vehicle, check the content and location of the safety stickers turning around the vehicle with this manual in hand. Review the safety stickers with all operators who will use the vehicle.



CAUTION

Make sure to have fully understood their correct location and their contents.

To ensure proper interpretation verify that they are in the correct position and that they are always kept clean.



DANGER

Clean them when they are covered by mud, concrete or debris.

It is absolutely forbidden to clean the messages on the vehicle using solvents or gasoline; the stickers may become discolored. The stickers in addition to those of care and safety must always be treated in the same way.

See the summary table in the "Maintenance" chapter for the for safety stickers maintenance and control deadlines.

Replace the safety stickers in case of deterioration, damage or loss, as these must always be read and interpreted correctly.



WARNING

Do not under any circumstances remove the safety stickers.



































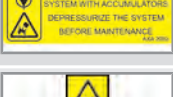

NOTICE



The purchase order of replacement safety stickers must be made in the same way in which any spare part is ordered (be sure to communicate the model and serial number of the vehicle when placing the order).

6.1.2 Meaning of safety stickers

SIGNAL	CODE	DESCRIPTION
	AXA1163	Warning, keep the boom fully retracted when digging with buckets.
	AXA1425	Danger, keep a safe distance when using the loading bucket
	AXA1425	Danger of crushing, use safety fasteners for maintenance

SIGNAL	CODE	DESCRIPTION
	AXA1425	Danger, keep a safe distance from the vehicle
	AXA1425	Danger, moving mechanical parts
	AXA1425	Danger, stop the engine before performing any maintenance
	AXA1425	Danger, stop the engine and remove the ignition key during maintenance operations
	AXA1425	Danger, comply with the safety distances from power lines
	AXA1427	Indicates where to refuel
	AXA1431	Indicates the lifting points
	AXA1432	Indicates the points at which to anchor the vehicle for transport or towing
	AXA1433	Indicates where to check the hydraulic oil level
	AXA1434	Indicates where refueling hydraulic oil
	AXA1435	Danger, moving mechanical parts, do not remove the safety guards and wait that the parts have stopped before carrying out any maintenance
	AXA1436	Indicates the position of the safety rod for lifting cylinders
	AXA1438	Indicates vehicle parts that can not be walked on
	AXA1439	Danger moving mechanical parts
	AXA1440	Danger of hot steam under pressure escaping
	AXA1441	Danger of hot surface
	AXA1492	Indicates the position of the brakes oil tank and the type of oil to use

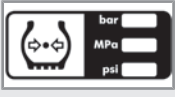
SIGNAL	CODE	DESCRIPTION
	AXA1493	Warning, keep a safe distance
	AXA1498	Indicates the position and instructions for using the battery cut-off switch
	AXA1501	Indicates greasing points
	AXA1506	Compulsory use of seat belts
	AXA1514	Emergency exit
	AXA1515	Remove split pin
	AXA1773	Warning, do not reach high speeds or over-revving the engine in downhill
	AXA2089	Caution, hydraulic circuit with pressure accumulators
	AXA2103	Warning, keep a safe distance
	AXA2430	Do not stand under the forks or transport people with the forks
	AXA2609	Instructions for joystick with capacitive deadman switch and continuous oil function
	AXA2610	Instructions for joystick with capacitive deadman switch and continuous oil function and FNR function
	AXA2613	Instructions for joystick with standard mechanical deadman switch
	AXA2614	Instructions for joystick with mechanical deadman switch and continuous oil function
	AXA2751	Instructions for joystick with mechanical deadman switch and continuous oil function and FNR function
	AXA1803	Instructions for joystick for standard man basket
	AXA2633	Instructions for joystick for man basket with continuous oil function

SIGNAL	CODE	DESCRIPTION
	AXA2708	Type of oil used in the hydraulic system.
SIGNAL	CODE	DESCRIPTION
	AXA1428	Indicates the tire pressure
	AXA1807	Indicates the maximum guaranteed sound power
	AXA2217	Tires maximum load on the ground (R.max daN=) 4000

6.1.3 Safety stickers position on the vehicle

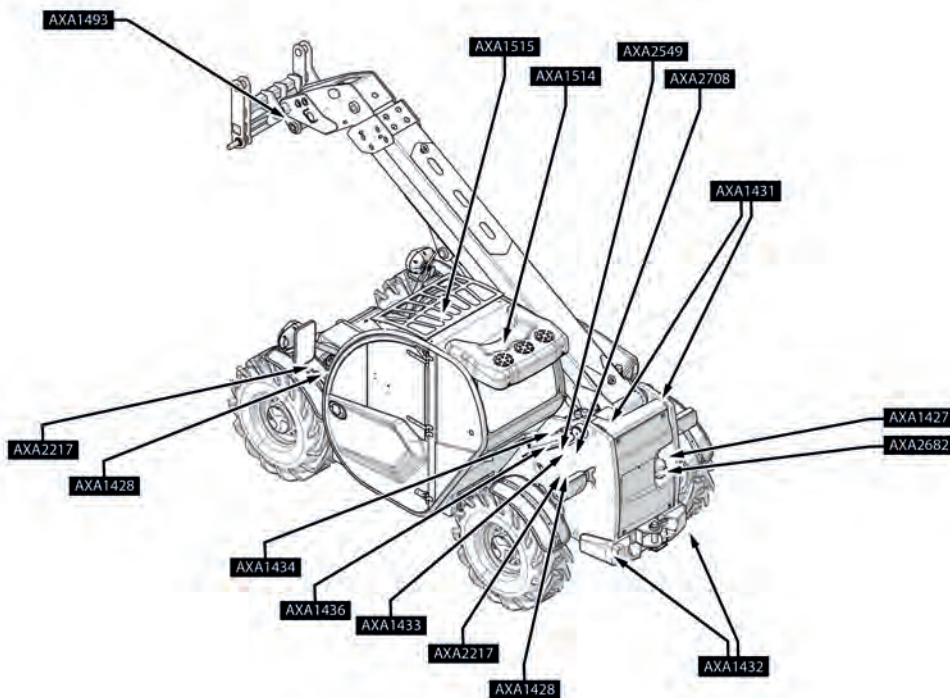
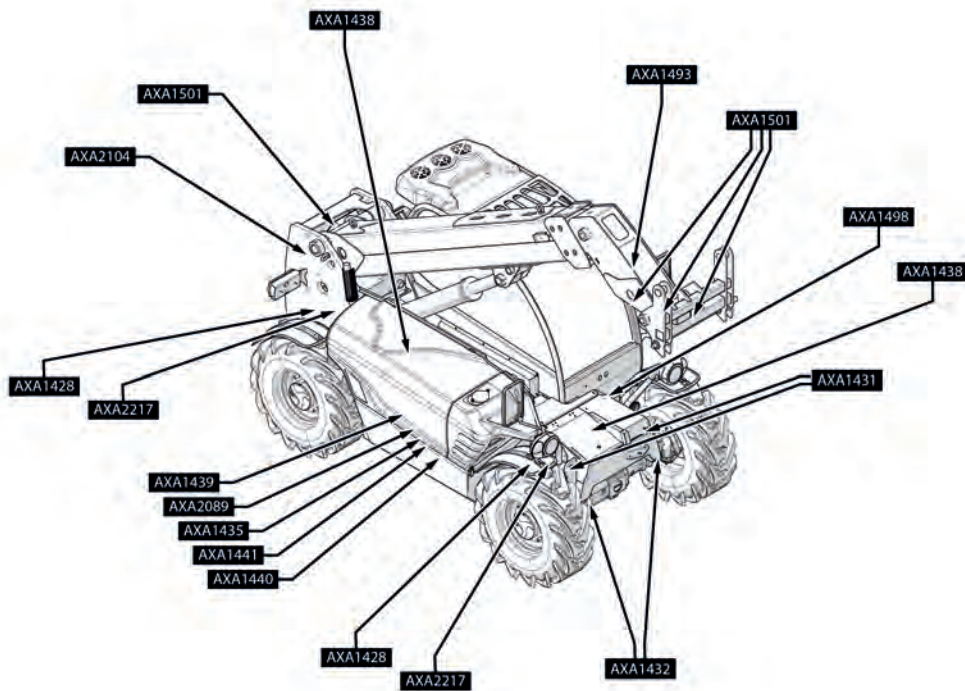

6.1.4 Safety stickers position in the cab

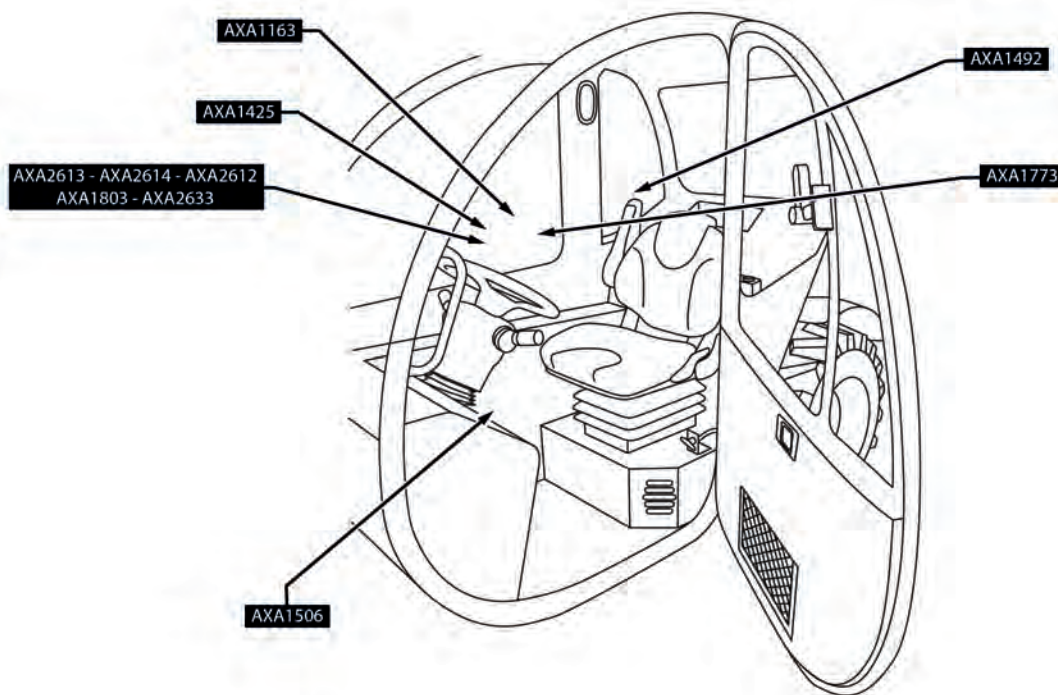

6.2 Reference to safety devices

Safety devices	Additional information
Safety devices	8.1.1 ROPS - FOPS Cab
	8.1.15 Emergency Lights
	8.1.16 Emergency stop
	8.1.17 Spirit Level
	8.1.18 Emergency exit: Rear glass
	8.2 Parking brake
	8.15 Safety rod
	8.16 Wheel wedge
	8.17 Block valves
	8.18 Diagrams notebook
	8.18.1 Capacity diagrams
	8.18.1.1 Read the capacity diagrams
	8.18.1.2 Use the capacity diagrams
	8.18.1.3 Equipment legend for capacity diagrams
	8.18.1.4 Operating modes legend for capacity diagrams

7 Vehicle description



NOTICE

The images used to describe components and controls refer to a complete vehicle with all accessories; these may vary depending on the model and on the configuration chosen.

Positions and references used in this manual refer to the machine facing the normal running direction.

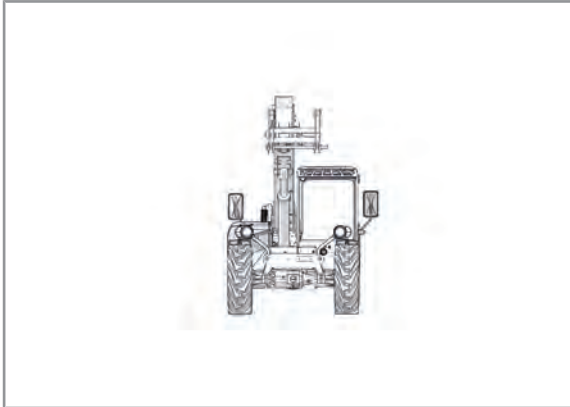

150641-1: Front view

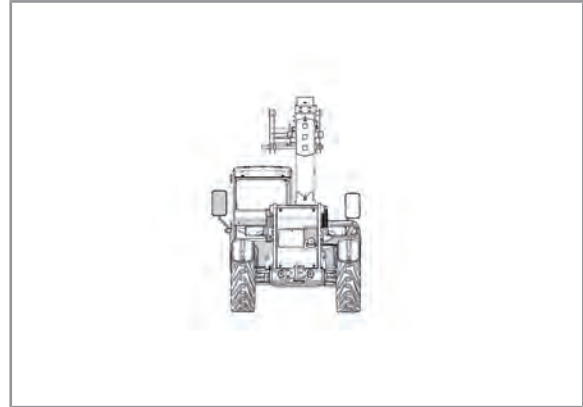

150641-2: Rear view



150641-3: Left view



150641-4: Right view

7.1 Left side description

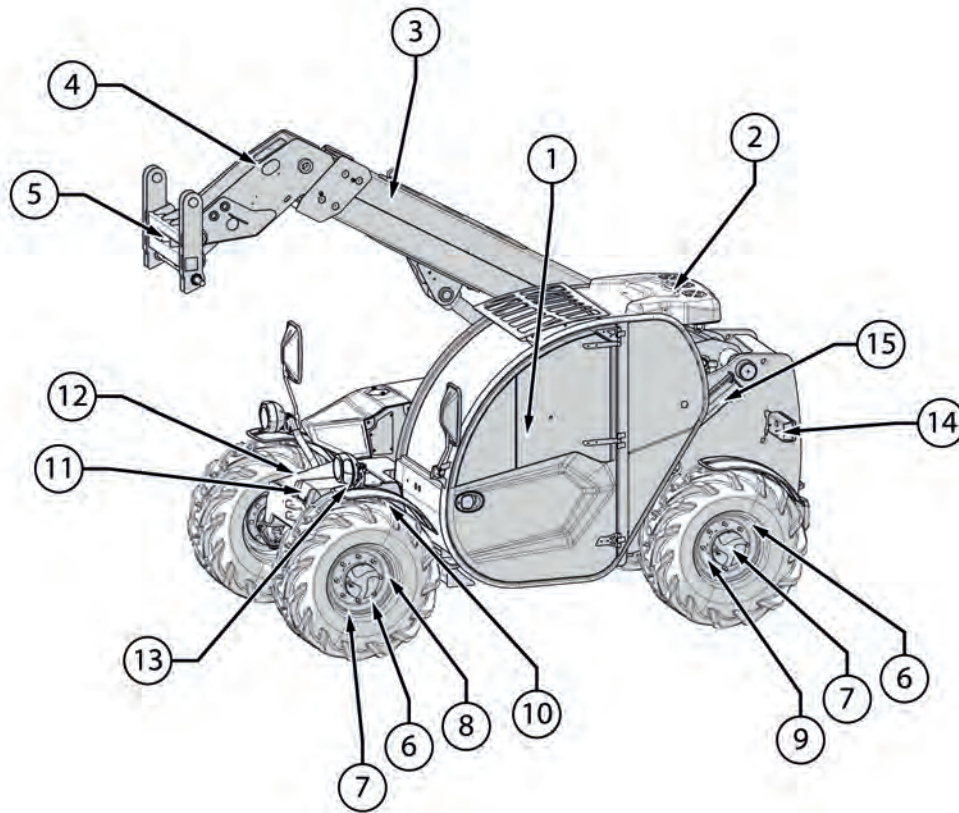

Illustration 1: 150986-1: Left side view

1 Cab	2 Air conditioned (optional)
3 Telescopic boom	4 Boom head
5 Tools holder plate	6 Epicycloidal reduction gear
7 Wheel	8 Front axle
9 Rear axle	10 Battery cut-off switch
11 Battery	12 External storage compartment
13 Left front headlight	14 Left rear headlight
15 Boom support rod	

7.2 Right side description

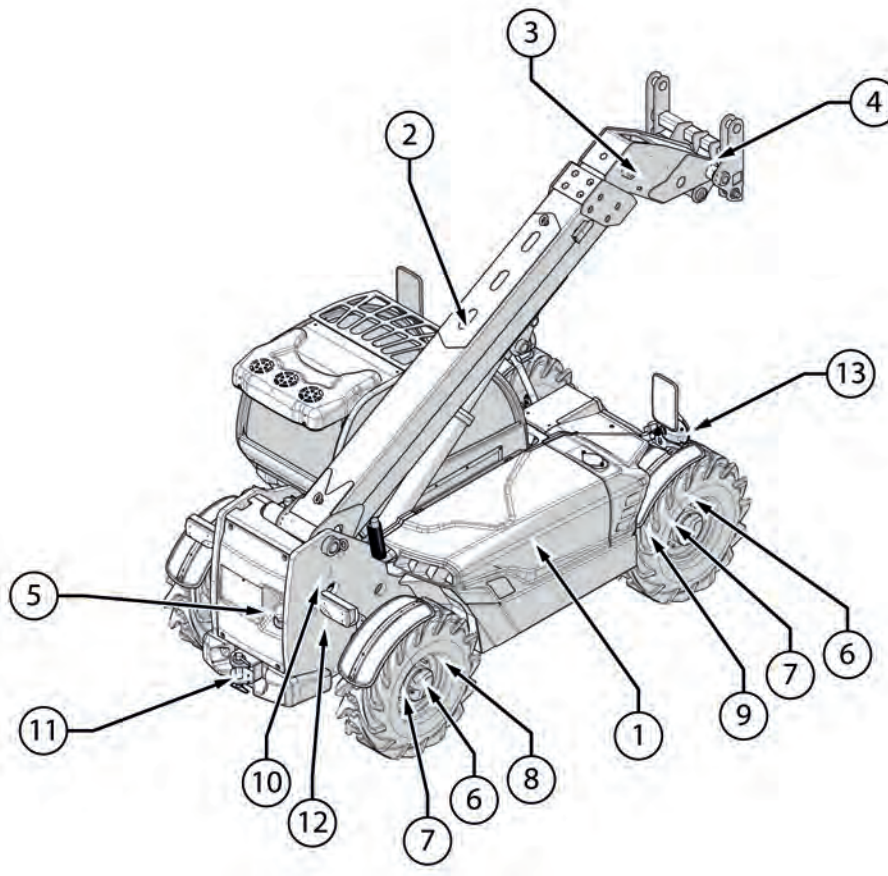

Illustration 2: 150988-1: Right side view

1 Engine hood	2 Telescopic boom
3 Boom head	4 Tools holder plate
5 Fuel filler cap	6 Epicycloidal reduction gear
7 Wheel	8 Rear axle
9 Front axle	10 Rear hydraulic sockets (Optional)
11 Tow hitch (Optional)	12 Right rear headlight
13 Right front headlight	

7.3 Engine description

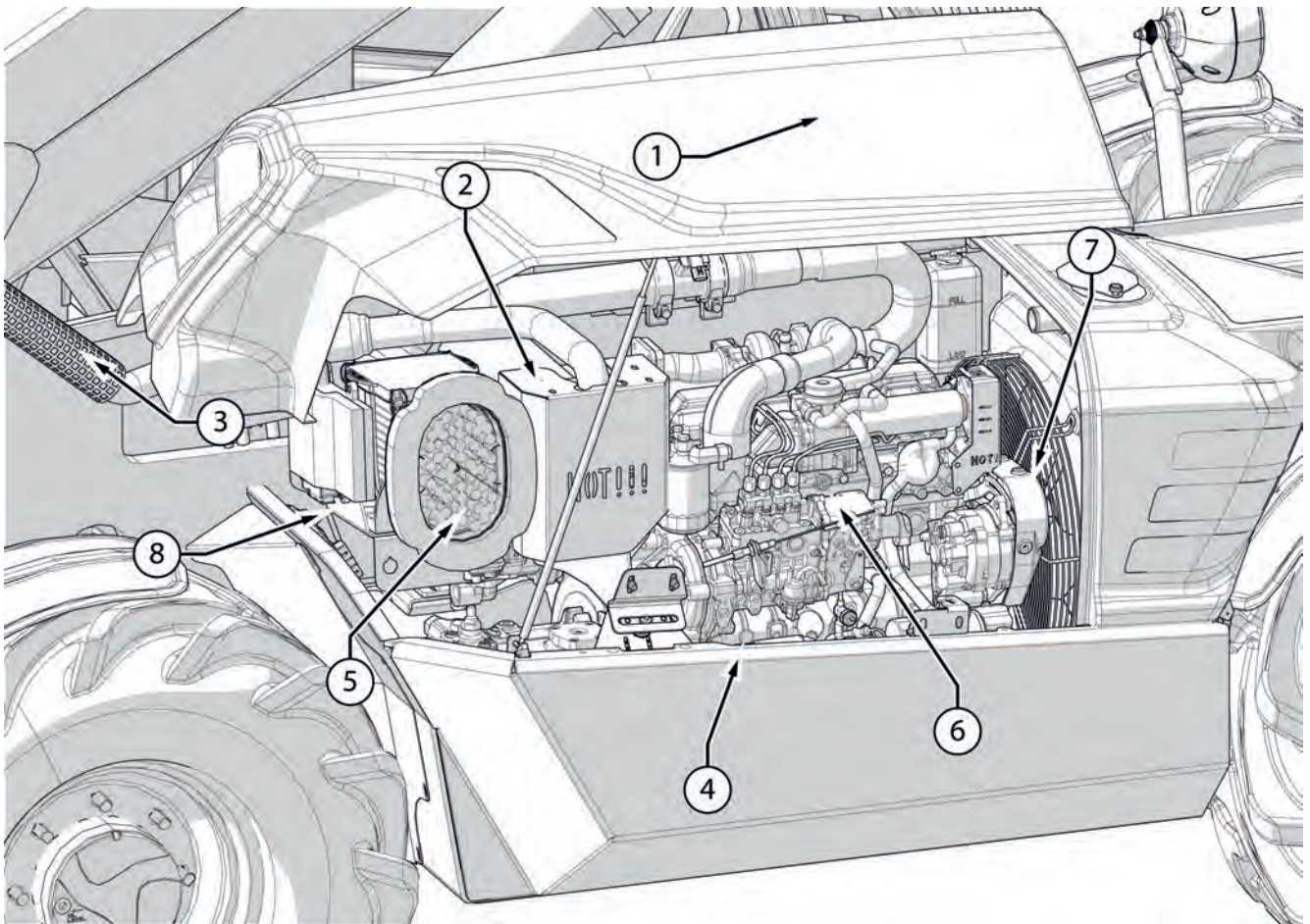

Illustration 3: 150984-1: Engine view

- | | |
|----------------|-----------------------|
| 1 Engine hood | 2 Muffler |
| 3 Exhaust pipe | 4 Support rod |
| 5 Air filter | 6 Engine |
| 7 Radiator | 8 Engine control unit |

7.4 Cab description

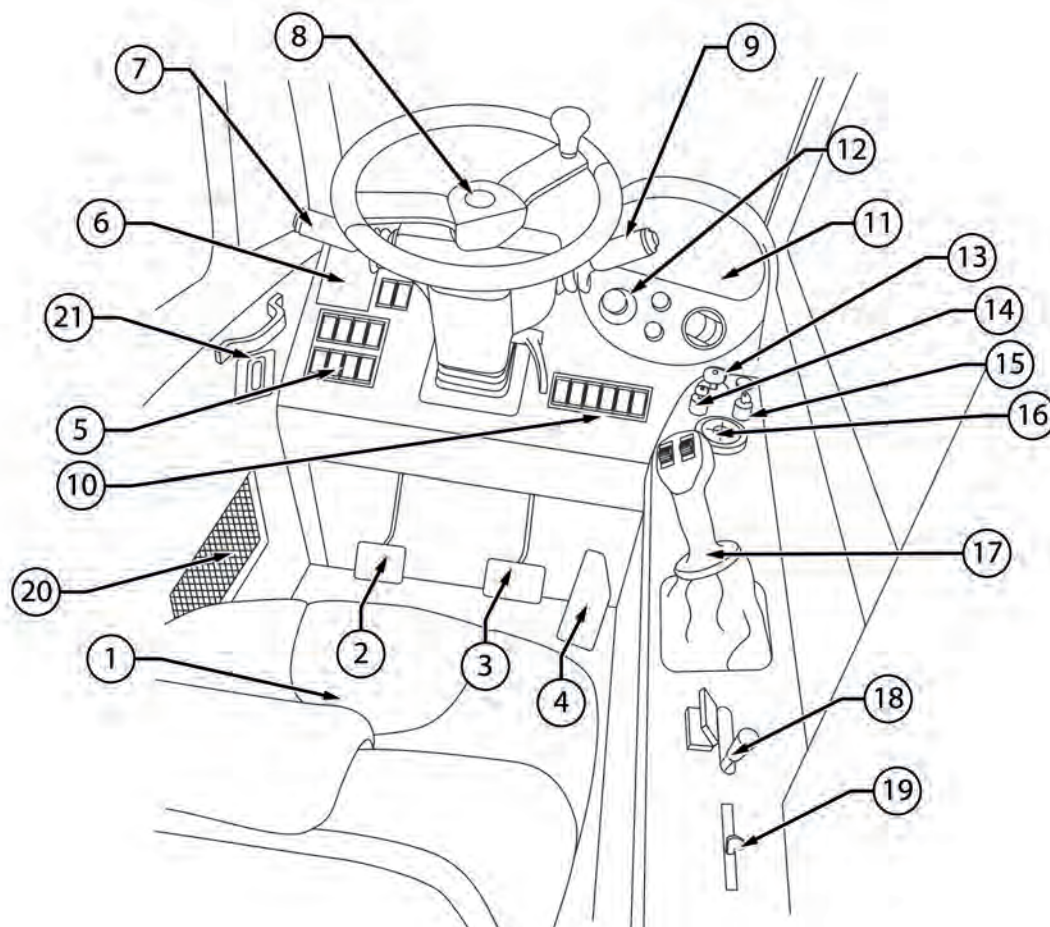

Illustration 4: 150989: Components inside the cab

1 Seat	2 Inching Pedal
3 Brake pedal	4 Accelerator pedal
5 Left instrument panel	6 Diagrams notebook
7 Movement selection lever	8 Steering wheel
9 Window wipers and direction indicators lever	10 Right instrument panel
11 Instrument panel	12 Emergency stop button
13 Ignition key	14 ByPass key
15 Equipment selection key	16 Spirit Level
17 Joystick	18 Steering selection lever
19 Heating lever	20 Document holder net
21 Door opening handle	

8 Components description

8.1 Cab

8.1.1 ROPS - FOPS Cab

The vehicle is equipped with an approved cab:

- **ROPS** (Roll Over Protection Structure)
- **FOPS** (Falling Objects Protective Structure)

The operator is therefore protected in the event of vehicle tipping and in the event of falling objects, as prescribed for earth moving vehicles.

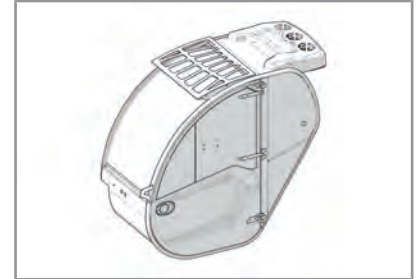

150990-1



CAUTION

The cab is a safety device and as such must be always kept in the right conditions of use.

In case of cab tampering, the manufacturer has no civil liability in case of an accident, therefore it is absolutely forbidden to:

- Change, drill, or alter in any way the structure of the cab.
- Weld or mechanically connect parts to the cab chassis.
- If the fastening bolts are replaced, use elements of different strength class.
- Connect chains or ropes to the cab for the purpose of towing.



WARNING

In the case of vehicle tipping, staying in the cab with fastened seat belts allows to obtain a better protection.

If the cab has undergone visual damage it must be replaced by consulting the authorized service center or Dieci authorized workshop.

The cab is classified as: CATEGORY "1"

The cab approved as category "1" does not offer full protection against the ingress of dust, aerosols and vapors. Consult and follow the instructions provided by the manufacturer of the chemicals used (such as pesticides, fungicides, herbicides, etc..) and those supplied by the manufacturer of the sprayer. Use the appropriate personal protective equipment and clothing (PPE) when indicated in these instructions, even when you are inside the cab.



DANGER

Inhalation danger for operators and bystanders.

For protection against harmful dust, aerosols and vapors, refer to the instructions provided by the manufacturer of chemicals, by the manufacturer of the sprayer and to the basic rules contained in this manual.

Refer to the packaging of the product used to use the appropriate protective equipment.

8.1.2 Door opening

8.1.2.1 External door handle

The door of the cab is equipped with an external handle "1" (fig. 150901-1) with lock.

To open the door from the outside:

1. Insert the key into the lock and turn it clockwise/ counterclockwise to engage/disengage the lock.
2. Pull the handle towards yourself to release the door with lock disengaged.

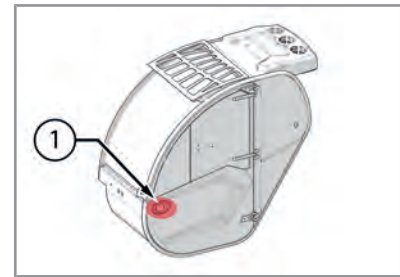

150901-1



NOTICE

With lock engaged, the door will not open by the handle.



WARNING

It is absolutely forbidden to operate with the cab door open.

8.1.2.2 Internal door handle

To open the door from the inside (fig. 150901-2):

1. Pull the handle towards you to disengage the door "1".
2. Push the door to the outside to complete the opening.
3. Accompany the door with one hand while opening it.

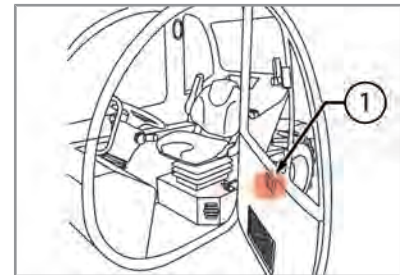

150901-2



CAUTION

Before pushing the door outwards verify that the opening area is free from obstacles of various kinds.

8.1.3 Climbing in/out



NOTICE

Before climbing into the cab, make sure your hands and your shoes are clean and dry to avoid slipping and falling.

Use only the appropriate handles and steps to access the cab, do not use the controls and the steering wheel from inside. Climb in and out of the vehicle always turned towards the driver's cab.

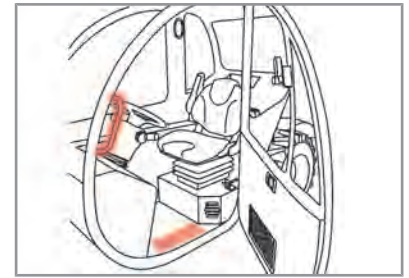

150902-1



WARNING

RISKS

Climbing in and out of the cab is allowed only when the vehicle is stopped with the parking brake engaged. Do not leave the cab with the vehicle in motion.

8.1.4 Door glass

To open the door glass (fig. 150903-1):

- Lower the handle "1" turning it counterclockwise and pushing the glass outward.
- To stop the glass in the open position, push the glass until it fits into the block "2".

To close the door glass it is necessary to:

- Turn the block "2" to unlock the glass and close it.
- To close the glass pull it towards yourself to the starting position.
- Rotate the handle "1" in clockwise direction to lock the glass in the closed position.

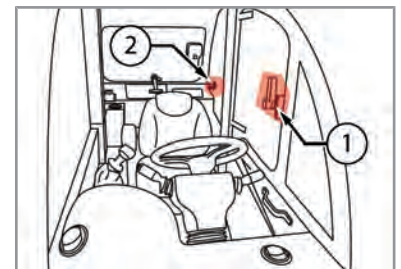

150903-1



CAUTION

Before opening or closing the glass make sure that the surrounding area is free from obstacles of various kinds.

Before starting to working make sure that the glass of the door is locked, whether it is in the open or closed position.

8.1.5 Rear glass

To open the rear glass, lift the handle "1" (fig. 150904-1) and push the glass outward.

The glass is maintained in the open position by the handle.

To close the rear glass, pull the handle back in the cab and lower until it until the whole unit is completely locked.

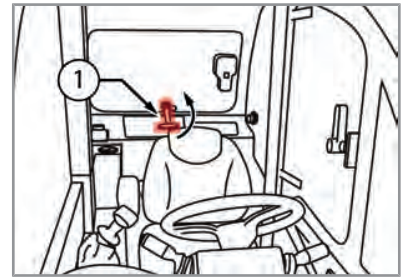

150904-1



WARNING

Danger of crushing

In case the handle would no longer maintain the open position of the glass, replace it in the shortest possible time.



NOTICE

The rear glass also serves as an emergency exit, see the "Safety Devices" chapter for more information.

8.1.6 Sunshade

The Sunshade is located at the top of the cab (fig. 150996-1).

To lower the Sunshade, take the handle located at the center of "1" and lower it down to lock it the hooks provided "2".

To close the sunshade, lower the handle "1" to release it from the hooks "2" and take back the sunshade in closure.

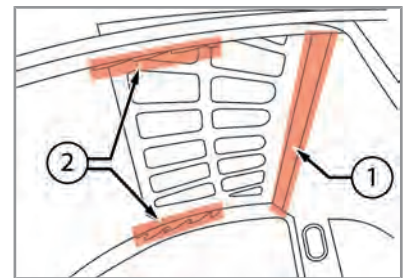

150996-1

8.1.7 Cab ventilation

8.1.7.1 Ventilation adjustment

To adjust the ventilation press the switch "1" (fig. 150990-1).

Clicks indicate respectively:

0 - Off

1 - First speed

2 - Second speed

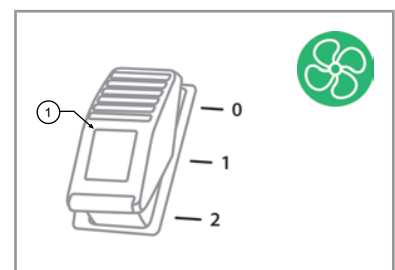

150990-1

8.1.7.2 Air temperature adjustment

To adjust the temperature of air coming out of the vents, move the lever "1" located in the right side of the Cab (fig. 150991-1):

- Move the lever forward (in the red scale) to increase the temperature.
- Move the lever backward (in the blue scale) to decrease the temperature until it is next to the outside temperature.

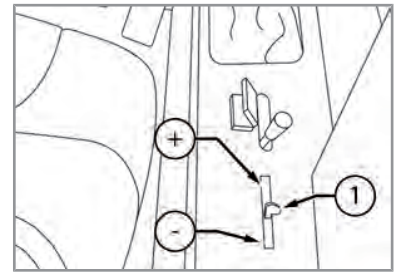

150991-1

8.1.7.3 Air vents

To open the air vents press on one side of these and adjust the air flow direction using the fins or rotating the vent.

To close the vents push the fins bringing them to the horizontal closing position.

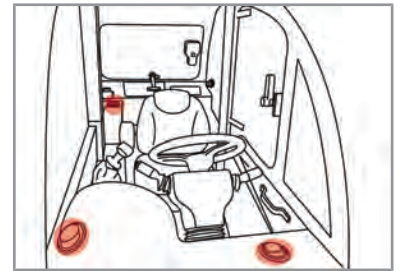

150992-1

8.1.8 Air conditioning *



NOTICE

* Air conditioning is an optional accessory.

For a correct use of air conditioning, follow the following steps:

1. Check that all doors and windows are closed.
2. Check that the heater is turned off by moving the lever "1" (fig. 150995-3) towards the end of the blue scale.
3. With the engine running, turn on the air conditioning pressing the switch "1" (fig. 150995-2). The illuminated warning light on the switch indicates that the air conditioning is on.
4. Press switch "1" (fig. 150995-1) to adjust the ventilation intensity.
5. Open and adjust the vents to obtain the best cooling according to the ambient temperature.
6. Turn the temperature lever 1 (fig. 150995-3) to obtain the desired temperature.

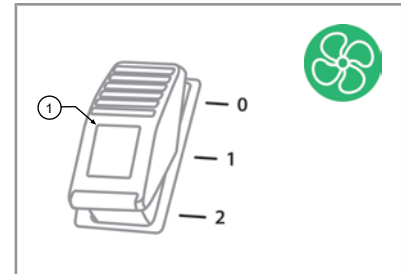

150995-1

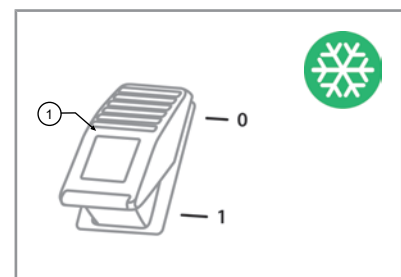

150995-2

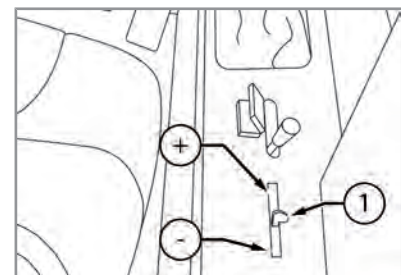

150995-3



CAUTION

Turn on the air conditioning two minutes, every 15 days, even in the colder seasons with the engine idling (without accelerating). In this way the moving parts, such as the compressor and the system in general are lubricated.

To keep the air conditioning system efficient keep the condenser clean.



DANGER

Do not loosen any hose of air conditioning systems in order to reach the capacitor since the contact between the skin and the refrigerant can cause frostbite.

For maintenance and deadlines, see the "Maintenance" chapter.

8.1.9 Cab lighting

To turn on the lighting inside the cab act on the ceiling light pressing one of the ends "1" (fig. 150906-1).

In the center position the lighting is turned off.

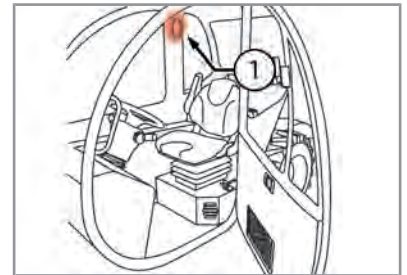

150906-1

8.1.10 12V Socket

The 12V-180W socket "1" (fig. 150908-1) allows to connect direct current devices (battery chargers, cell phones, etc.)

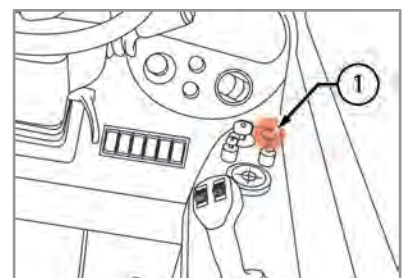

150908-1



WARNING

Do not connect users with nominal voltage greater than 12V and power consumption greater than 180W.

Risk of damage to the electrical system.

8.1.11 Steering wheel

The steering wheel of the machine allows steering the machine wheels according to the steering mode set.



NOTICE

Refer to the "Steering selector" chapter.

8.1.11.1 Steering wheel adjustment

To adjust the steering wheel angle (fig. 150401-1):

1. Turn the steering wheel adjustment lever "1" (fig. 150401-2) down to unlock the movements.
2. Push the steering wheel forward or pull it towards yourself to the desired position.
3. Push down or pull up on the steering wheel to the desired height.
4. Turn the steering wheel adjustment lever up to lock the steering wheel in the position in which it is located. For correct locking, screw firmly.

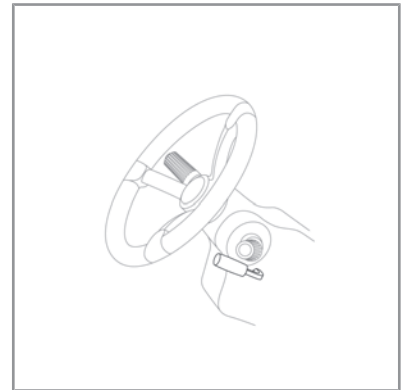

150401-1

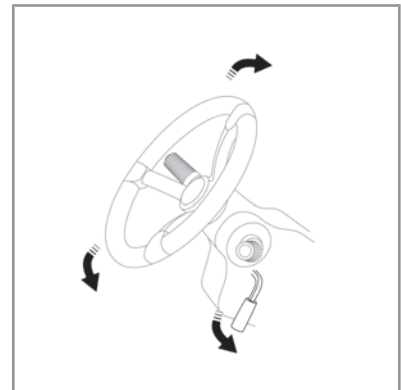

150401-2



NOTICE

The steering wheel is properly adjusted when the operator, with the back firmly against the backrest of the seat, is able to grasp the furthest side of the steering wheel while keeping the elbow slightly bent.

8.1.12 Multifunction lever

The multifunction lever contains several functions: direction indicators, horn, headlights turning on, window wipers and washers.

8.1.12.1 Direction indicators

Move the lever (fig. 150402-1):

- Towards yourself to indicate a curve to the right (**R**).
- Forward to indicate a curve to the left (**L**).

The indicators only work when the ignition switch is in the position of instrumentation on.

The indicator light "1" on the central instrument panel will activate the direction indicators.

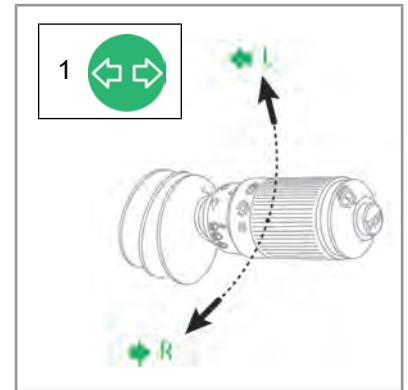

150402-1



CAUTION

Push the multifunction lever in stand-by position after making the turn, return to the neutral position is not automatic.

8.1.12.2 Horn

Press the button on the end of the lever "1" (fig. 150403-1), to activate the horn.

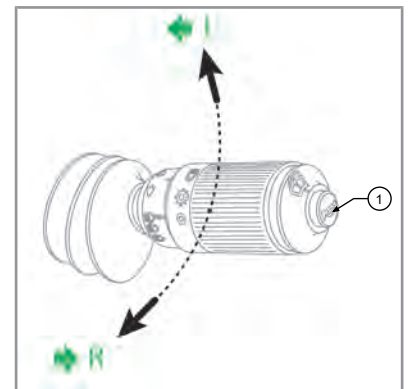

150403-1

8.1.12.3 Front window wiper

Press the switch "1" (fig. 150404-1) in intermediate position "1" to activate the front window wiper. To turn off the front window wiper return the switch "1" in position "0".

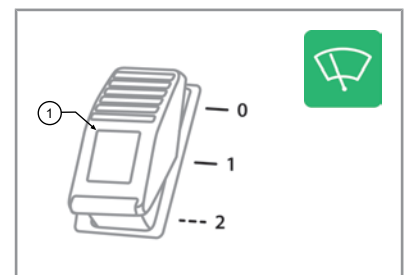

150404-1



WARNING

Worn blades cause viewing difficulties and scratches to the glass.

Replace the blades if they are damaged or worn.

8.1.12.4 Window washer

Press the button "1" (fig. 150405-1) in position "2", to activate the front window washer.

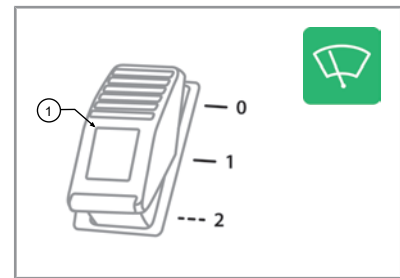

150405-1

8.1.12.5 Rear window wiper and washer

Press the button "1" (fig. 150406-1), to activate the rear window washer.

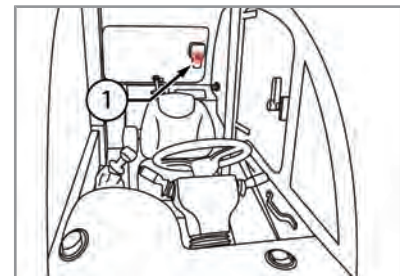

150406-1

Press the intermediate button "1" (fig. 150406-2) on the multifunction lever to activate the rear window washer.

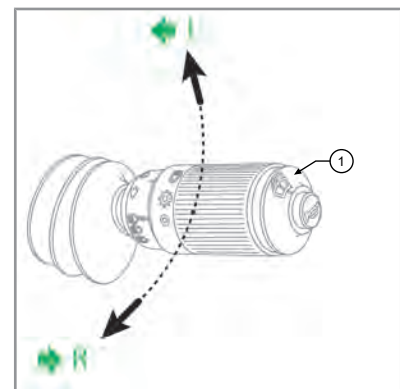

150406-2

8.1.13 Lights turning on

8.1.13.1 Sidelights and low beam lights

To turn on the front and rear sidelights of the vehicle, turn the multifunction lever (fig. 150407-1).

The lever has 3 stable positions:

- 0- Lights off
- 1- Side lights on
- 2 - Low beam lights on

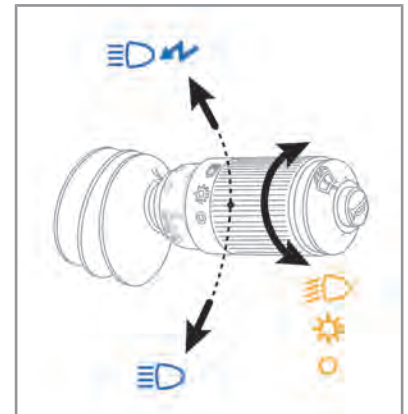

150407-1

When the low beam lights are activated the instrument panel of the vehicle lights on.



NOTICE

It is possible to turn on the sidelights with the ignition key in "0" position, while it is necessary to bring the ignition key in position "I" to turn on the low beam lights.

8.1.13.2 High beam lights

To turn on the high beam lights it is necessary to move the multifunction lever (fig. 150408-1).

- To make individual flashes with the high beam lights, pull the multifunction lever toward the steering wheel. It is possible to use this function with the lights off and the ignition key in position "0".
- To turn on the high beam lights, push the multifunction lever downwards. It is possible to turn on the high beam lights only with the ignition key in position "I" and low beam lights on. The high beam lights turned on is indicated by the warning light "1" on the instrument panel.

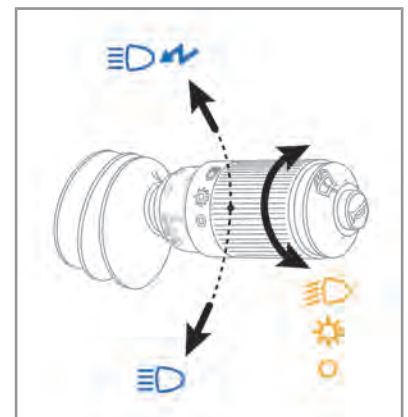

150408-1

8.1.13.3 Cab front light *



NOTICE

* The cab front light is an optional accessory.

Press the switch "1" (fig. 150409-1) located on the canopy instrument panel to turn on the front work light.

The warning light on the same switch indicates that the light is turned on.

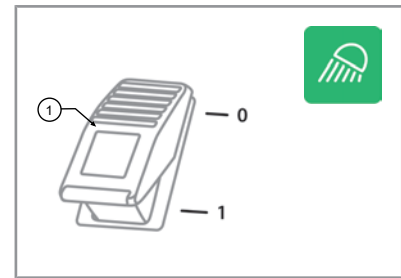

150409-1



NOTICE

To turn on the headlight it is necessary to bring the ignition key in position "I".

8.1.13.4 Cab rear light *



NOTICE

* The cab rear light is an optional accessory.

Press the switch "1" (fig. 150410-1) located on the canopy instrument panel to turn on the rear work light.

The warning light on the same switch indicates that the light is turned on.

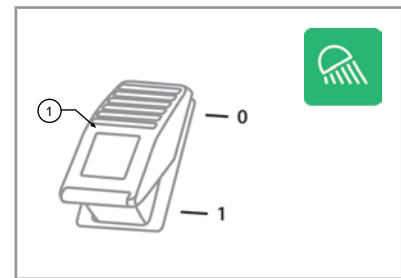

150410-1



NOTICE

To turn on the headlight it is necessary to bring the ignition key in position "I".

8.1.13.5 Work light on the boom head*



NOTICE

* The work light on the boom head is an optional accessory.

Press the switch "1" (fig. 150411-1) located on the canopy instrument panel, to turn on the work light on the boom head.

The warning light on the same switch indicates that the light is turned on.

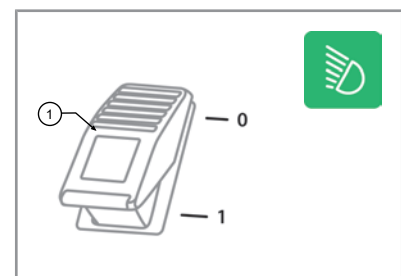

150411-1



NOTICE

To turn on the headlight it is necessary to bring the ignition key in position "I".

8.1.13.6 Rotating light

The rotating light "1" (fig 150412-1) must be placed above the driver's cab and must always be in operation both on site and during road use.

To activate and position the rotating light, perform the following steps:

1. Clean and dry the top of the driver's cab.
2. Place the rotating light on the cab.
3. Insert the plug of the rotating light into the socket on the rear left side of the cab, under the rear window.
4. Turn on the rotating light using the switch on the canopy instrument panel.

The rotating light turned on is indicated by the indicator light on the switch.

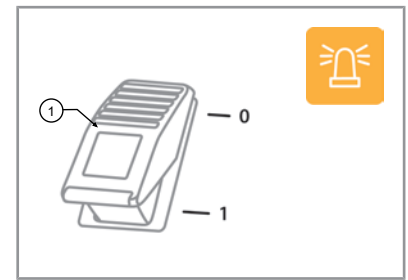

150412-1



NOTICE

It is possible to turn on the rotating light even if the ignition key is in the "0" position.



WARNING

Risk of damage to the electrical system.

Do not connect users with nominal voltage greater than 12V and power consumption greater than 180W.

8.1.14 Seat

8.1.14.1 Deadman seat sensor

The vehicle is equipped with a safety system called "deadman" which consists of an electrical microswitch inside the seat cushion "1" (fig. 150413-1).

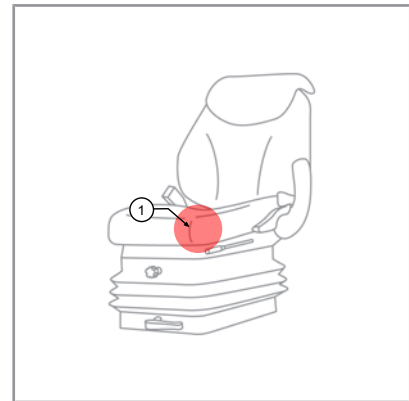

150413-1



CAUTION

The engine can be started only if the operator is seated properly in the driving seat and the gear lever is in neutral "N".

If the engine is running and the operator is not sitting properly in the driver's seat for a time longer than **3 seconds**, the transmission is automatically disabled and the park brake is engaged.

To continue moving the machine, the operator must sit in the driver's seat and set the movement selection lever in position "N".

8.1.14.2 Seat adjustment



CAUTION

Correctly position the seat.

The seat is properly positioned when the operator is able to perform a full stroke to the brake pedal by holding the back against the backrest of the seat itself.

The seat can be adjusted to different positions:

Backrest inclination

To adjust the inclination of the backrest (fig. 150415-1), lift the lever on the left side and let the backrest adapt to the required position. Release the lever to block the backrest.



150415-1

Backrest height

To adjust the backrest height (fig. 150415-2), lift or lower the top of the backrest.

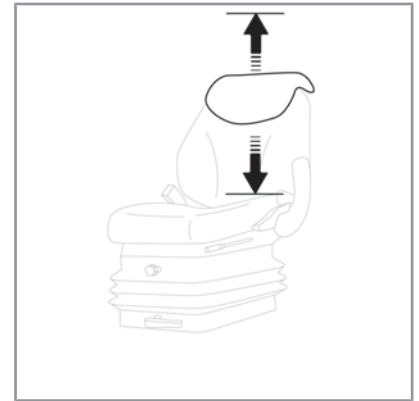

150415-2

Horizontal position

To adjust the seat longitudinally (fig. 150415-3), move the lever to the left and slide the seat along the guides. Once established the desired position, release the lever. Perform small movements to make sure that the seat is fastened properly.



150415-3

Horizontal suspension

To unlock the horizontal suspension (fig. 150415-4), move the lever forward; to lock the suspension move the lever backward.

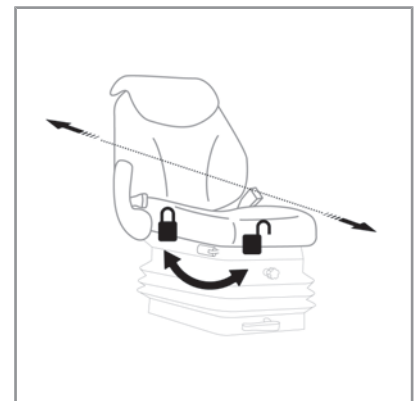

150415-4

Vertical position

To adjust the seat height (fig. 150415-5), turn the lever to the symbol "+" to increase the height or to the symbol "-" to reduce the height.

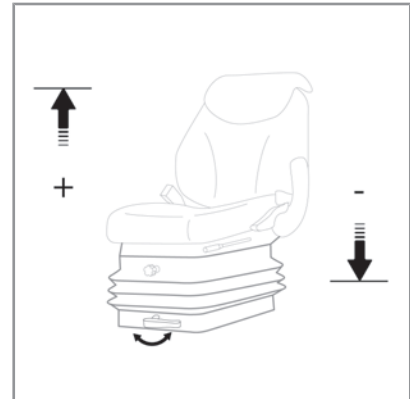

150415-5

Mechanical suspension degree

To adjust the degree of suspension (fig. 150415-6) turn the knob towards "+" to soften the suspension. Turn the knob towards the "-" to hardened suspension.



150415-6

Pneumatic suspension degree *



NOTICE

The pneumatic suspension of the seat is an optional accessory.

To adjust the pneumatic spring rate, pull knob (fig. 150415-7) to let out pressure and soften suspension. Push the knob to add pressure and harden suspension.

Pneumatic adjustment can only be performed with the engine running.



150415-7

8.1.14.3 Seat belts



WARNING

Always fasten the seat belts when operating the machine.

The machine is equipped with a cab that can withstand the weight of the machine in the event of rollover (ROPS), it is therefore necessary that the operator remains tied to the seat by the seat belt not to be swept out and possibly crushed.

Before starting the vehicle, carefully examine the straps, buckles and fastening devices to the structure. If some component is damaged or worn, replace the seat belt or the component before operating the vehicle.

Remain seated with the seat belts fastened properly for all the time of operation of the vehicle to reduce the risk of injury in case of accident.

Following an accident of a certain importance, replace the seat belts, even if they do not appear damaged.

To fasten the seat belt is necessary to:

1. Insert the latch plate "1" in the buckle "2".
1. Make sure of that the hooking occurred, and then adjust the belt around the body.
2. The belt is considered properly connected when it is close to the body

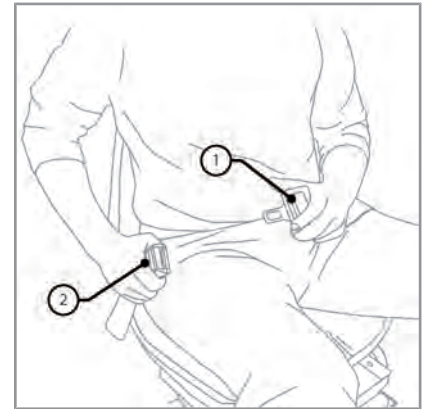

150416-1

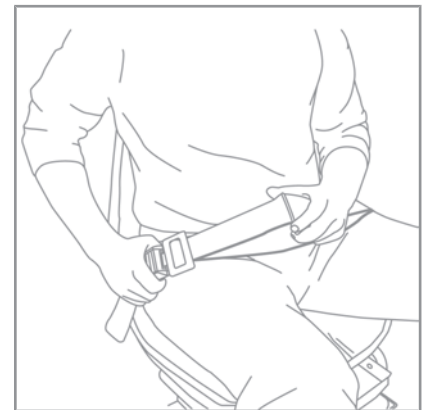

150416-2

To remove the belt it is necessary to:

1. Press the red button "1" on the buckle "2".
2. Then remove the latch plate "3".

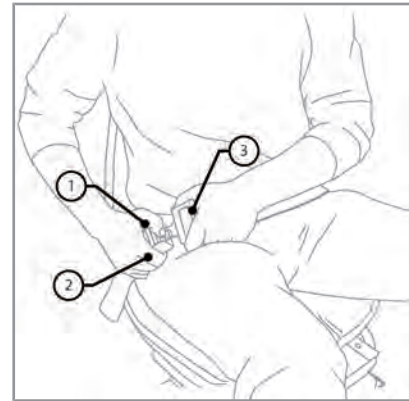

150416-3



WARNING

Drive the vehicle only with safety belt properly worn, fastened and adjusted.

Operating without the seat belt fastened increases the risk of accidents.

Do not use damaged or worn seat belts. If worn, damaged or yielded belts are used, they can break or yield in case of collision resulting in serious injury to the operator.

8.1.15 Emergency Lights

Press the emergency lights switch "1" (fig. 150419-1) to turn on all four direction indicators.

The sidelights turning on is indicated by the switch flashing and by indicator "2" on the instrument panel of the machine.

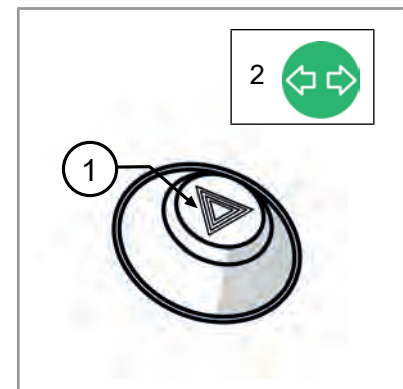

150419-1

8.1.16 Emergency stop

In emergency conditions, the machine can be stopped using the Emergency stop button in the cab (fig. 150420-1); the stop occurs immediately.



150420-1



CAUTION

It is recommended to use the emergency stop button only in case that there is an immediate danger to the operator, to the load and/or to the integrity of the machine.

The pressure exerted on the emergency stop button activates the power supply cu-off and the consequent complete shutdown of the machine and any connected equipment.

The return to normal working conditions, after a stop caused by the emergency stop button, is only possible after:

- Removal of the cause that caused the stop
- Releasing the emergency stop button

To release the emergency stop button, rotate it in the direction indicated by the arrow printed on the button.

8.1.17 Spirit Level

The spirit level is located in the center of the instrument panel. It is used to verify the correct transverse leveling of the vehicle.

To safely operate the spirit level must in the center, with a maximum approximation of 2° to the right or left.

In the standard spirit level, the angle exceeds 2° when the spirit level moves completely outside the 2 limit marks of 2°.



150421-1



DANGER

DANGER OF TRANSVERSE TIPPING.

To safely operate the spirit level must in the center, with a maximum approximation of 2° to the right or left.

8.1.18 Emergency exit: Rear glass

The rear glass of the cab (fig. 150422-1) can be used as an emergency exit in case the vehicle doors are locked.

To open the window fully, slide the fastener to "1" and push the glass outward.

The fastener must always be positioned as shown in the figure during normal work operations.

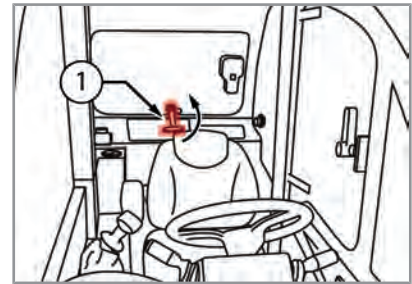

150422-1



DANGER

Danger of crushing.

It is prohibited to fully open the glass during the use of the vehicle, because of the shearing risks between the boom and the chassis.

The rear glass is near the telescopic boom.



WARNING

Be very careful when opening and/or removing the glass, as this may chip or crush and may cause injury to the operator in the cab and to who is near the vehicle.

8.1.19 Cab front glass protection *



NOTICE

*** The cab front protection glass is an optional accessory.**

Consult your dealer in case of doubts or information on your vehicle.

It is not possible to install the cab front protection glass in case the vehicle is provided with front emergency exit.

The cab front protection glass (fig. 150424-1) provides a higher protection level against any large/heavy loads or objects, which may fall on the cab.

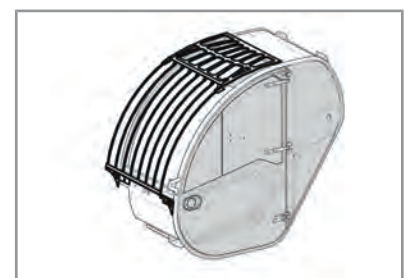

150424-1



CAUTION

If the vehicle is equipped with the front glass protection, it is not permitted to ride on public roads, except for the exceptions permitted by the regulations in force in the country of use.

8.1.20 Warnings in case of vehicle tipping

- The seat belt is the best guarantee of protection for you in case of lateral or front tipping of the vehicle
- Stay calm: stay on board, do not try to jump out of the driver's seat

- Hold the steering wheel with both hands
- Push your feet strongly on the floor, keeping them within the driver's seat
- Tilt your body in the opposite direction to that of the fall
- To avoid head impact, move your head as much as possible towards the steering wheel

8.2 Parking brake

To engage the parking brake, press the switch to "1" (fig. 150454-1).

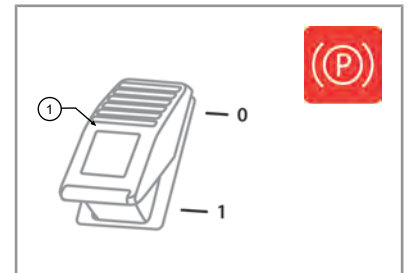

150454-1

The parking brake properly engaged is indicated by the lighting of the switch and the warning light on the instrument panel of the vehicle (fig. 150454-2).

With the parking brake engaged, the machine cannot move; the hydrostatic transmission is switched off and the wheels are braked.



150454-2



150454-3

The parking brake must be engaged:

- Every time the operator leave the machine, even in case of momentary stop
- Whenever the machine operates from a standstill even with outriggers down (if any)

The brake engages automatically when the engine is stopped.



WARNING

Unauthorized modification of axle ratios, the weight of the machine, the size of the wheels and tires can affect the efficiency of the parking brake.



NOTICE

To verify the efficiency of the parking brake contact a **DIECI** authorized workshop.



DANGER

RISKS: In case of failure of the parking brake do not use the vehicle.

If the warning light (fig. 150454-3) turns on intermittently, it indicates a low brake fluid level.

If the warning light (fig. 150454-3) turns on in a fixed way, the parking brake is stuck or damaged.

Do not use the vehicle until the problem has been solved. Contact a **Dieci** service center.

8.2.1 Braking circuit errors list



NOTICE

In case the machine is in error, contact a **Dieci** service center to solve the problem, indicating the error code reported.

For more information about the errors display, refer to the "Central instrument panel" chapter.

Icon	Example	Description
	00000000	Parking brakes errors or brakes failure

Code	Description
100	Service brakes low oil level reporting
101	Parching brake system failure
102	Parking brake accumulator low pressure

8.2.2 Deactivating the parking brake manually

The parking brake must be disengaged directly on the front axle with the engine off to allow the vehicle to be towed:

- Place safety wedges under the wheels to prevent the vehicle from moving suddenly.
- Unscrew the lower protection casing (if present).
- Loosen the bolts on both sides "A" and "B" (fig. 150560-1) of the central body of the front axle using a **24** spanner.
- Loosen the bolts just enough to be able to slip off the "U-shaped" shims (fig. 150560-2 and 150560-3).
- Tighten the previously loosen bolts all the way down.

In these conditions it is possible to tow the vehicle.

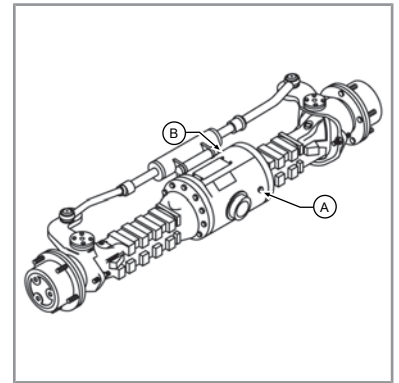

150560-1

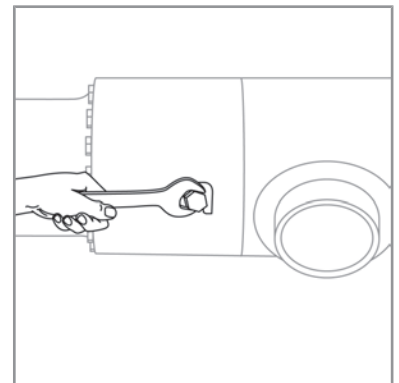

150560-2

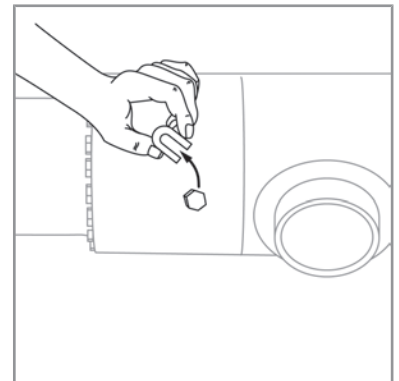

150560-3



DANGER

Never use the vehicle with the negative parking brake disengaged/disconnected.

To return the brake to working condition, return in to its original conditions.

8.3 Matrix EVO instrument panel

8.3.1 Components

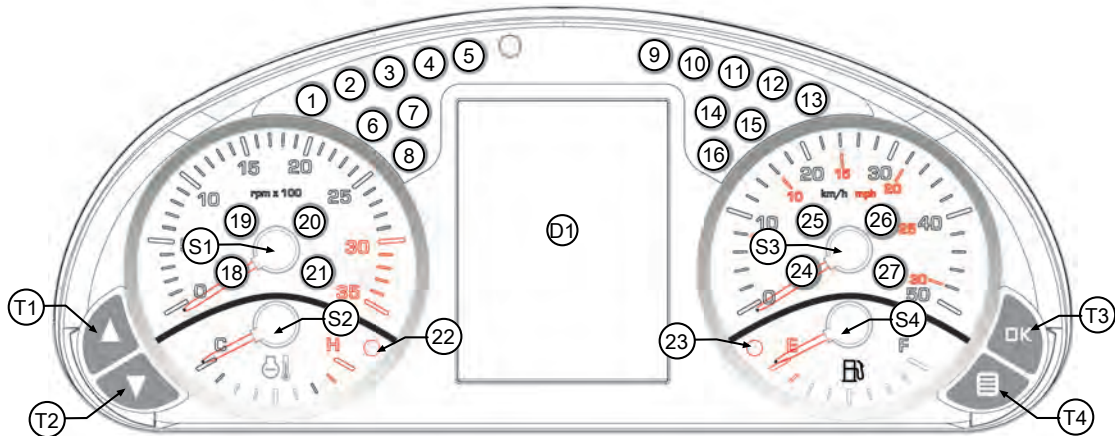















Illustration 5: 150425-1 - Instrument panel components

Position	Indicator light			Description
T1	-	-	-	UP button
T2	-	-	-	DOWN button
T3	-	-	-	OK button
T4	-	-	-	MENU key
D1	-	-	-	Display
S1	-	-	-	Tachometer indicator
S2	-	-	-	Engine water temperature indicator
S3	-	-	-	Speed indicator
S4	-	-	-	Fuel level indicator
1		Red	Fixed	Generator, battery failure
2		Red	Fixed	Engine oil low pressure
3		Yellow	Fixed	Glow plugs
4		Red	Fixed	Parking brake insufficient pressure
5		Red	Fixed	Engine air filter clogging
6		Red	Fixed	Hydrostatic oil filter clogging
7		Red	Fixed	Hydraulic oil high temperature
8		Green	Fixed	Forward movement engaged
9		Red	Fixed	Parking brake engaged

Position	Indicator light			Description
10		Red	Flashing	Brakes oil low level
			Fixed	Braking system failure
11		Green	Fixed	
12		Yellow	Fixed	Slow gear engaged *
13		Yellow	Fixed	Fast gear engaged *
14		Yellow	Fixed	Front axle wheels alignment *
15		Yellow	Fixed	Rear axle wheels alignment *
16		Green	Fixed	Backward movement engaged
17	-	-	-	Not used
18		Blue	Fixed	High beam
19		Green	Fixed	Direction indicators
21		Green	Fixed	Side lights
22	-	Red	-	Engine water high temperature
23	-	Yellow	-	Fuel reserve

* Indicator lights used depending on configurations or optional equipment.

Position	Indicator light			Description
24		Yellow	-	Not used
25		Yellow	-	Not used
26		Yellow	-	Not used
27		Red	-	Not used

8.3.2 Initial check

When the panel is switched on, the system will perform a check of all the indicator lights and all the indicators. During the check, the screen will show a loading bar "1" (fig. 150426-1).

After completing the initial check the display shows the main Home screen.

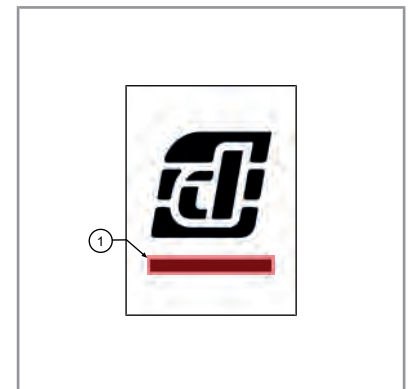

150426-1

8.3.3 Home

The Home screen (fig. 150428-1) is the standard display, containing the information required by the operator to use the vehicle.

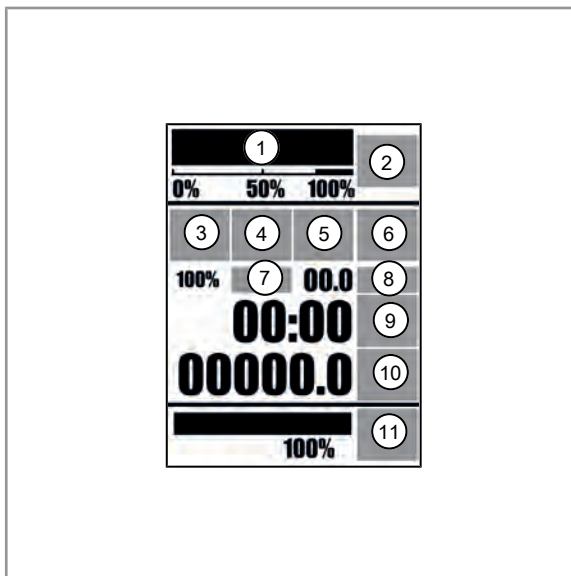

150428-1

Position	Description
1	Longitudinal momentum indicator [▶ 98]
2	Longitudinal momentum indicator [▶ 98]
3	General alarm icon [▶ 93]
4	Service [▶ 95] ByPass key [▶ 99]
5	Not used
6	Outriggers movement
7	Not used
8	Not used
9	Clock and clock setting [▶ 95]
10	Hour meter [▶ 96]
11	Not used

8.3.4 Central instrument panel: Menu







From the Home screen, it is possible to access the menu (fig. 150429-1) pressing the **MENU** key.

Use the **UP** and **DOWN** buttons to scroll through the menu items and press the **OK** button for 3 seconds to make a selection and go to the related page.



150429-1

The menu items are:

	Clock setting
	Active errors
	Check
	Service
	Anti-tipping calibration (Reserved to trained personnel)
	Info
	Settings (Reserved to trained personnel)

8.3.5 General alarm icon

The general alarm icon (fig. 150430-1) lights on together with other signals, to underline danger to the safety of the machine or the operator.



150430-1

If the machine is in motion, the General alarm icon is accompanied by a general alarm acoustic signal.

General alarm icon	Acoustic signal	Condition
On	Intermittent	Generator, battery failure
On	Intermittent	Engine oil low pressure
On	Intermittent	Engine air filter clogging
On	Intermittent	Hydrostatic oil filter clogging
On	Intermittent	
Intermittent	Continuous	Reached engine overspeed limit
Intermittent	Continuous	Reached maximum speed limit

8.3.6 Active errors

The presence of errors will be reported by the general warning icon, by the acoustic signal lasting 1.5 sec. and by the displaying of the error code on the Home screen instead of the time.



150432-1

In the presence of more than one error, the error codes will be displayed cyclically every 2 sec. on the Home screen. At the end of the cycle showing all the active errors, an icon will be displayed that indicates the user to access the Active Errors page to view all active errors in that time.

In case of an error from the SAR, the acoustic signal will be continuous and the error code will remain fixed on the Home screen. Press the **OK** button to stop the sound of the acoustic signal and resume the active errors displaying cycle.

To enter the Active errors page it is necessary to:

- Press the **MENU** button,
- Select the Active errors icon,
- Press the **OK** button,

Use the **UP** and **DOWN** buttons to scroll through the pages if there are several errors. The arrows at the bottom of page "1" indicate the presence and directions in which the additional pages flow.

Press the **MENU** button at any time to return to the Home screen.

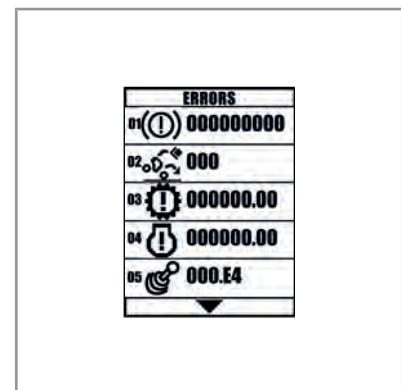

150432-2

Each error code is associated with an icon that identifies the nature of the error:

	Icon	Example	Description
01		000000000	Parking brakes errors or brakes failure
02		000	SAR errors
03		000000.00	Transmission errors
04		000000.00	Engine errors

	Icon	Example	Description
05		000.E4	Joystick errors

8.3.7 Service

The Service icon indicates intervals at which to carry out maintenance on the machine (fig. 150434-1).

20 hours before the deadline, the icon stays on for 3 seconds after switching on the instrument panel.

The Service indicator icon stays on permanently if, at the end of deadline, maintenance is not carried out by specialized personnel.

To find out the hours remaining to next maintenance, it is necessary to access the Service page (fig. 150434-2):

- Press the **MENU** button,
- Select the Service icon,
- Press the **OK** button.

To return to the Home screen, simply press the **MENU** button or select the **BACK** icon "1" and press the **OK** button.



150434-1

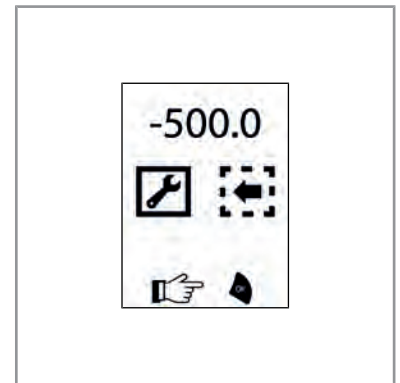

150434-2



NOTICE

Contact the Dieci technical service to perform maintenance and reset the Service hour counting.

8.3.8 Clock and clock setting

On the home screen there is the indication of the time next to the related icon (fig. 150439-1).

To adjust the time it is necessary to (fig. 150439-2):

- Press the **MENU** button,
- Select the clock setting icon,
- Press the **OK** button,
- Use the **UP** and **DOWN** to set the hour digits,
- Press the **OK** button,
- Use the **UP** and **DOWN** to set the minutes digits,
- Press the **OK** button to set the new time.

Press the **MENU** button at any time to cancel the process and return to the Home screen.



150439-1

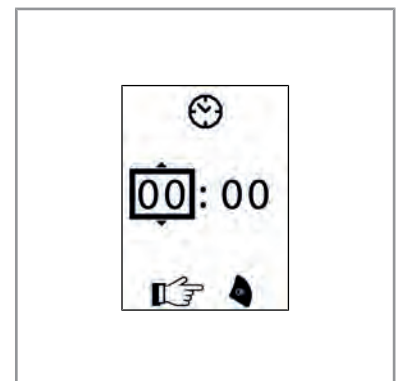

150439-2

8.3.9 Hour meter

On the home screen there is the indication of the hour meter next to the related icon (fig. 150440-1).

The separation of the decimal point flashes when the hour meter is active.



150440-1

8.3.10 Check page

The Check page allows to check some parameters of the vehicle:

- Boom absolute angle value (a)
- Boom extension values (L)
- Lateral direction tilt value (x)
- Longitudinal direction tilt value (y)

To access the Check screen it is necessary to: (fig. 150750-1):

- Press the **MENU** button,
- Select the Check icon,
- Press the **OK** button.

To return to the Home screen, simply press the **MENU** button or select the **BACK** icon and press the **OK** button.

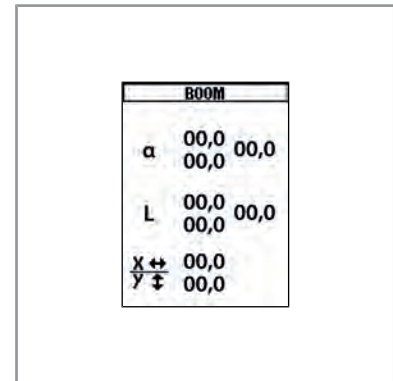

150750-1

8.3.11 Info page

The Info page provides information about the software version installed on the machine.

To access the Check screen it is necessary to: (fig. 150751-1):

- Press the **MENU** button,
- Select the Info icon,
- Press the **OK** button.

To return to the Home screen, simply press the **MENU** button or select the **BACK** icon and press the **OK** button.

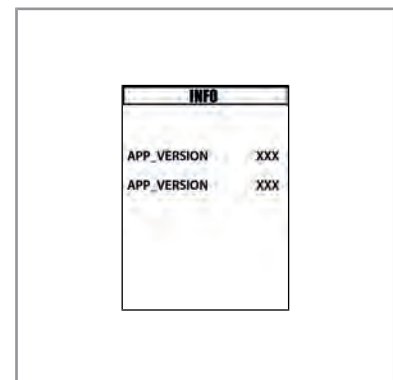

150751-1

8.3.12 Anti-tipping device

The device detects the longitudinal stability condition of the machine by measuring the residual load bearing on the rear axle.

The device is composed of:

- Longitudinal momentum indicator "1" and "2" (fig. 150431-1)
- Bypass key (fig. 150431-2)
- Operating modes (fig. 150431-3)

The device is always in operation.

The device is not intended for warning about the anti-tipping risk in case of:

- Transverse overturning
- A sudden overload,
- Transport/movement with the load in an elevated position,
- Movement on rough terrain, with obstacles or holes;
- Transport/movement on a slope or in the vicinity of a slope;
- High speed of movement on straight lines and on turns.

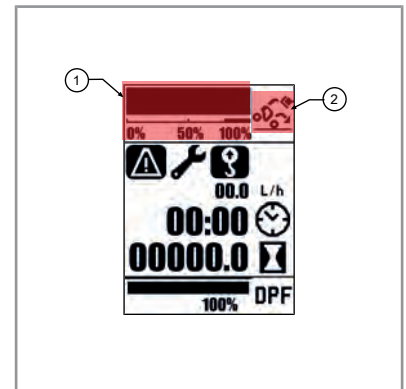

150431-1



150431-2

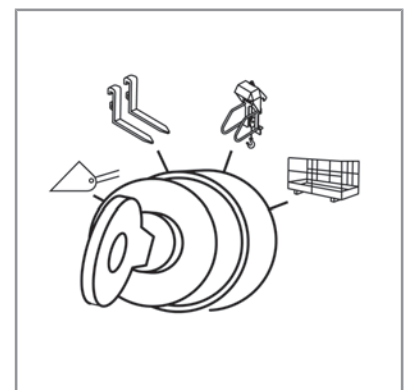

150431-3



CAUTION

When the limit load is reached, the device automatically locks all the aggravating movements for the stability of the machine. Only the movements that allow to return the machine in safety conditions will remain active.

8.3.12.1 Longitudinal momentum indicator

The tipping indicator is displayed by a bar "1" (fig. 150435-1), which indicates the vehicle risk of tipping.

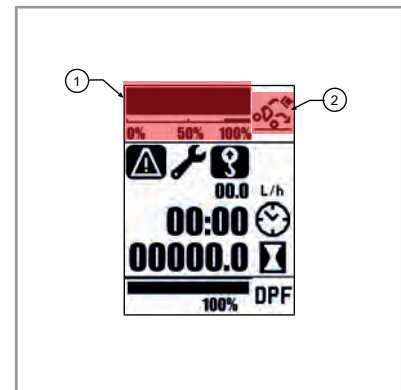

150435-1

The icon "2" has several icons and statuses depending on the working conditions of the machine.

Icon	Status	Condition
	Steady on	Normal work
	Flashing	Pre-alarm
	Steady on	Alarm

8.3.12.2 ByPass key



DANGER

Danger of tipping

The ByPass Key must be used only if all of the following conditions occur:

- a) In case the maximum tipping limit and danger of vehicle overturning has been reached.
- b) By skilled and properly trained personnel
- c) For short periods of time
- d) In case it is not possible to restore the safety conditions through the roller on the joystick to retract the boom.

The ByPass Key (fig. 150436-1) is with hold down action, therefore, must be maintained rotated during the operation for setting the machine in safe conditions.

When using the ByPass key, the display will show the related icon "3" (fig. 150436-2).

The ByPass Key function turns off automatically after 30 seconds, even if the key continues to be rotated.

After reaching the safety zone, the alarm stops and the ByPass key can be released.



150436-1

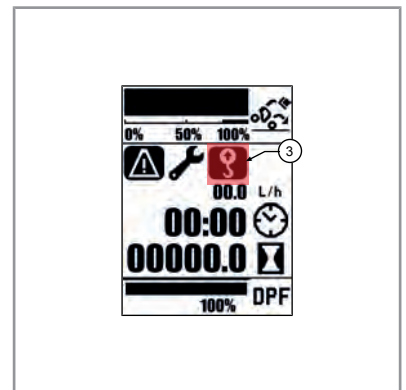

150436-2



DANGER



DO NOT MAKE THE DESCENT OR THE EXTENSION OF BOOM MOVEMENTS AS THEY ARE AGGRAVATING MOVEMENTS FOR THE TIPPING.

When using the bypass key, only make the return or the slope of the telescopic boom, bringing this in safety situation.



WARNING



When using the bypass key the anti-tipping systems are disabled.

It is mandatory to consult the capacity diagram of the machine and the equipment installed before performing any maneuver.

Use the inclinometer and the letters on the boom to know the exact position of the load.

In these conditions do not perform aggravating movements for the stability of the machine, there is a danger of loss of stability and tipping.



NOTICE

The bypass function is performed by a key to give the possibility to the Safety Officer to extract the key to prevent deactivating the anti-tipping system during normal working conditions.

8.3.12.3 Operating modes key

The machine is designed for use with different types of equipment, therefore it is necessary to set the correct operating mode according to the equipment used at that time.

To select the operating mode required for the equipment, use the operating mode key moving it to the work mode symbol (fig. 150437-1).

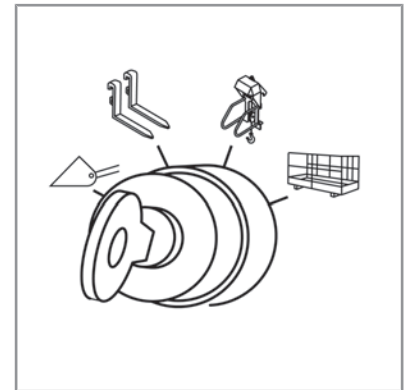





150437-1



NOTICE

The operating mode selection function is performed by a key to give the possibility to the Safety Officer to extract the key preventing to use an incorrect work mode related to the equipment.

The operating modes are:

Symbol	Operating mode	Description	Combined equipment
	Bucket	To be used during digging	<ul style="list-style-type: none"> – Bucket – Mixing buckets
	Telescopic elevator	To be used to transport materials	<ul style="list-style-type: none"> – Forks – Ladle – Material basket
	Truck crane	To be used to lift materials	<ul style="list-style-type: none"> – Equipment with hook – Equipment with winches
	Elevating work equipment *	To be used for lifting persons, it enables the controls on the basket	<ul style="list-style-type: none"> – Man basket

* The "Elevating Work Platform" operating mode for lifting persons is provided only with the "Man basket pre-arrangement" option.



WARNING

It is forbidden to use the machine with equipment other than that selected using the "Operating mode selector".

The equipment applicable to machines in question refer to **DIECI** price list.

Operating mode: Bucket

Bucket Mode, boom fully retracted, the anti-tipping device is automatically disabled. In case the boom is extracted or is subsequently extracted the operation will be with the same mode of the forks.

In this mode:

- The device always works properly and only indicates the load status.
- With closed boom the acoustic signal is not working to report the status of the load, but it starts operating only for reporting system errors.



DANGER

If equipment other than that specified being combined equipment is used in "Bucket" mode there is a risk of tilting.

Operating mode: Elevating work platform



WARNING

It is allowed to use the basket from the cab with "forks" operating mode only to return the basket to the ground in the event of illness or injury of the operator is in it.

8.3.12.4 Operation check with anti-tipping device load



CAUTION

It is mandatory to check the proper operation of the anti-tipping device at the beginning of each work restart.

For a proper check of the device carry out the following operations (fig. 150438-1):

- Place the machine on a flat, level surface and engage the parking brake.
- Make sure that the equipment is properly installed on the machine and that it is suitable for its capacity.
- Check that the display of the anti-tipping device is set for the equipment installed.
- Check that the oil in the hydraulic system is at approx. 50°C - 60°C.
- Refer to the capacity diagram of the equipment installed and with closed boom pick up a load approximately weighing 50% of maximum capacity.
- Raise the load at about 50 cm from the ground.
- With the engine idling, extend the boom slowly. During this operation, check the display of the anti-tipping device. When the red zone is reached, the continuous audible signal will operate and the extension movement will stop simultaneously.
- At this point, check that aggravating movements for the equipment assembled are not permitted.
- Check that the stopping occurs at the point indicated in the capacity diagram shown in notebook inside the cab.
- In the event that everything is working properly, it is possible to begin the work.

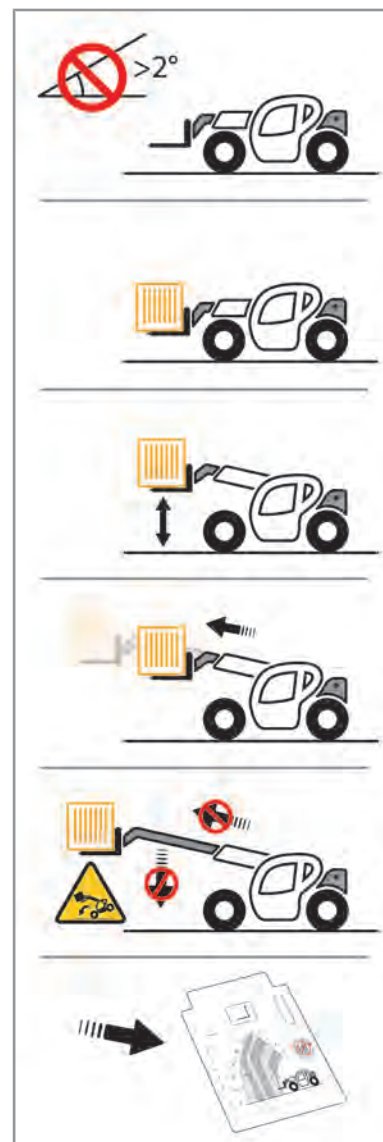

150438-1



DANGER

If there are any faults of the safety devices, stop the work until it has been repaired.

Contact the **Dieci** service center.

8.3.12.5 Anti-tipping device errors list



NOTICE

In case the machine is in error, contact a **Dieci** service center to solve the problem, indicating the error code reported.

For more information about the errors display, refer to the "Central instrument panel" chapter.

Icon	Example	Description
	000	SAR errors

Error code	Description
11	CRC error in the memory area that contains the software
12	CRC error in the memory area that contains the parameters
13	Program flow control error
14	Data exchange error between the two micro controls
15	Out of range +7Vdc, +18Vdc power supply voltage error
16	Internal power supply voltage of the first channel out of range 4.8 Vdc, 5.2Vdc error
17	Internal power supply voltage of the second channel out of range 4.8 Vdc, 5.2Vdc error
21	Cut Off1 output status consistency error
22	Cut Off 2 output status consistency error
23	WDO1 output status consistency error
24	Output 1 status consistency error
25	Output 2 status consistency error
26	WDO2 output status consistency error
31	Load cell A: CRC error of the load cell internal parameters.
32	Load cell A: Off range signal reading error (10-990)
33	Load cell A: Internal off range offset reading error (466-526)
34	Load cell A: Internal 5Vdc power supply error
35	Load cell A: Thermal calibration not present error
36	Load cell A: LIN bus message check error
37	Load cell A: Transmitted data CRC error
38	Load cell A: LIN bus message receiving error
39	Load cell A: LIN bus message control meter error
41	Load cell B: CRC error of the load cell internal parameters
42	Load cell B: Off range signal reading error (10-990)
43	Load cell B: Internal off range offset reading error (526-586)
44	Load cell B: Internal 5Vdc power supply error
45	Load cell B: Thermal calibration not present error
46	Load cell B: LIN bus message check error
47	Load cell B: Transmitted data CRC error
48	Load cell B: LIN bus message receiving error
49	Load cell B: LIN bus message control meter error
51	Too big difference between the readings of load cells A and B

Error code	Description
52	Too big difference between load rates detected by channels 1 and 2
61	Outriggers on the ground safety double input consistency error.
62	Closed boom reading safety double input consistency error
63	Mode selector inputs consistency error
64	Exclusion key active at the start up error
65	Movements in block reset input active at the start up error.
66	Frequency feedback signal reading error
67	External actuator 1 feedback signal reading error
68	External actuator 2 feedback signal reading error
71	Analog signal from joystick out of range reading signal error
72	Pressure transducer for joystick reset check reading error
73	CAN BUS messages receiving from the optional external unit error
81	Buttons pressed at the start up error
90	Message Counter error (10FF80E3)
91	Message Timeout error (10FF80E3)
92	Message Counter error (18FFF0E3)
93	Message Timeout error (18FFF0E3)
94	SARL response error, different response value
95	Calibration pin not connected any more during the calibration phase
96	Safe Road Traveling Position inconsistency error
97	Internal errors to the panel available
98	Internal errors to the panel available
99	Internal errors to the panel available

8.4 Transmission

8.4.1 Movement selection lever



CAUTION

In order to select a direction of movement, it is necessary to move the movement selection lever towards the steering wheel. This shifting protects the lever from accidental operation.

With the movement selection lever in position other than "N", it is not possible to start the engine.

The movement selection lever, at the left of the steering wheel (fig. 150457-1), allows to set the direction of travel of the vehicle.

- Pull the lever towards the steering wheel and push it forward ("F" direction) to proceed forward.
- Pull the lever towards the steering wheel and pull it back ("R" direction) to proceed in reverse. When driving in reverse, an alarm sounds intermittently.

While holding the lever in an intermediate position ("N") the transmission is in neutral and the vehicle is partially braked.

With the forward/reverse movement gear selection lever in position other than "N", the engine will not start.

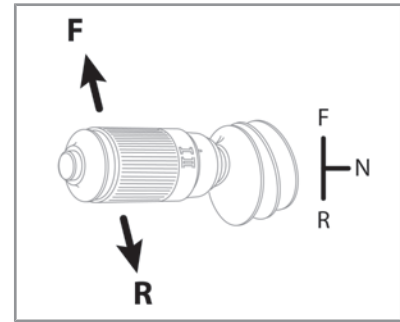

150457-1

After selecting a direction of movement, the corresponding indicator lights on the instrument panel turn on:

	"F" forward movement
	"R" reverse movement
-	While holding the lever in the intermediate "N" position the transmission is in neutral and both indicator lights will turn off.

The movements of the lever are not active when:

- The handbrake is engaged
- The operator is not properly seated in the driver's seat



NOTICE

If the operator is not sitting properly in the driver's seat, the transmission is automatically switched off.

To continue moving the vehicle, the operator must sit in the driver's seat and set the movement selection lever in position "N".



WARNING

After selecting the vehicle movement direction, it starts suddenly to move in the selected direction.

Before selecting the movement direction make sure that nobody is standing near the vehicle.



WARNING

It is dangerous to operate the movement selection lever with the engine at high rpm or at a speed higher than 2 km/h (1.2 mph).

Before reversing the direction of movement, minimize the engine speed and select the new direction. Danger of vehicle overturning severe breakage of mechanical parts.

8.4.2 Service braking pedal

Press the service brake pedal "1" (fig. 150311-1) to slow down or stop the vehicle.

The pedal acts directly on the service brakes inside the differential axles.

When the brake pedal is pressed the stop lights of the rear lights go on. The lights remain in operation until the pedal is released.

Periodically check that both lights are working.

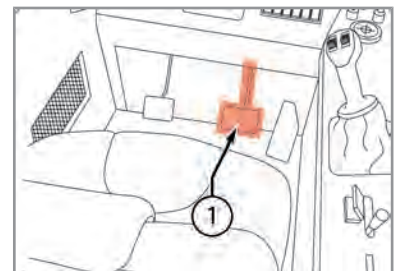

150311-1



150311-2

**WARNING**

In the case of restricted use of the pedal periodically check its proper operation. In case of problems contact the **Dieci** service center.

**DANGER**

If the warning light (fig. 150311-2) turns on intermittently, it indicates a low brake fluid level.

If the warning light (fig. 150311-2) turns on in a fixed way, the parking brake is stuck or damaged.

Do not use the vehicle until the problem has been solved. Contact a **Dieci** service center.

8.4.3 Inching Pedal

The inching pedal "1" (fig. 150740-1) acts directly on the hydrostatic transmission and allows to slow down the vehicle forward movement.

The pedal allows slow and precise forward movements with high rpm heat engine.

With pedal fully pressed, the vehicle stops the forward movement.

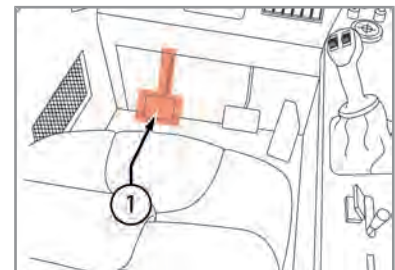

150740-1

**DANGER**

Do not press the inching pedal at high speeds, the vehicle brakes suddenly and the diesel engine risks over-revving.

8.4.4 Accelerator pedal

Press the accelerator pedal "1" (fig. 150741-1) to increase the engine speed, when the pedal is released the engine rpm will decrease.

The pedal acts directly on the injection pump of the engine.

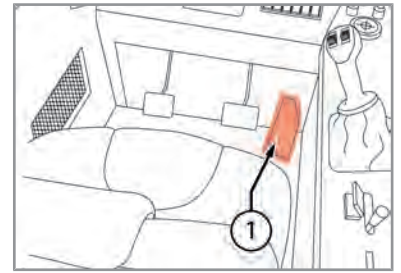

150741-1



WARNING

If while driving, the vehicle exceeds the maximum allowed speed, the "Over speed protection" transmission electronic control goes into operation. The function automatically limits the vehicle speed in order to prevent drive and diesel over revving. Triggering of the "Over speed protection" function is signaled by the general alarm indicator light switching on and the intermittent acoustic signal.

If the function intervenes, the operator must lift his foot from the accelerator pedal and reduce the speed of the vehicle.



NOTICE

The maximum speed of the vehicle varies with the inflation pressure and the size and wear of the tires.

8.4.5 Transmission manual disable

NOTICE! In order to manually disable the transmission it is necessary to remove the lower protection plate; See the "Maintenance" chapter.

To disable the transmission it is necessary to open the ByPass valve.

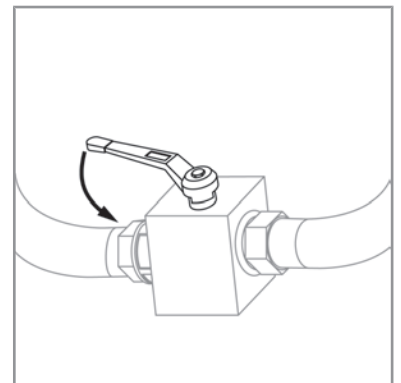

150561-1



WARNING

After the towing return everything to the initial conditions.

8.5 Mechanical steering selector

The steering selector (fig. 150313-1) is used to change the wheels steering mode:

To select a steering mode, move the lever indicating the corresponding symbol:

A - Front-steering wheels

This type of steering allows to carry out a steering with only the 2 front wheels.

B - Four-steering wheels

This type of steering allows to carry out the steering with all 4 wheels, so as to have the smallest turning radius possible.

C - Transverse

This type of steering allows a transverse or crab steering, so as to have a lateral displacement of the vehicle.

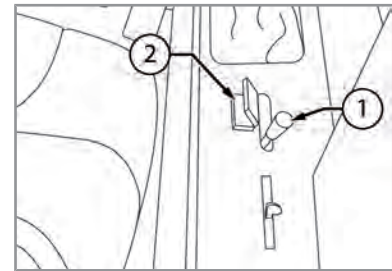

150313-1



DANGER

Make the steering selection only with the vehicle stopped.

Before selecting a new type of steering, align the wheels with stopped vehicle.



WARNING

When the transverse steering is selected, always operate at low speed.



CAUTION

For road travel is mandatory to select the 2-wheel steering mode and lock the selector with the dedicated fastener "2".

Manual wheel alignment



CAUTION

Perform the wheel alignment periodically (every 8-10 hours) depending on the continuous use of the machine.

During normal use of the machine, frequently changing the steering modes, it is possible that the wheels are no longer perfectly aligned with each other.

To perform a proper wheel alignment, perform the following steps:

1. Stop the machine on a level ground.
2. Select the **B** or **C** steering mode
3. Turn the steering wheel until the rear wheels are aligned to the machine.
4. Select the **A** steering mode
5. Turn the steering wheel until the front wheels are aligned to the machine.
6. Try to move slowly for a few meters to verify that the machine travels properly in a straight line.

If at the end of the alignment the machine still does not proceed in a straight line, repeat the wheels alignment.

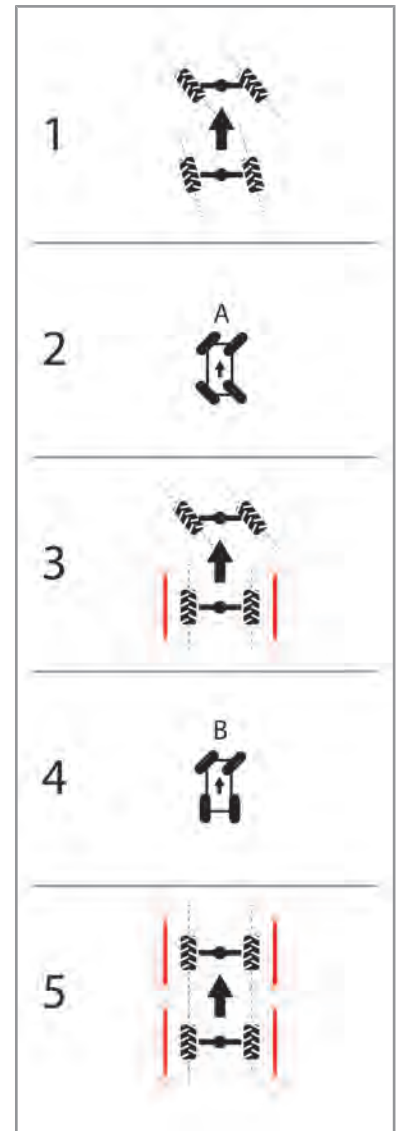

150312-2

8.6 Wheels alignment check *



NOTICE

The wheels alignment check is an optional accessory.



CAUTION

Perform the wheel alignment periodically (every 8-10 hours) depending on the continuous use of the vehicle.

During normal use of the vehicle, frequently changing the steering modes, it is possible that the wheels are no longer perfectly aligned with each other.

The wheels alignment check allows to quickly and accurately align the wheels.

To align the wheels using the Wheels alignment check function, it is necessary to (fig. 150315-1):

1. Stop the vehicle on a level ground.
2. Select the 4-wheel or transverse steering mode.
3. Press the button on side **"2"**.
4. Hold down the button and turn the steering wheel to bring the rear wheels aligned to the vehicle, until the light **"A"** comes on.
5. Select the 2 front wheel steering mode.
6. Press the button on side **"1"**.
7. Hold down the button and turn the steering wheel to bring the rear wheels aligned to the vehicle, until the light **"B"** comes on.
8. Now the wheels alignment is complete.

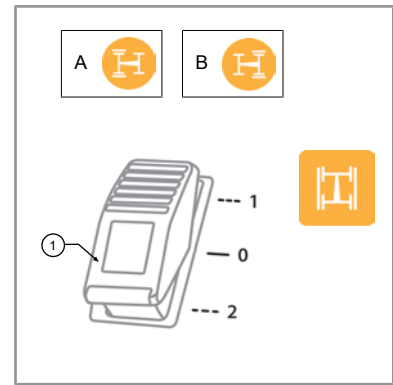

150315-1

8.7 Joystick

8.7.1 Joystick with mechanical deadman button

Joystick with standard mechanical deadman button.

The Joystick allows you to operate all the telescopic boom movements.

It consists of (fig. 150451-1):

1. Grip
2. "Deadman" button
3. Extension/retraction roller
4. Services roller
5. Continuous oil function button **
6. Continuous oil function active led **

** Components depending on optional equipment or pre-arrangements.

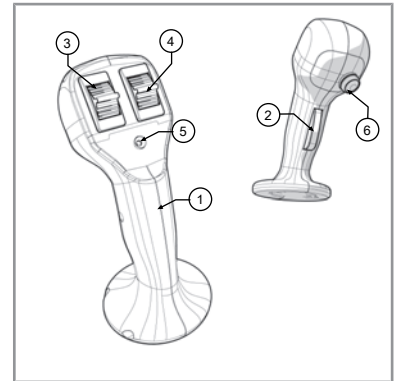

150451-1



CAUTION

The deadman joystick function prevents any accidental movements of the boom.

The Joystick is with mechanical "deadman" sensor: to enable its operation it is necessary to hold down the deadman button "2" on the handle of the joystick itself for the duration of the operation.

Without pressing the Deadman button, all joystick functions are disabled.



WARNING

Before operating the boom, make sure that the area around the machine is clear.

Make sure that the loads to be lifted are within the machine's capacity.

The movements that are possible using the joystick are:

CONTROL	MOVEMENT	
Grip forwards	Boom down	
Grip backwards	Boom up	
Grip to the left	Tilt upwards	
Grip to the right	Tilt downwards	

CONTROL		MOVEMENT	
Extension/retraction roller forwards		Boom extension	
Extension/retraction roller backwards	roller	Boom retraction	
Services roller forwards		Oil to the hydraulic coupler selected (color blue or sign "+")	
Services roller backwards		Oil to the hydraulic coupler selected (color red or sign "-")	



NOTICE

The joystick controls correspond to proportional movements of the machine.

Joystick with capacitive deadman switch with FNR function.

The Joystick allows you to operate all the telescopic boom movements.

It consists of (fig. 150451-2):

1. Grip
2. "Deadman" button
3. Extension/retraction roller
4. Services roller
5. F/R roller (forward/backward)
6. N button (idle)
7. Active F/R led
8. Continuous oil function button **
9. Continuous oil function active led **

** Components depending on optional equipment or pre-arrangements.

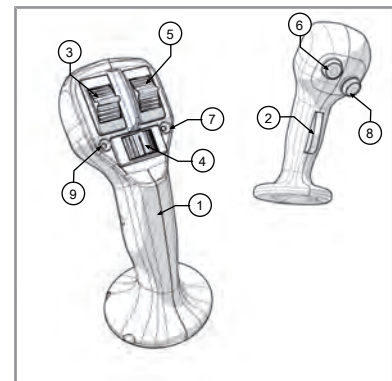

150451-2

The active F/R function LED "9" and the active continuous oil function LED "8", flash when the related function is being used.



WARNING

The F/R roller and the N button do not need the deadman enable to operate

To enable the F/R roller (forward / backward) is necessary to maintain the movement of the selector lever in N.

The controls given by the movement selector lever will have priority over those of the joystick.



CAUTION

The deadman joystick function prevents any accidental movements of the boom.

The Joystick is with mechanical "deadman" sensor: to enable its operation it is necessary to hold down the deadman button "2" on the handle of the joystick itself for the duration of the operation.

Without pressing the Deadman button, all joystick functions are disabled.



WARNING

Before operating the boom, make sure that the area around the machine is clear.

Make sure that the loads to be lifted are within the machine's capacity.

The movements that are possible using the joystick are:

CONTROL	MOVEMENT	
Grip forwards	Boom down	
Grip backwards	Boom up	
Grip to the left	Tilt upwards	
Grip to the right	Tilt downwards	
Extension/retraction roller forwards	Boom extension	
Extension/retraction roller backwards	Boom retraction	
Services roller forwards	Oil to the hydraulic coupler selected (color blue or sign "+")	

CONTROL	MOVEMENT	
Services roller backwards	Oil to the hydraulic coupler selected (color red or sign "-")	
F/R roller forwards	The machine runs in forwards gear (F)	
F/R roller backward	The machine runs in reverse gear (R)	
N button pressed	The F/R function is deactivated and the machine returns to neutral (N)	



NOTICE

The joystick controls correspond to proportional movements of the machine.

8.7.2 Joystick for man basket prearrangement

Joystick with standard mechanical deadman button.

The Joystick allows you to operate all the telescopic boom movements.

It consists of (fig. 150452-1):

1. Grip
2. "Deadman" button
3. Extension/retraction roller
4. Services roller

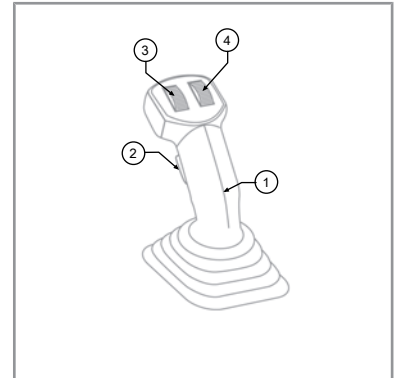

150452-1



CAUTION

The deadman joystick function prevents any accidental movements of the boom.

The Joystick is with mechanical "deadman" sensor: to enable its operation it is necessary to hold down the deadman button "2" on the handle of the joystick itself for the duration of the operation.

Without pressing the Deadman button, all joystick functions are disabled.



WARNING

Before operating the boom, make sure that the area around the machine is clear.

Make sure that the loads to be lifted are within the machine's capacity.

The movements that are possible using the joystick are:

CONTROL	MOVEMENT	
Grip forwards	Boom down	
Grip backwards	Boom up	
Grip to the left	Tilt upwards	
Grip to the right	Tilt downwards	
Extension/retraction roller forwards	Boom extension	

CONTROL		MOVEMENT	
Extension/retraction backwards	roller	Boom retraction	
Services roller forwards		Oil to the hydraulic coupler selected (color blue or sign "+")	
Services roller backwards		Oil to the hydraulic coupler selected (color red or sign "-")	



NOTICE

The joystick controls correspond to proportional movements of the machine.

8.7.3 Joystick error list



NOTICE

In case the vehicle is in error, contact a **Dieci** service center to solve the problem, indicating the error code reported.

For more information about the errors display, refer to the "Central instrument panel" chapter.

Icon	Example	Description
	000.E4	Joystick errors

CODE	COMPONENT	ALARM
006.E4		Power supply voltage 5V low with Engine ON
007.E4		Power supply voltage 5V high with Engine ON
010.E4	SAR	Invalid input voltage
011.E4		Invalid input voltage
015.E4		SLOW MOTION signal inconsistent with the active SAR alarm Pre-Alarm not active
016.E4		SAR alarm active
017.E4		SLOW MOTION pre -alarm active
018.E4		Inconsistency between 2 CUT OFF signals
025.E4	Hand Throttle	One of the 2 switches pressed or broken at the ENGINE START
026.E4		Pressed simultaneously
030.E4	Pedal Throttle	Redundancy control out of tolerance
031.E4		At least one signal out of range
041.E4	Swiveling Rod Microswitch	ENGINE START with mechanical lever not released or broken microswitch
050.E4	FNR	Invalid input voltage

CODE	COMPONENT	ALARM
090.E4	Power supply +5Vdc	Output voltage lower than the lower limit of operation of the Joystick and of the rotation sensor (Control Unit Malfunction)
091.E4		Output voltage higher than the upper limit of operation of the Joystick and of the rotation sensor (Control Unit Malfunction)
101.E4	SWITCH JOYSTICK	ENGINE START with deadman switch not released or broken
110.E4	Roller JOYSTICK	Redundancy control out of tolerance
111.E4		At least one signal out of range
114.E4		Redundancy control out of tolerance
115.E4		At least one signal out of range
118.E4		Redundancy control out of tolerance
119.E4		At least one signal out of range
140.E4	Low Idle Up solenoid valve	Output not commanded but a too high current consumption has been detected
141.E4		Output commanded but a too low current consumption has been detected
142.E4		Output commanded but a too high current consumption or a short circuit have been detected
145.E4		Button pressed during the engine starting
150.E4	Solenoid valve Distributor	Not commanded but a current consumption exceeding the threshold has been detected (Control Unit Malfunction)
151.E4		Commanded but the control unit does not detect a current consumption exceeding the threshold (Control Unit or Distributor Malfunction)
152.E4		Output commanded but the control unit detects a high consumption (Control Unit or Distributor Malfunction)
160.E4	Solenoid valve Servo control	Not commanded but a current consumption exceeding the threshold has been detected (Control Unit Malfunction)
161.E4		Commanded but the control unit does not detect a current consumption exceeding the threshold (Control Unit or Distributor Malfunction)
162.E4		Output commanded but the control unit detects a high consumption (Control Unit or Distributor Malfunction)
170.E4	Forward Command	Not commanded but a current consumption exceeding the threshold has been detected (Control Unit Malfunction)
172.E4		Output commanded but the control unit detects a high consumption (Control Unit or Distributor Malfunction)
180.E4	Reserve Command	Not commanded but a current consumption exceeding the threshold has been detected (Control Unit Malfunction)
182.E4		Output commanded but the control unit detects a high consumption (Control Unit or Distributor Malfunction)

CODE	COMPONENT	ALARM
190.E4	Transmission Disconnect Command	Not commanded but a current consumption exceeding the threshold has been detected (Control Unit Malfunction)
192.E4		Output commanded but the control unit detects a high consumption (Control Unit or Distributor Malfunction)
200.E4	Extension OUT distributor solenoid valve command	Not commanded but a current consumption exceeding the threshold has been detected (Control Unit Malfunction)
201.E4		Commanded but the control unit does not detect a current consumption exceeding the threshold (Control Unit or Distributor Malfunction)
202.E4		Output commanded but the control unit detects a high consumption (Control Unit or Distributor Malfunction)
210.E4	Extension IN distributor solenoid valve command	Not commanded but a current consumption exceeding the threshold has been detected (Control Unit Malfunction)
211.E4		Commanded but the control unit does not detect a current consumption exceeding the threshold (Control Unit or Distributor Malfunction)
212.E4		Output commanded but the control unit detects a high consumption (Control Unit or Distributor Malfunction)
220.E4	Auxiliary distributor A solenoid valve command	Not commanded but a current consumption exceeding the threshold has been detected (Control Unit Malfunction)
221.E4		Commanded but the control unit does not detect a current consumption exceeding the threshold (Control Unit or Distributor Malfunction)
222.E4		Output commanded but the control unit detects a high consumption (Control Unit or Distributor Malfunction)
230.E4	Auxiliary distributor B solenoid valve command	Not commanded but a current consumption exceeding the threshold has been detected (Control Unit Malfunction)
231.E4		Commanded but the control unit does not detect a current consumption exceeding the threshold (Control Unit or Distributor Malfunction)
232.E4		Output commanded but the control unit detects a high consumption (Control Unit or Distributor Malfunction)
240.E4	Hydraulic power function	Output not commanded but a too high current consumption has been detected
242.E4		Output commanded but an anomalous current consumption or a short circuit have been detected

8.8 Continuous oil function *



NOTICE

The oil continuous function is an accessory option.

The continuous oil function allows to maintain a constant volume of oil passing through the hydraulic sockets without acting consistently on the selector of the joystick.



DANGER

Do not change the hydraulic couplers selection while using the continuous oil function; the hydraulic coupler would begin to work directly according to the flow set by the function.

Risk of damage to things, people and mechanics of the machine or equipment.



CAUTION

With the continuous oil function enabled do not move away from the driver's cab.



NOTICE

With the continuous oil function active it is still possible to use the joystick to move the boom.

8.8.1 Continuous oil function on Joystick with mechanical deadman

To activate the function it is necessary to (fig. 150456-1):

- Select, using the hydraulic couplers switch and the coupler switch on the boom head (if installed), the desired hydraulic coupler on which to activate the function.
- Use the services roller on the joystick to set the desired flow of oil.
- Maintain the flow of oil through the services roller and simultaneously press the button "6" to activate the continuous oil function.

The LED **5** coming on, on the joystick, indicates that the continuous oil function is active.

To disable the function it is necessary to:

- Press the button "6".

When the LED "5" on the joystick goes off it indicates that the continuous oil function is disabled.

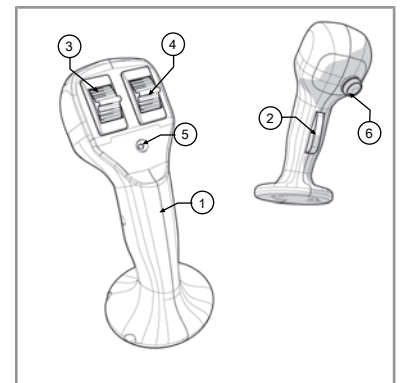

150456-1

8.8.2 Continuous oil function for vehicles with man basket function

To enable the continuous oil function it is necessary to (fig 150457-1):

1. Select, using the hydraulic couplers switch and the coupler switch on the boom head (if installed), the desired hydraulic coupler on which to activate the function.
2. Use the joystick control used for services (service roller or lever) to set the desired oil flow rate.
3. Press the switch "1" to enable the continuous oil function.

When the indicator light "2" next to the button "1" flashes it indicates that the continuous oil function is active.

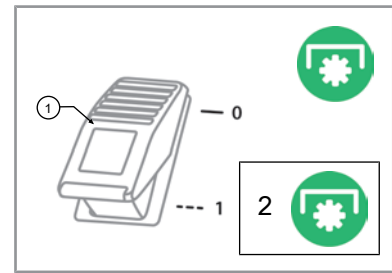

150457-1



WARNING

The continuous oil function is disabled temporarily when the joystick is moved without pressing the "Deadman" button.

The continuous oil function will resume as soon as the joystick returns to the rest position.

8.9 Rear hydraulic sockets *



NOTICE

* The rear hydraulic sockets are an optional equipment.

The hydraulic sockets switch (fig. 150990-1) allows the operator to select which hydraulic switches must be operated by the joystick and is present only on vehicles that are equipped with rear hydraulic sockets.

Press the rear hydraulic sockets switch to enable the rear hydraulic sockets. The warning light on the switch indicates its operation.

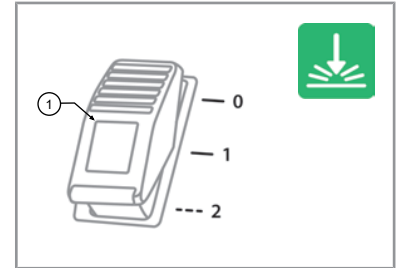

150990-1



DANGER

Danger of moving the wrong hydraulic socket.

Do not operate the hydraulic sockets using the joystick during the selection of the hydraulic socket. Make the selection of the hydraulic socket and use the joystick to control the hydraulic socket selected only at a later time.

After connecting the equipment to the hydraulic sockets before starting the job, check in a safe location that all the controls are working properly. During the test, be careful not to create danger or damage to persons, animals or things.



WARNING

Pay attention to the connections of the hydraulic socket: moving the service lever placed on the joystick forward, towards the open padlock (see Joystick chapter) oil will be sent to the sockets marked with the color **BLUE** or by the symbol "+".

8.10 Hydraulic sockets and electrical contact on boom head *



NOTICE

* The presence and number of hydraulic sockets and electrical contacts present on the boom head may vary depending on optional equipment.

The sockets switch on the boom head (fig. 150203-1) has several functions and positions depending on the optional equipment installed on the vehicle.

Once selected the desired hydraulic socket, it is necessary to use the services lever on the joystick to operate the desired movement.

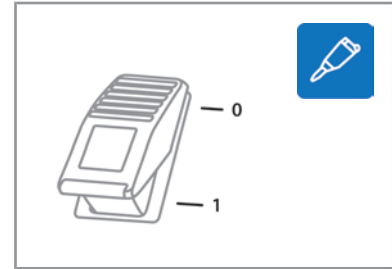

150203-1



DANGER

Danger of moving the wrong hydraulic socket.

Do not operate the hydraulic sockets using the joystick during the selection of the hydraulic socket. Make the selection of the hydraulic socket and use the joystick to control the hydraulic socket selected only at a later time.

After connecting the equipment to the hydraulic sockets before starting the job, check in a safe location that all the controls are working properly. During the test, be careful not to create danger or damage to persons, animals or things.



WARNING

Pay attention to the connections of the hydraulic socket: moving the service lever placed on the joystick forward, towards the open padlock (see Joystick chapter) oil will be sent to the sockets marked with the color **BLUE** or by the symbol "+".

Installation	Diagram	Switch description
Standard hydraulic socket + Electrical contact		0 - Electrical contact off 1 - Electrical contact on
Standard hydraulic socket + Additional hydraulic socket + Electrical contact		0 - Standard hydraulic socket 1 - Electrical contact on 2 - Additional hydraulic socket

8.11 Electrical contact on boom head *



NOTICE

* The electric contact on the boom head is an optional accessory.

At the socket of the electric contact on the telescopic boom head (fig. 150204-1) it is possible to connect:

- The plug of the solenoid valve of the Second Additional hydraulic socket
- The plug of any equipment installed on the tools holder plate.

To activate the electrical contact, place the Sockets switch on the boom head in position "1" - See table in the previous chapter.

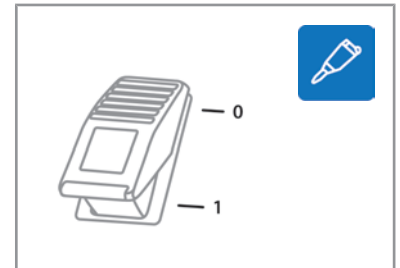

150204-1



NOTICE

For information on how to make the connections to the electrical socket, refer to the "Electrical connections" chapter.



WARNING

Do not connect users with nominal voltage greater than 12 V and amperage greater than 3 A.

Risk of damage to the electrical system.

8.12 Trailer descent *



NOTICE

* The Trailer Descent is an optional accessory available only on vehicles with closed center distributor.

The Trailer Descent allows to use trailers or equipment with single-acting cylinders, with any hydraulic sockets on the vehicle.

To put the socket under pressure it is necessary to:

- With the hydraulic sockets switch, select the rear socket on which the equipment or the trailer is installed.
- Use the services control to lift the caisson.
- After reaching the desired height release the control. The trailer will remain stationary in that position.

To relieve pressure from the socket it is necessary to:

- With the hydraulic sockets switch, select the rear socket on which the equipment or the trailer is installed.
- Press the Trailer Descent button (fig. 150308-1) and hold down until needed.

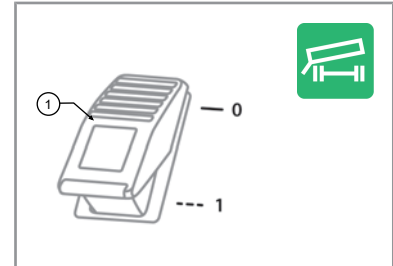

150308-1

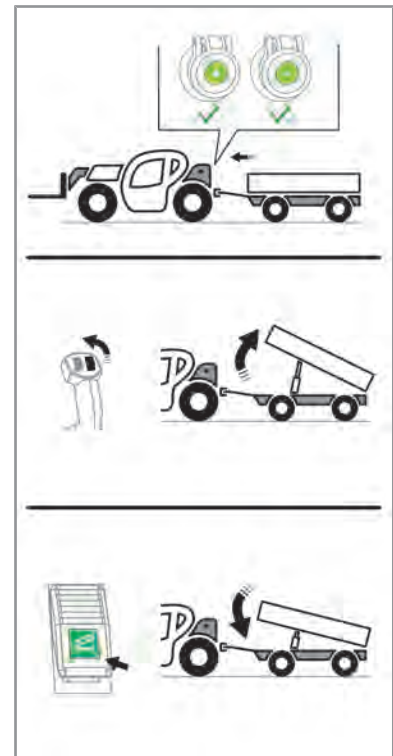

150308-2



DANGER

Danger of crushing.

When using the Trailer Descent, make sure that nobody is in range of the vehicle and if the trailer is connected to it.

8.13 Quick coupling



NOTICE

* The equipment quick coupling is an optional accessory.

The equipment quick coupling allows the operator to install and fasten the equipment to the tools holder plate.

There are different models of quick couplings for equipment, they can be with a single lock cylinder lock or double lock cylinder, the procedures for use change according to the type of hydraulic system of the vehicle.

To use the quick coupling (fig. 150206-7) for the equipment installation it is necessary to:

1. Carry out the normal hooking operations set out in paragraphs 1, 2, 3 and 4 of the chapter "Equipment installation".
2. Press the Quick Coupling button "1" (fig. 150206-8) and at the same time operate the roller on the services joystick to open the quick coupling.
3. Keep the quick coupling open, tilt the plate upward to make sure that the equipment is fully resting on the tool holder plate.
4. Release the roller on the services joystick and the Quick coupling button "1" to close the quick coupling and lock the equipment.
5. If the equipment is not properly fastened, repeat the installation.

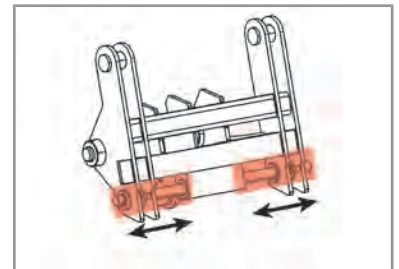

150206-7

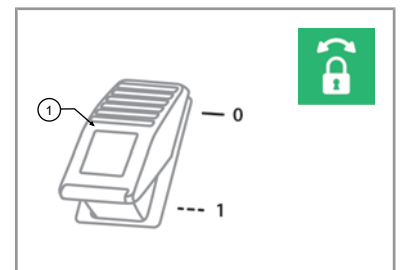

150206-8



DANGER

Do not operate without having properly secured the equipment to the plate, danger of load and equipment falling.

8.14 Electronic hand throttle

The hand throttle (fig. 150743-1) allows to maintain constant engine revolutions, without pressing the accelerator pedal.

- Press the Hand throttle on the top "1" to increase the engine revolutions of 200 rpm.
- Press the hand throttle on the bottom "2" to decrease the engine revolutions of 200 rpm.

To deactivate the function, press the accelerator pedal.

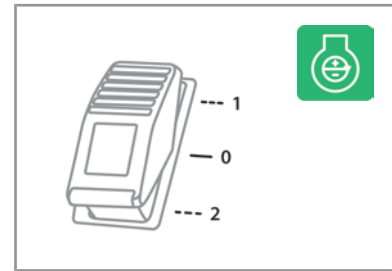

150743-1



CAUTION

With the hand throttle in operation, the machine travel is disabled.



CAUTION

When turning off the machine, the function must be disabled and the engine must be brought to the minimum speed.



WARNING

Do not use the electronic throttle in the cab during the use of the basket and/or of the remote control.



WARNING

Do not use the electronic throttle in the cab during the use of the basket and/or of the remote control.

8.15 Safety rod

The safety rod must be used as a safety measure during maintenance operations, to prevent the descent or fall of the boom in case of failures.



WARNING

DANGER OF CRUSHING

In case of maintenance to the boom lifting cylinder or the relative lock valve it is required to support the boom by means of an appropriate lifting device with minimum capacity of at least 3000 kg (6614 lb).

To insert the safety rod "1" (fig. 150459-1) operate as follows:

- Completely close the extensions of the telescopic boom
- Lift the boom to the minimum height necessary to apply the safety rod
- Apply the safety rod around the lifting cylinder rod

Lock the safety rod by means of the appropriate hooks "2".

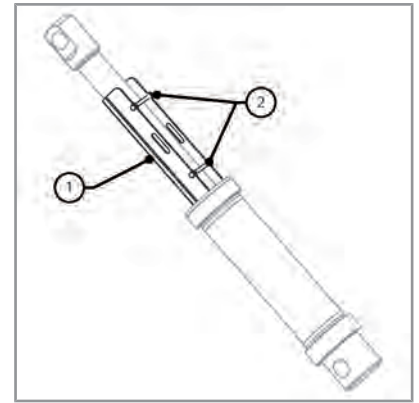

150459-1

8.16 Wheel wedge

The wheel wedge (fig. 150460-1) must be used as a safety measure to prevent accidental or unwanted movements of the vehicle.

It is advisable to use them when parking the vehicle during stops along slopes or during maintenance operations.

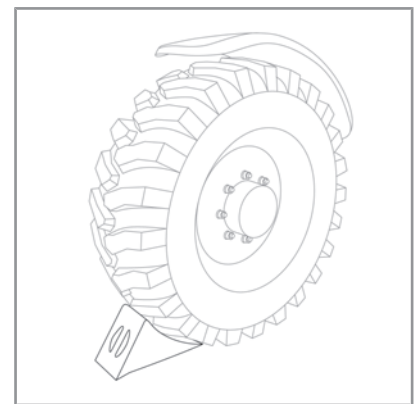

150460-1

8.17 Block valves

The block valves (fig. 150461-1) for cylinders prevent uncontrolled movement of the pistons of the cylinders in the event of hydraulic pressure failure or bursting of a hose.

The valves are installed directly on all the cylinders.

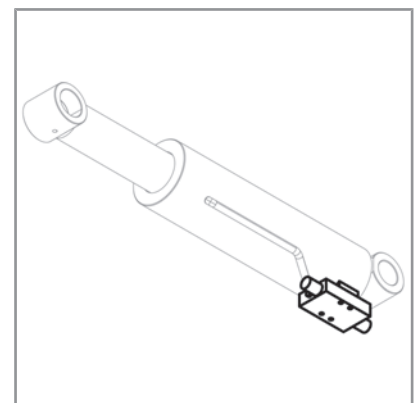

150461-1

8.18 Diagrams notebook

The diagrams notebook (fig. 150462-1) summarizes the main information for safe use of the machine for easy reference by the operator during the various processing phases.

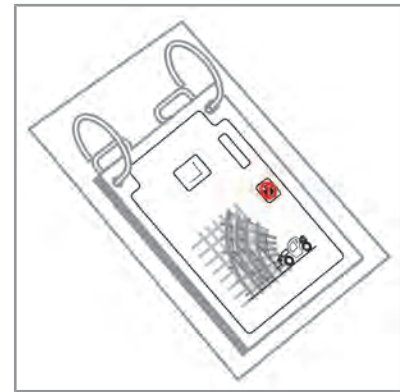

150462-1

8.18.1 Capacity diagrams

The Safe Working Load (SWL) of these machines depends on the extension extent and the boom angle.

The capacity diagrams show the maximum height and extent allowed by certain equipment and loads, in order to work safely, without the risk of tipping of the machine during work operations.

This machine is however equipped with an anti-tip device that monitors in real time the status of the load and the risk of tipping of the machine (see chapter "warning device"). It is however necessary to use and adhere to the capacity diagrams in relation to the load and type of accessory used.



CAUTION

It is mandatory to have in the cab, the capacity diagram referred to the equipment and the machine that is being used.

Refer to the correct capacity diagram before handling a load.



DANGER

Danger of tipping.

Do not raise or extend the boom when the machine is in motion. Fully lower and retract the boom before moving a load.



CAUTION

The capacity diagrams refer to stopped and leveled machine.



CAUTION

The diagrams of the machine and equipment being used must always be present in the Diagram notebook found in the cab, used by the operator.

Replace the capacity diagrams if they deteriorate, are damaged or lost.

The capacity diagrams are ordered just like spare parts (make sure you provide the relative identification code when placing the order).

Before handling a load it is necessary to:

- Consult the "Safe working procedures" chapter.
- It is mandatory to know the weight of the load that must be handled.

- Locate the center of gravity of the load to be moved. The center of gravity may not be at the center of the load.

8.18.1.1 Read the capacity diagrams

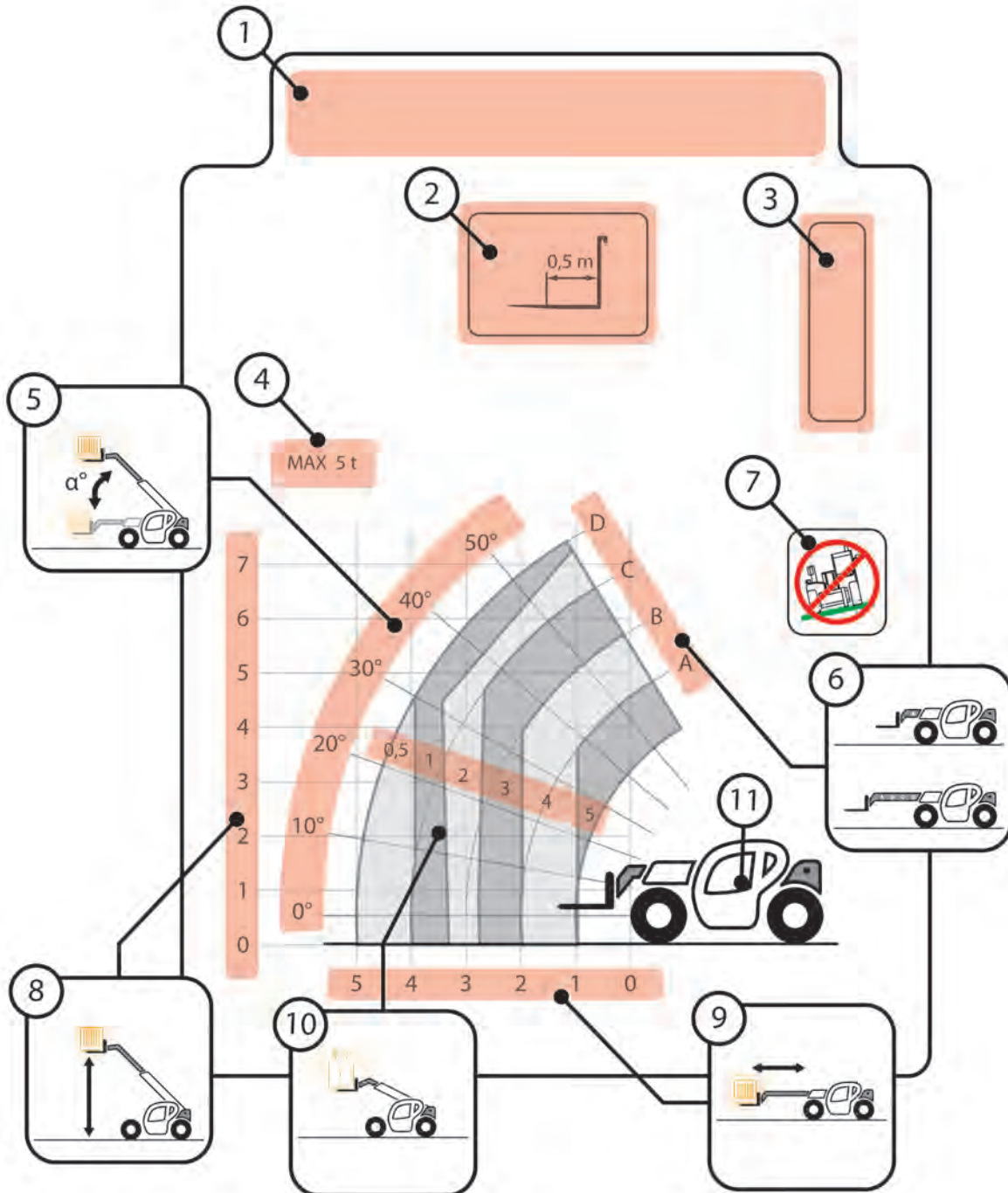

Illustration 6: 150464-1 - Capacity Diagram

1	Vehicle name and model
2	Equipment model Equipment model with the indications of center of the load.

	For more information, refer to the "Capacity diagrams legend" chapter.
3	Capacity Diagram code
4	Equipment maximum capacity The maximum Capacity of the equipment is also reported by the sticker placed on the equipment itself.
5	Boom angle The boom angle is indicated by the inclinometer on the left side at the end of the boom (if any), or on the display of the anti-tipping device (if present).
6	Boom extension The boom extension is indicated by letters of the alphabet ("A", "B", "C", "D", etc...). The same letters are shown as stickers on the boom extension, so that the user in the cab can know the boom extension by reading the letters on it.
7	Machine operating mode For more information, refer to the "Capacity diagrams legend" chapter.
8	Load height from ground
9	Horizontal distance of the machine load
10	Load weight
11	Machine position

8.18.1.2 Use the capacity diagrams

The capacity diagrams indicate the areas in which it is possible to operate with the machine and load in safe conditions.



DANGER

Danger of tipping.

Operating the machine without observing the Capacity diagrams related to the equipment installed may result in hazardous conditions, up to the tipping limit and the operation of the Anti-tipping device.

The whole working area of the boom is divided into these areas (position "1", fig. 150465-1). Each area corresponds to a maximum capacity. The area closest to the machine will have a capacity equal to the maximum loading capacity of the machine; as moving away from the machine, the maximum capacity of the areas decreases.

Before starting to work, it is necessary to know:

- Load weight
- Height from ground at which the load must be handled
- Distance from the machine at which the load must be handled

Locate the area of the capacity diagram, showing a value just above the weight of the load to be handled; for example if the load should weigh 1.5 tons, the area to which it is necessary to refer is the area with a capacity of 2 tons (position "1").

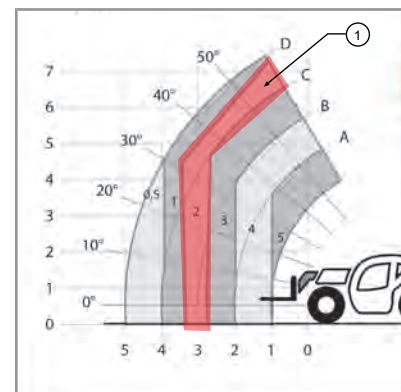

150465-1

Knowing the area, the following will be known:

- the vertical and horizontal distance to which it will be possible to handle the load
- the boom extension and angle values at which it is possible to operate.

In order to know the vertical and horizontal distance to which it will be possible to handle the load, use the horizontal and vertical lines that cross the reference area; for example, it will be possible to carry the load at a distance of 3 m from the machine and 4 m in height remaining in safety conditions (position "2", fig. 150465-2).

To avoid operating in conditions of tipping danger, use the boom angle and extension indications. For example, we could operate with the boom extended to letter C at an angle of 30° (position "3", fig. 150465-3).

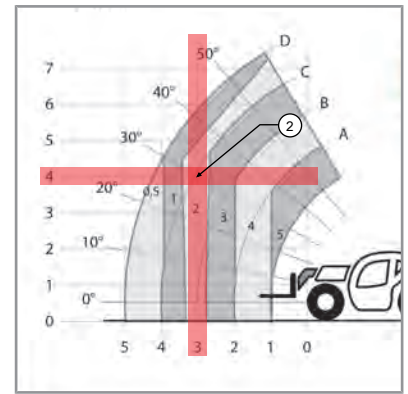

150465-2

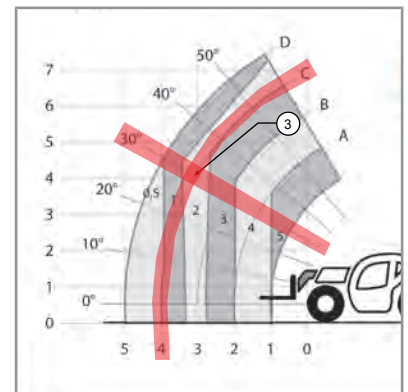

150465-3



DANGER

Taking the load beyond the permissible area, we would enter in danger conditions of tipping over and the anti-tipping device, locking all the movements considered aggravating to the stability of the vehicle and of the load.

Use the capacity diagrams for each load handling to determine the working area.

It is possible to start operating only under safety conditions and if within the predetermined safe work area.



8.18.1.3 Equipment legend for capacity diagrams



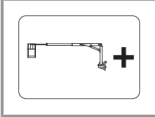
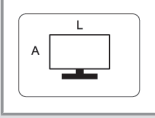
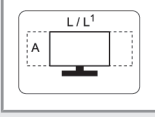
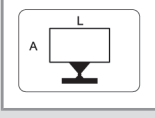
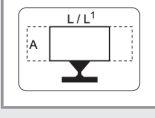
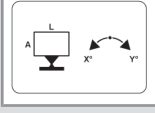

	Forks torque (capacity)
	Forks Spreader / Translator
	Winch (Capacity)

	Winch method of use: Single Tow
	Winch method of use: Double Tow
	Jib with hook (Dimensions)
	Lattice extension (Dimensions)
	"Gooseneck" jib (Dimensions)
	Hook for fork carrier plate
	Gripper for pipe with pipe locker
	Cylinders manipulating gripper
	Wheels manipulating gripper
	Sheets holding gripper
	5 teeth polyp-grab gripper
	Centering layer
	Negative jib

	Positive jib
	Fixed Front basket
	Extendible Front basket
	Fixed Trilateral basket
	Extendible Trilateral basket
	Trilateral basket (X° = Right rotation - Y° = Left rotation)

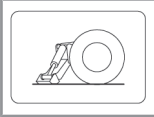
8.18.1.4 Operating modes legend for capacity diagrams

	Maximum pressure applied on the ground
	Prohibition of operating with unlevelled machine
	Stabilizers lowered, 0% extended
	Stabilizers lowered, 50% extended
	Stabilizers lowered, 100% extended
	Prohibited to work on tires
	Stabilizers lifted

	Stabilizers lowered
	Front position
	In non-continuous Rotation
	In continuous Rotation

8.19 Water heater *



NOTICE

The Water heater is an optional accessory.

The water heater is connected to its own control unit and is used to facilitate the ignition of the engine in the winter period or in case of cold climates.

The water heater is placed in the rear side of the bonnet.

To use the water heater it is necessary to:

- Make sure the vehicle is off.
- Enter the extension in the socket at the rear of the hood.
- Enter the extension in the **220 V** socket.
- Wait until the water is adequately heated.
- Remove the water heater extension from the socket and from the socket on the bonnet.

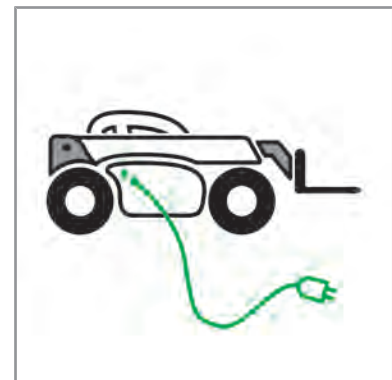

150493-1



DANGER

Do not use the water heater with the engine running or the machine in travel.



WARNING

Remove the water heater power connections before turning on and/or moving the machine.

Check the good condition of the power cord before starting up the device.



NOTICE

In case of malfunction contact the **Dieci** service center.

8.20 Fan reversal *



NOTICE

The fan reversal is an optional accessory.

The fan reversal allows precisely the radiator fan reversal to clean the radiator from any dirt deposits such as dust and straw.

To activate the reversible fan operate on the dedicated button (fig. 150306-1).

The cleaning cycle is activated automatically pressing the button, which should therefore not be held down.

The reversal is carried out automatically without having to stop the machine.

The fan will remain in the "cleaning" position (reversed motion) for a time set by the manufacturer.

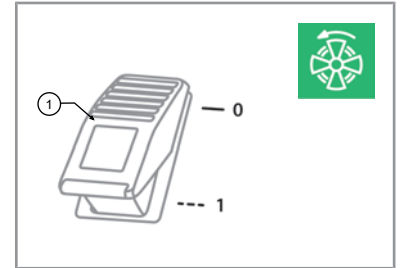

150306-1



CAUTION

The fan reversal presence does not exempt the user from cleaning the fan, radiator and engine compartment, at the intervals indicated by regular maintenance.

8.21 Boom suspension *



NOTICE

* The boom suspension is an optional accessory.

The boom suspension allows to make movements with the machine without being affected by the strong oscillations and jolting, caused by the boom, in the case of uneven ground.

The switch boom suspension has a safety lock to prevent accidental activation.

To activate the boom suspension, move the block "1" and simultaneously press the switch (fig. 150310-1).

The warning light on the switch indicates its operation.

The boom suspension is activated only if the telescopic boom is in horizontal position.

The boom suspension is automatically deactivated by pressing the "deadman" button on the joystick.

The suspension may also be used during the transport of loads, with the boom in transport position (fully retracted and in horizontal position).

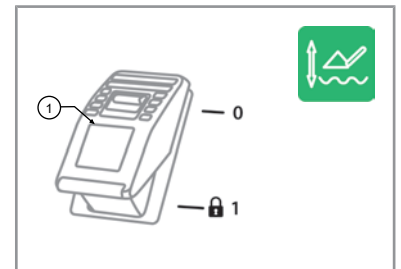

150310-1

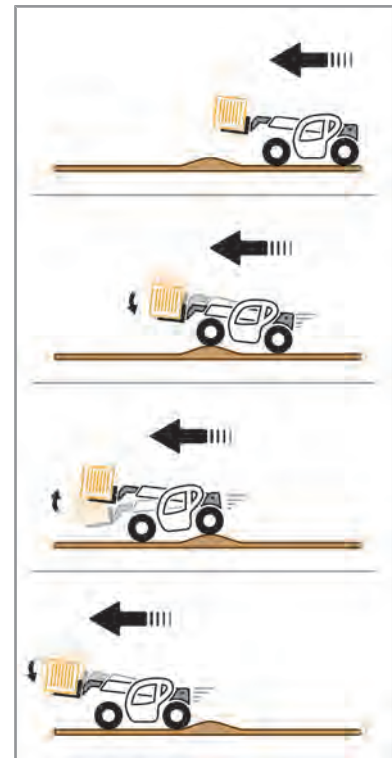

150310-2



WARNING

Activating the boom suspension, the boom may have a slight but sudden upward movement.

Before activating the boom suspension, make sure that the installed equipment and any load are properly secured to the machine and that there are no people, animals or objects within the operating range of the machine.



CAUTION

The presence of the boom suspension does not involve the increase of the transport speed and machine movement. The speed must always be proportional to the ground, to the place of use and to the atmospheric conditions.



NOTICE

The boom suspension is a device which entails an increase in the comfort of the machine, but it does not increase its safety characteristics.

8.22 Kubota engine Stage IIIA - Tier 3



NOTICE

The use and maintenance manual of the engine is an integral part of the documentation supplied with the machine.

Consult the engine manual or contact an authorized workshop for maintenance.

We recommend that you carefully read the information contained in the instruction manual and comply with them: in this it is possible to avoid accidents, enjoy the manufacturer's warranty and always have an engine in peak operating condition.

9 Equipment

9.1 General warnings on equipment use



DANGER

It is strictly forbidden to modify the structure of the equipment or adjust the safety devices of the various tool components.

- Only equipment CE certified by the relative manufacturer can be used on **DIECI** vehicles, as well as equipment approved or falling within the technical limits set out by **DIECI S.r.l.** The guarantee is void if not approved equipment is used.
- The interchangeable equipment manufacturer must guarantee that the combination of such equipment and the basic vehicle on which the equipment is intended for, meets all the basic health and safety requirements, providing an adequate evaluation procedure of compliance.
- **DIECI S.r.l.** liability shall not be involved if equipment use or modifications do not comply with the above mentioned requirements.



CAUTION

The equipment installed on the vehicle may only be used:

- a) on consistent ground and with vehicle level with maximum tilt of 2°.
 - b) by competent and qualified personnel who must have read this manual. In the case of road use refer to the Use and Maintenance Manual of the vehicle making sure that the operator is in possession of a valid driver's license in accordance with the laws in force in the country of use (license B or higher for ITALY), and that the vehicle boom is in the fully retracted position.
- Some equipment be accompanied by instructions related to safety standards, connection and disconnection, operation and maintenance. Carefully read and fully implement these instructions prior to installation, use and maintenance of the equipment. In case of doubt, contact your local dealer.
 - Before starting to use the vehicle and related equipment, or before performing particularly complex or dangerous operations, it is absolutely necessary to practice in a clear work area free from obstructions.
 - In case of poor visibility of the zone use a person on the ground to coordinate the movements and operations and that monitors the area inviting people who might come, to go away. The individual on the ground must stand at a safe distance from the vehicle in motion and alert, before any movement, any personal around.
 - To prevent damaging hydraulic connections when changing an equipment, stop the engine and wait a few seconds to remove pressure from the circuit. Always clean connectors before their reinsertion.
 - Check the cleanliness, protection and the conditions of quick release connections in the equipment circuits and on the boom head daily.



DANGER

Never carry the equipment in the vicinity of an open flame.



DANGER

When using the vehicle, carefully follow the respective Capacity diagrams.

It is strictly prohibited to work without the respective capacity diagrams for the type of vehicle and installed equipment.



- The indications given by the anti-tipping system of the vehicle must be considered valid for standard working conditions, on flat and solid ground with well-functioning and properly calibrated equipment. In any case, the values indicated by the capacity diagrams must be respected and never exceeded.
- It is mandatory, every time the equipment is used to insert the safety pins to secure the equipment to the tool holder plate.
- If a tool holder plate different from the original Dieci model is installed on the vehicle, a residual load will remain on the anti-tipping device of the vehicle as a safety factor.
- Refer to the manual of the manufacturer of the tool holder plate installed if different than the original Dieci tool holder plate.



CAUTION

When moving the vehicle with equipment or man baskets installed, maintain a speed appropriate to the type of ground.

When driving on rough terrain it is advisable not to exceed 10 km/h (6,2 mph) to prevent vibration and pitching, damaging the equipment or the man basket installed on the vehicle.



WARNING

Some tools in the fully retracted position may interfere with parts of the vehicle.

Pay due attention to prevent damage to the vehicle.

9.1.1 Equipment pre-use checks



NOTICE

Refer to the pre-use safety procedures of the vehicle on which the equipment is installed.

Before every use and every time new equipment is installed on the machine:

- Check that the equipment is properly hooked to all the pins and the hooks are inserted in the correct position.
- There is no damage, deterioration, deformation of the equipment locking components
- Check that the equipment and components are intact, perfectly functioning and not damaged.
- Verify that the equipment capacity is more than the weight of the load to be moved.
- Verify the correct functioning of the equipment and of the controls present in the vehicle cab on which the equipment is installed in a work zone free from personnel and obstacles.
- Verify the functioning of all indicators and lights present inside the vehicle on which the equipment has been mounted.
- Check the swiveling when empty.
- Check the oil level in the hydraulic circuit.
- Check that the safety symbols and stickers are clearly legible.
- Check the efficiency and functioning of the safety devices.
- Visually check the state of welding, inspect the vehicle and check for cavities, cracks of the welding or base metal or other inconveniences.
- Check for any deformations and/or modifications of the material due to sudden temperature changes or damage from impacts.
- Check the equipment for wear.
- Verify the use mode relating to the installed equipment has been set on the vehicle.
- Verify that the Capacity diagrams relating to the vehicle and installed equipment are present on the vehicle.

In case of equipment with hydraulic connections:

- Check that the tubes are in good conditions and do not obstruct the movements of the boom or of the equipment.
- Verify the correct connection of the hydraulic tubes (if present) ensuring that the equipment functions are not inverted.

In case of equipment with electrical connections:

- Check that the cables are in good conditions and do not obstruct the movements of the boom or of the equipment.
- Clean and fasten all the electrical connections (if present). Check before each work shift that there are no loose, twisted, hardened or damaged wires. Do not operate the operating machine if there are any loose, twisted, hardened or damaged electric cables.

In the event of radiocontrol pre-arrangement:

- Refer to the specific manual of the equipment for further checks.
- Verify the correct functioning of the radiocontrol/push button control panel and the charge status of the batteries.

In case lifting equipment is used

- Refer to the specific manual of the equipment for further checks.

- Verify the integrity of the lifting hook, including relative catch, and of the hook bolt to the rope.

In case winches are used

- Refer to the specific manual of the equipment for further checks.
- Check that the rope is not damaged, cut, torn, frayed. On the contrary, do not use the equipment and replace it. (This check can be carried out by fully extending the lift boom and unrolling the winch rope). During this operation it is also possible to check the operation of the limit switch, which must lock the rope according to the procedure described in the specific paragraph.
- Verify the functioning of the extensometric transducer of the mounted equipment (if present); to do this, try to lift a load slightly heavier than the nominal maximum capacity of the equipment. In case the equipment is unable to lift the load, the transducer operates correctly, otherwise immediately interrupt the operation bringing the load to the ground and repair the equipment.

In case of using elevating work platforms

- Refer to the specific manual of the equipment for further checks.
- Verify the operation of the emergency button of the load limiting device and of the area limiting device at the beginning of each work cycle
- Before using the platform ensure it is not wet, dirty with grease, oil, has icy surfaces or covered with other substances that can make its surface slippery. On the contrary, accurately clean the platform surfaces. Danger of slipping and falling.
- The vehicle on which the equipment is installed must be braked and stabilized on solid ground. If outriggers (optional) are present, position them correctly on the ground before starting to operate.
- Before operating, make sure that the platform closing bar is lowered and free from obstacles; always check correct fastening of the safety belts (PPE III cat.).



CAUTION

All checks must be carried out by adequately trained personnel and registered on the control log.

If damage or malfunctioning is detected, comply with the instructions contained in this manual or in the manual of the equipment or basket or contact the DIECI Assistance Center to agree the actions to be taken.

If routine or extraordinary maintenance or technical adjustment of the equipment is required, contact exclusively personnel authorized by the DIECI Assistance Center and note the service intervention on the control log.

If the equipment is tampered with, the guarantee is voided and the Manufacturer is relieved of all liability.



DANGER

Operators who note anomalies on the equipment or on the vehicle on which it is installed, and it does not conform to safety regulations must suspend use and immediately inform the Person in charge.



NOTICE

For road circulation, refer to the Use and Maintenance Manual of the vehicle on which the equipment is installed.

9.2 Equipment installation procedure

9.2.1 Dieci Plate

To properly install equipment carry out the following operations (fig. 150507-1):

1. Remove the safety pin "1" (if installed) by removing the safety pins "2" and lifting the locking pins "3".
2. Place the equipment on a flat not yielding surface, to be able to smoothly engage it with the tool holder plate of the vehicle.
3. Place the vehicle with the boom lowered parallel to the tool. Approach the tool holder plate to the accessory retracting the telescopic boom. The vehicle can not extend the boom if it is completely lowered. Slightly raise the boom to be able to extend it.
4. Using the tilting movement, rotate the tool holder plate door downward. Bring the top of the plate under the locking hooks of the tool.
5. Slightly lift the boom and rotate the tool holder plate upwards, thus making the equipment adhere to the tool holder plate of the vehicle. During this operation, make sure that no person is in the vicinity of the equipment or the vehicle boom.
6. Turn off the engine and get out of the vehicle.
7. Lift the lock pin "1" and insert the safety pins "3" in their seats on tool-holder plate, passing through the corresponding slots of the equipment. In the case the two holes do not match, perform the steps described in chapter "Safety pin outline"
8. Fit the safety pin "2" on the pins just inserted.
9. In the event that the equipment needs electrical or hydraulic connections, refer to the "Hydraulic hoses connection" and "Electrical cables connection" chapters.
10. Once properly fixed the equipment, turn on the vehicle and set the correct mode of operation of the vehicle related to the newly installed equipment:
11. Consult the use and maintenance manual of the vehicle to set the correct mode of use.
12. Check that in the cab there is the capacity diagram related to the vehicle and to the equipment just installed.

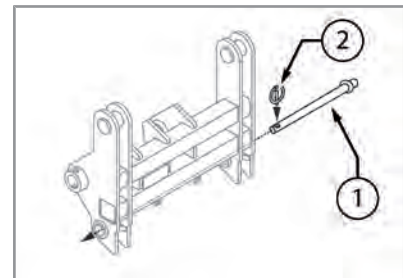

150507-1

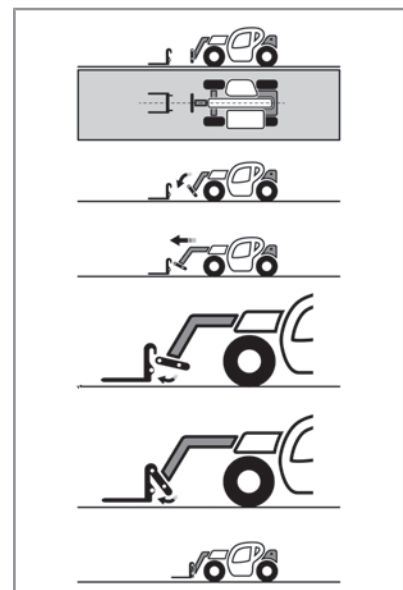

150507-2



DANGER

In case, for deformation, the pin and the related safety pin do not reach the required position, it is absolutely forbidden to use the accessory as it may come off and fall to the ground dangerously.



DANGER

It is forbidden to operate without the safety pin installed on the tool holder plate.



WARNING

When using an equipment that has electrical or hydraulic connections these must always be correctly connected to the vehicle. Failure to connect does not allow the proper operation of the safety devices with risk of damage to property and persons and risk of vehicle tipping.



DANGER

It is forbidden to operate with a mode of use of the vehicle not suitable for the type of equipment installed. The electro-hydraulic equipment will not work correctly and safety devices will not be in operation creating a risk of damage to property and people and the vehicle overturning.



DANGER

It is forbidden to operate without the proper capacity diagram related to the vehicle and to the equipment installed.

For more details on the accessory installation procedures or warnings, consult the use and maintenance manual of the accessory.



CAUTION

Before each use, check that:

- a) The equipment is properly hooked to all the pins and hooks are inserted in the correct position.
- b) There is no damage, deterioration, deformation of the equipment locking components
- c) If present, the electric cables or hydraulic hoses are in good condition and do not create hindrance while using the equipment
- d) The mode of operation of the vehicle is consistent with the type of equipment installed
- e) In the cab there are the capacity diagrams related to the vehicle and to the equipment installed.

9.2.1.1 Safety pin outline

Some equipment pieces are provided with two 2-position outlines to give the possibility to use the equipment on several models of machines.

The outlines are located on both sides of the hooks to the tool-holder plate of the machine.

To change their position, unscrew the bolts with special keys (fig. 150508-1), rotate the outlines and reassemble tightening the bolts with the appropriate tightening torque (see the vehicle use and maintenance manual).

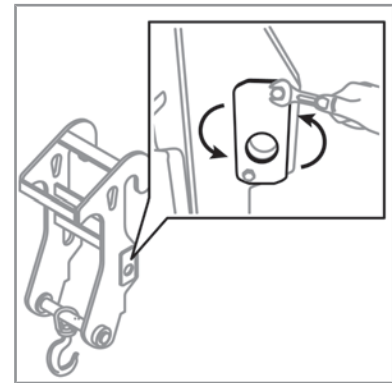

150508-1



DANGER

If the outlines are not present on the accessory, the pins of the tool-holder plate have no points of engagement with this and consequently the tool could raise and fall at any time, with danger of load falling, risk of damage to objects and persons, risk of tipping or sudden loss of stability of the vehicle.

It is mandatory to always work with the outlines in the correct position and tightened to the correct torque.

9.2.2 "ISO" type plate

"ISO" type plate manual use

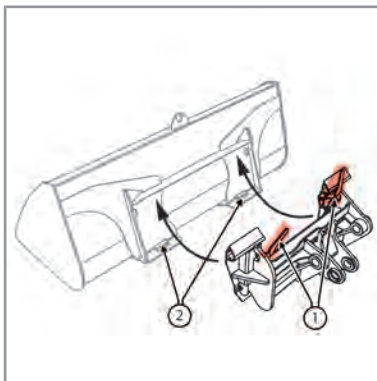

150660-1

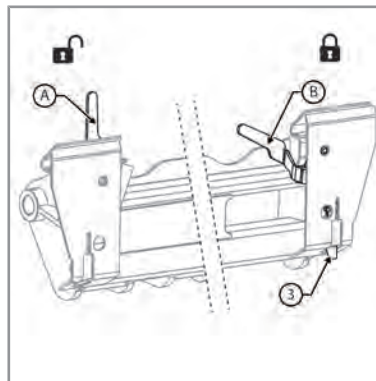

150660-2

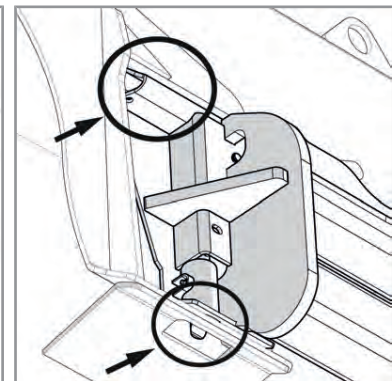

150660-3

To properly install the equipment on the "ISO" type plate it is necessary (fig. 150660-1, fig. 150660-2 and fig. 150660-3) to:

- Bring the two levers "1" in the open position "A".
- Place the equipment on a flat not yielding surface, to be able to smoothly engage it with the tool holder plate of the vehicle.
- Place the vehicle with the boom lowered parallel and central to the tool. Approach the tool holder plate to the accessory retracting the telescopic boom. The vehicle can not extend the boom if it is completely lowered. Slightly raise the boom to be able to extend it.
- Using the tilting movement, rotate the tool holder plate door downward. Bring the top of the plate under the locking hooks of the tool.

- Slightly lift the boom and rotate the tool holder plate upwards, making the equipment adhere to the tool holder plate of the vehicle. During this operation, make sure that no person is in the vicinity of the equipment or the vehicle boom.
- Turn off the engine and get out of the vehicle.
- Fasten the equipment fully lowering the levers "1" in the closed position "B".
- Check that the lock cylinders "3" are properly secured in their seats on the equipment "2".
- In the event that the equipment needs electrical or hydraulic connections, refer to the chapters "Hydraulic connections [▶ 149]" and "Electrical Connections [▶ 155]".
- Once properly fixed the equipment, turn on the vehicle and set the correct mode of operation of the vehicle related to the newly installed equipment:
- Consult the use and maintenance manual of the vehicle to set the correct mode of use.
- Check that in the cab there is the capacity diagram related to the vehicle and to the equipment just installed.



DANGER

Do not operate without having properly secured the equipment to the plate, danger of load and equipment falling.

Do not operate until both lock cylinders "3" are properly locked.

Use of "ISO" type plate with quick coupling

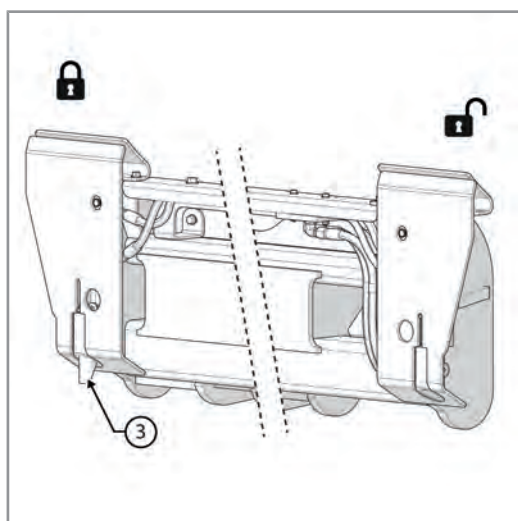

150665-4

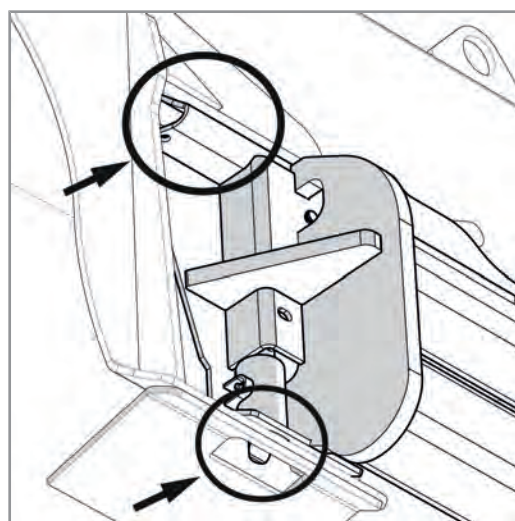

150665-5

To properly install the equipment on the "ISO" type plate with quick coupling it is necessary (fig. 150660-4 and fig150660-5) to:

- Place the equipment on a flat not yielding surface, to be able to smoothly engage it with the tool holder plate of the vehicle.
- Refer to the manual of the vehicle in the chapter related to the use of the quick coupling to open the lock cylinders "3".
- Place the vehicle with the boom lowered parallel and central to the tool. Approach the tool holder plate to the accessory retracting the telescopic boom. The vehicle can not extend the boom if it is completely lowered. Slightly raise the boom to be able to extend it.
- Using the tilting movement, rotate the tool holder plate door downward. Bring the top of the plate under the locking hooks of the tool.

- Slightly lift the boom and rotate the tool holder plate upwards, making the equipment adhere to the tool holder plate of the vehicle. During this operation, make sure that no person is in the vicinity of the equipment or the vehicle boom.
- Refer to the manual of the vehicle in the chapter related to the use of the quick coupling to close the lock cylinders "3".
- Check that the lock cylinders "3" are properly secured in their seats on the equipment "2".
- In the event that the equipment needs electrical or hydraulic connections, switch off the vehicle and refer to the chapters "Hydraulic connections [▶ 149]" and "Electrical Connections [▶ 155]".
- Once properly fixed the equipment set the correct mode of operation of the vehicle related to the newly installed equipment:
- Check that in the cab there is the capacity diagram related to the vehicle and to the equipment just installed.



DANGER

Do not operate without having properly secured the equipment to the plate, danger of load and equipment falling.

Do not operate until both lock cylinders "3" are properly locked.

9.3 Hydraulic connections

9.3.1 Warnings for hydraulic connections



NOTICE

Before making the hydraulic connections, perform the "Equipment installation procedure" and check the equipment is correctly fixed to the vehicle.

Check the hydraulic tubes do not obstruct the movements of the vehicle or of the equipment as it may be damaged.

Consult the equipment manual to verify correct operation.



WARNING

When using an equipment that has electrical or hydraulic connections these must always be correctly connected to the machine. Failure to connect does not allow the proper operation of the safety devices with risk of damage to property and persons and risk of machine tipping.



NOTICE

Always accurately clean the hydraulic connections before each coupling. If not used, both the hydraulic connections must be protected with adequate plastic caps.



WARNING

Do not use the vehicle or the equipment if the hydraulic tubes are worn or damaged, but repair or replace them.



WARNING

Once the hydraulic connections have been made, it is compulsory to verify that the controls are consistent with the operations carried out on the vehicle.

By inverting the connections, the accessory functions may be inverted compared to normal use, therefore, after having completed the equipment installation procedure, test the various functions in a free zone.



DANGER

Hydraulic liquid under pressure

Fine jets of hydraulic oil at high pressure can penetrate the epidermis. Keep hands and face at a safe distance from the pressurized fluid and wear goggles and protective gloves. Bring a piece of cardboard to the area of the suspected leak and then check for traces of liquid on the cardboard. If the liquid penetrates the skin immediately seek for medical advice.



DANGER

Hydraulic pressure

The leakage of hydraulic oil at operating pressure can cause injury: before connecting or disconnecting the hydraulic hoses, release the residual pressure from the hydraulic circuit. Prevent starting the engine with disconnected hoses.

9.3.2 Type of hydraulic quick couplings

The hydraulic quick couplings at boom head can be of two types:

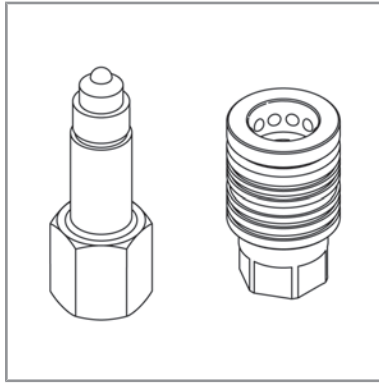

Push-Pull (fig. 150509-1)

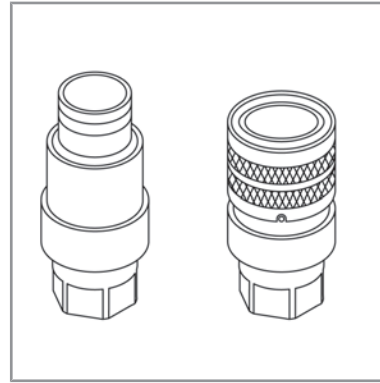

Flat-Face (fig. 150509-2)

9.3.3 References for correct connection

To make the correct connection of the hydraulic fittings, each hydraulic plug or socket is marked with a color or symbol.

- The **red** plugs must be connected to the **red** sockets or those with the “+” mark.
- The **blue** plugs must be connected to the **blue** sockets or those with the “-” mark.

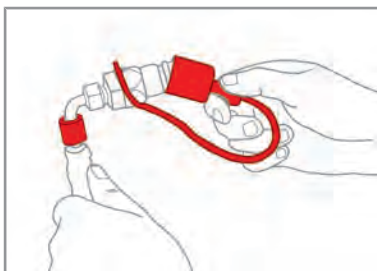

Cap and mark on the hydraulic sockets.



Hydraulic sockets on the boom head

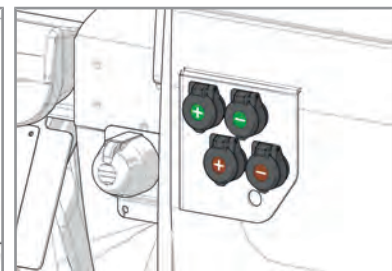

Rear hydraulic sockets (if present).



WARNING

Equipment with hydraulic connections made incorrectly have movements or functions that do not agree with the operator's controls and can cause damage to other operators, material handled or to the vehicle and equipment.

Always make sure that the hydraulic connections follow the indications given above for proper connection and that the movements and functions of the equipment comply with the operator controls.

9.3.4 Push-Pull couplings connection

To connect the Push-Pull quick couplings to the sockets on the boom head:

1. Perform the equipment installation procedures described in the chapter: "Equipment installation procedure".
2. Turn off the vehicle.
3. In case of closed center distributor, discharge the system residue pressure (refer to chapter **Closed center distributor: Relieve the pressure through the trailer Descent button** [▶ 154]).
4. Remove the protective cap from the equipment hydraulic plugs (fig. 150510-1).
5. Lift the protective cover for the hydraulic socket present on the boom head (fig. 150510-2).
6. Clean the plug and socket, if soiled.
7. Fit the plug inside the socket and press until the tube is blocked (fig. 150510-3).
8. Check that the hydraulic tube is correctly fixed.
9. Carry out the same operation for both tubes.

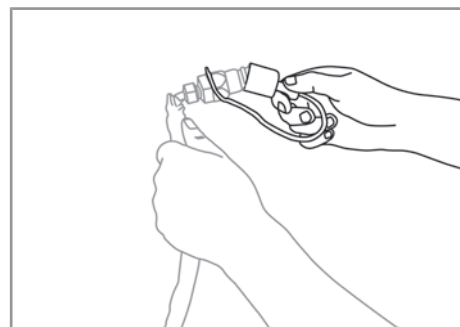

150510-1

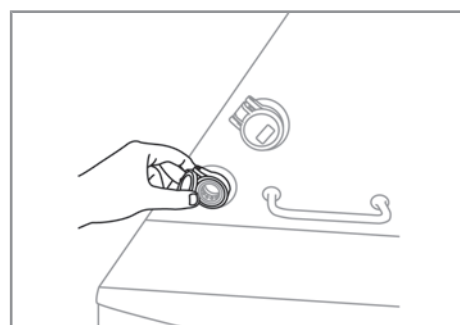

150510-2

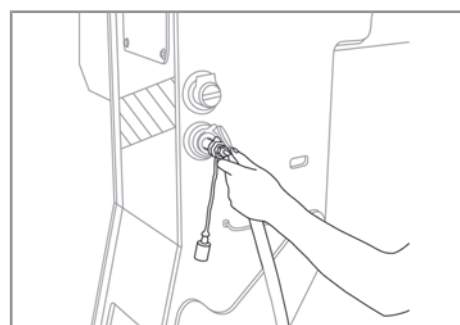

150510-3



NOTICE

Consult the equipment manual to verify correct operation.

9.3.4.1 Push-Pull couplings connection when connected to a valve

To connect the Push-Pull quick couplings to the valve on the boom head:

1. Perform the equipment installation procedures described in the chapter: "Equipment installation procedure".
2. Turn off the vehicle.
3. In case of closed center distributor, discharge the system residue pressure (refer to chapter **Closed center distributor: Relieve the pressure through the trailer Descent button** [▶ 154]).
4. Remove the protective cap from the equipment hydraulic plugs (fig. 150511-1).
5. Remove the protective cap from the hydraulic sockets installed in the valve on the boom head (fig. 150511-2).
6. Clean the plug and socket, if soiled
7. Push the ring on the valve socket towards the boom (fig. 150511-3).
8. Place the plug fully inside the socket and release the ring of the valve (fig.150511-4).
9. Check the hydraulic tube is correctly fixed
10. Carry out the same operation for both hoses

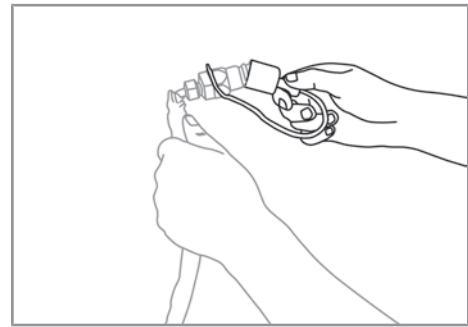

150511-1

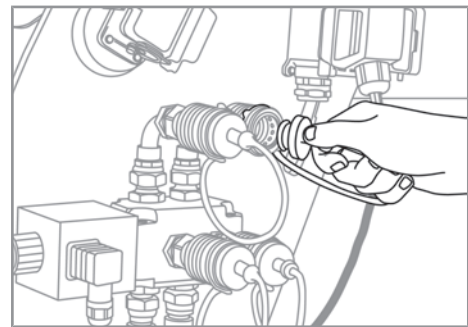

150511-2

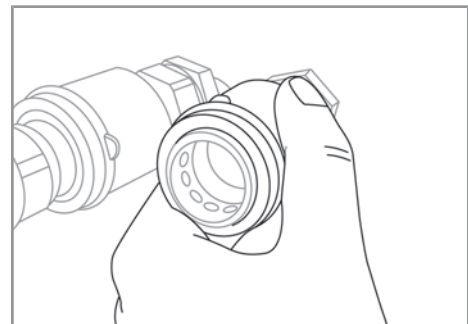

150511-3

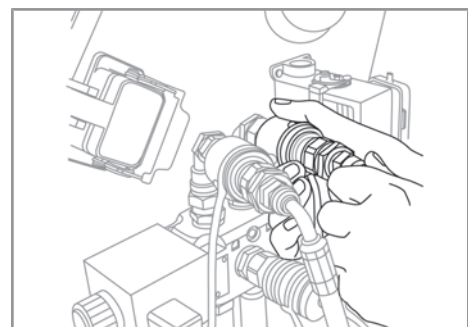

150511-4



NOTICE

Consult the equipment manual to verify correct operation.

9.3.5 Flat-Face couplings connection

To connect the Flat-Face quick couplings:

1. Perform the equipment installation procedures described in the chapter: "Equipment installation procedure".
2. Turn off the vehicle.
3. In case of closed center distributor, discharge the system residue pressure (refer to chapter **Closed center distributor: Relieve the pressure through the trailer Descent button** [▶ 154]).
4. Clean the plug and socket, if soiled
5. Rest the plug at center of the socket and push the fully plug (fig. 150512-2), until the socket ring is lifted
6. Turn the ring to block the plug inside the socket (fig. 150512-3).
7. Check the hydraulic tube is correctly fixed
8. Carry out the same operation for both hoses

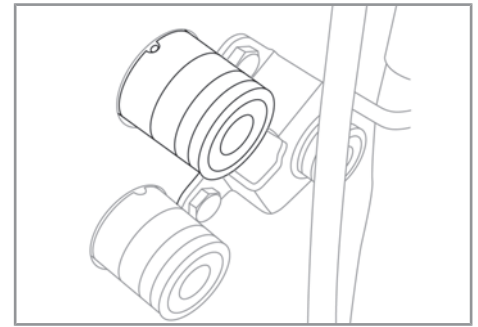

150512-1

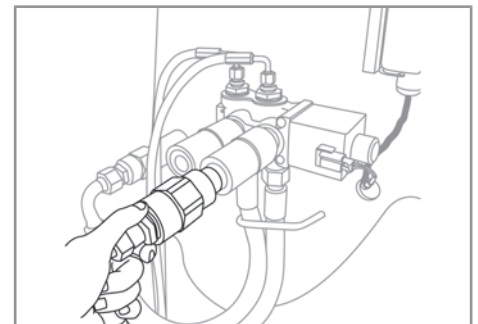

150512-2

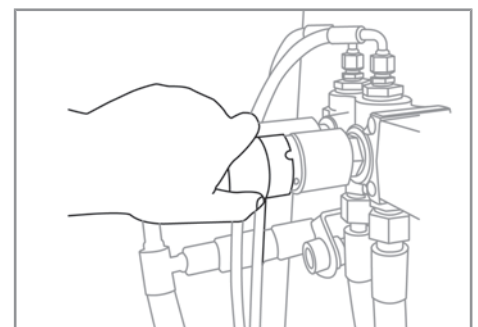

150512-3



NOTICE

Consult the equipment manual to verify correct operation.

9.3.6 Closed center distributor: Relieve the pressure through the trailer Descent button

In case a closed center hydraulic distributor is installed on the vehicle and the is present and the "Trailer descent" button is present:

1. Move the ignition key of the vehicle to position "I" (fig. 150501-2).
2. Select the hydraulic socket still under pressure (refer to the vehicle manual, chapter "Hydraulic sockets selection").
3. Press the "Trailer descent" button (fig. 150501-2) to release the residual pressure of the selected hydraulic press.
4. Proceed with the hydraulic couplers connection operation.

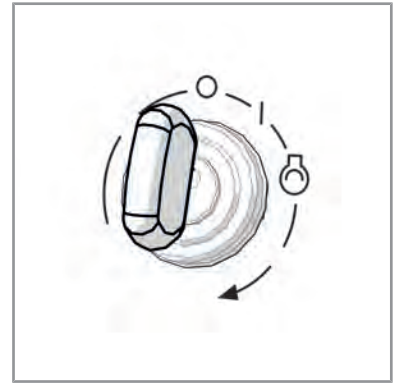

150501-1

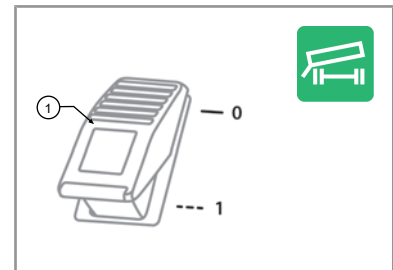

150501-2

9.4 Electrical Connections

9.4.1 Warnings for electrical connections



DANGER

Before making the electrical connections, switch off the vehicle.

Do not use the vehicle or the equipment if the electrical cables are worn or damaged, but repair or replace them.



WARNING

Do not leave the boom plug hanging from the chain during work operations as this may be damaged impairing the vehicle correct operation when used without equipment.



CAUTION

Before making the electrical connection, perform the "Equipment installation procedure" and check the equipment is correctly fixed to the vehicle.



WARNING

When using an equipment that has electrical or hydraulic connections these must always be correctly connected to the vehicle. Failure to connect does not allow the proper operation of the safety devices with risk of damage to property and persons and risk of vehicle tipping.

Consult the equipment manual to verify correct operation.



CAUTION

Check that the power cable is not in a position that hampers the movements of the operating vehicle and of the equipment as it could be damaged.

9.4.2 Procedure for connecting electrical connections

The electrical connections on the boom head may be at 6 or 24-pole, but the connection procedure is the same for both.

For equipment provided with electrical system carry out the following operations:

- Perform the equipment installation procedures previously described:
- Turn off the vehicle.
- Disconnect the cover from the socket on the boom "1" (fig. 150512-1) lowering the 2 safety levers "2".
- Remove the cover located on the boom socket and fit it in the dummy socket aside (fig. 150512-2) and fasten it with the appropriate levers.

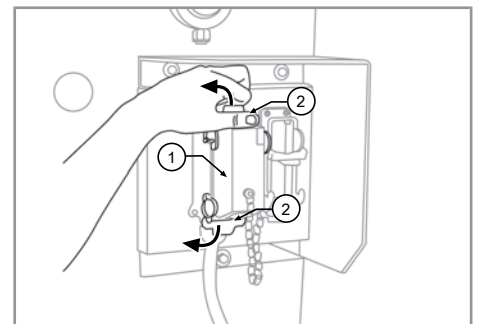

150512-1

- Disconnect the plug from the dummy socket on the equipment "1" (fig. 150512-3) lowering the 2 safety levers "2" (fig. 150512-3).
- Connect the plug of the equipment on the electrical socket of the boom, fastening it by lifting the 2 safety levers "1" (fig. 150512-4).
- Once the equipment is properly fixed, turn on the vehicle and set the correct mode of operation of the vehicle related to the newly installed equipment. See the "Equipment selection and operating mode" chapter on the use and maintenance manual of the vehicle.
- Check that in the cab there is the capacity diagram related to the vehicle and to the equipment just installed.

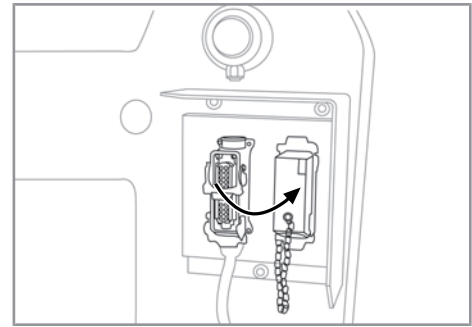

150512-2

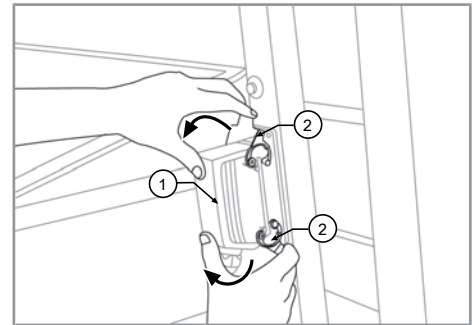

150512-3

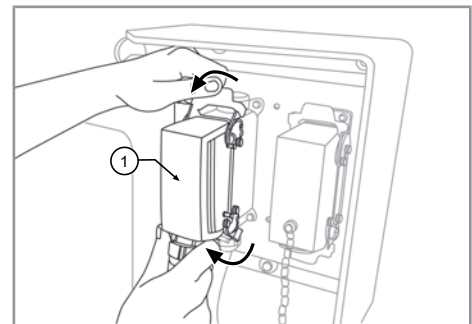

150512-4

9.5 Equipment removal

To store the accessory, once you finished using it, carry out the following operations:

1. Place the machine on a solid and level ground
2. Position the equipment above a support platform to facilitate the handling and transportation of the single piece of equipment.
3. Lower and extend the vehicle boom of about one meter.
4. Turn off the engine.
5. Remove the electrical connections, if any (see the following chapter)
6. Remove the water connections, if any (see the following chapter)
7. Release the equipment following the reverse procedure of the equipment installation in accordance with the type of plate installed on the vehicle.
8. Turn on the vehicle and swing down in order to release the tool-holder plate from the equipment.
9. Once released the tool-holder plate, retract the machine boom.

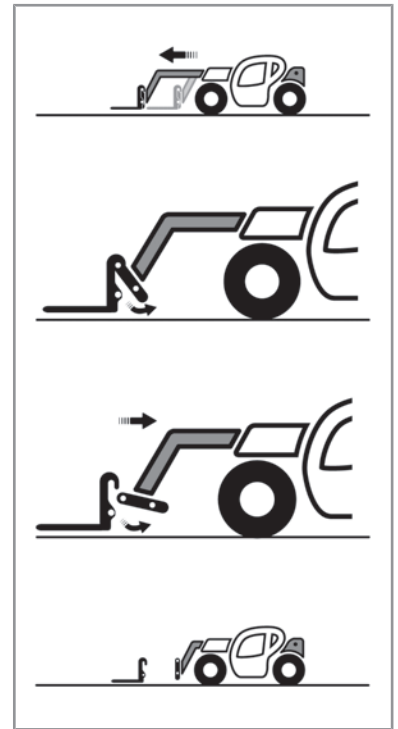

150604-1



NOTICE

The accessory placed on the ground must always be appropriately marked and barriers and clearances must be laid on all sides of the area that it could occupy falling.



DANGER

After releasing the system pressure always wait for a minute before disconnecting the couplings.

Always disconnect the hydraulic hoses of the tool before releasing it from the vehicle. Otherwise it is possible to damage the pipes or cables and the tool may fall and be dragged.

9.5.1 Electrical connections removal

To remove the electrical connections from the equipment it is necessary to:

1. Follow steps 1, 2, 3 and 4 of the procedure to remove the equipment from the vehicle described in the previous chapter.
2. Disconnect the plug of the equipment from the boom lowering the two safety levers (fig. 150514-1)
3. Position the plug of the equipment on its dummy socket "1" (fig. 150514-2), fastening it with the safety levers "2".
4. Disconnect the cover located on the boom dummy socket and fit it in the electrical socket (fig. 150514-3)

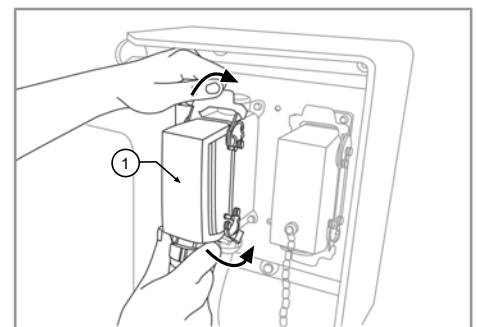

150514-1

5. Secure the cover to the socket on the boom "1" (fig. 150514-4) through the safety levers (fig. 150514-4)
6. Check that the electrical cables are not trapped in the tool-holder plate or that they can be crushed by the equipment when it will be placed on the floor.
7. Proceed with the subsequent operations to remove the equipment from the vehicle

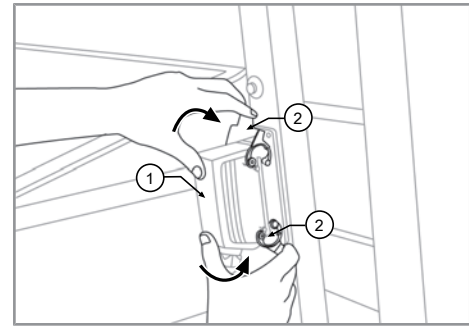

150514-2

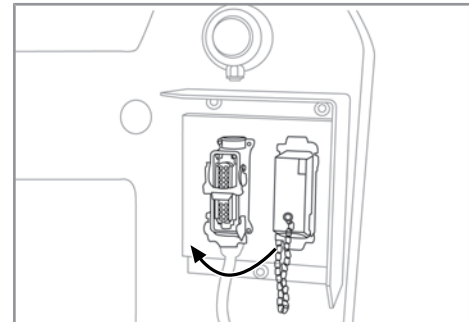

150514-3

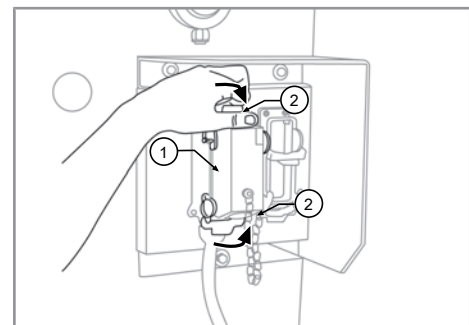

150514-4

9.5.2 Push-Pull couplings removal

To disconnect the Push-Pull quick couplings from the socket on the boom head it is necessary to:

1. Follow steps 1, 2, 3 and 4 of the procedure to remove the equipment from the vehicle described in the previous chapter
2. If a closed center distributor is installed on the vehicle, carry out the procedures described in the "Hydraulic hoses connections" chapter to release pressure in the hydraulic circuit
3. Turn off the vehicle
4. Pull the plug towards yourself to remove it from the socket (Fig. 5-I0400)
5. Clean the plug and socket, if soiled
6. Fit the protective cap on the equipment hydraulic plugs (Fig. 6-I0400)

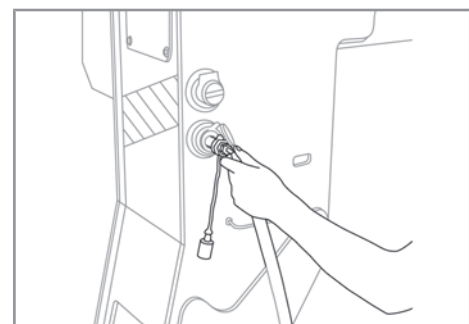

150513-1

7. Carry out the same operation for both hoses
8. Check that the hydraulic hoses are not trapped in the tool-holder plate or that they can be crushed by the equipment when it will be placed on the floor
9. Proceed with the subsequent operations to remove the equipment from the vehicle

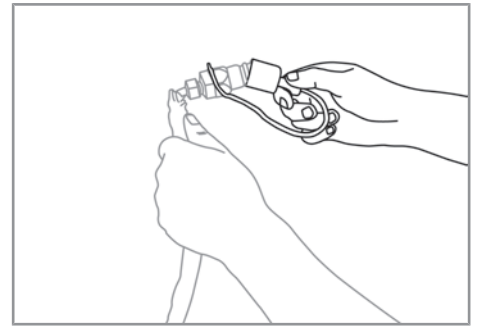

150513-2

9.5.2.1 Push-Pull couplings removal when connected to a valve

To disconnect the Push-Pull quick couplings from the valve on the boom head:

1. Follow steps 1, 2, 3 and 4 of the procedure to remove the equipment from the vehicle described in the previous chapter.
2. If a closed center distributor is installed on the vehicle, perform the procedures described in the "Hydraulic hoses connections" chapter to release pressure in the hydraulic circuit.
3. Turn off the vehicle.
4. Push the ring of the socket towards the vehicle boom "1" (fig. 150515-1).
5. Pull the plug towards yourself to remove it from the socket "2".
6. Clean the plug and socket, if soiled
7. Fit the protective cap to the equipment hydraulic plugs (fig. 150515-2).
8. Fit the protective cap to the hydraulic sockets of the valve (fig. 150515-3).
9. Carry out the same operation for both tubes.
10. Check that the hydraulic hoses are not trapped in the tool-holder plate or that they can be crushed by the equipment when it will be placed on the floor.
11. Proceed with the subsequent operations to remove the equipment from the vehicle.

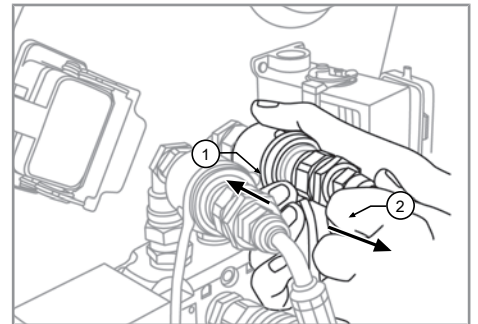

150515-1

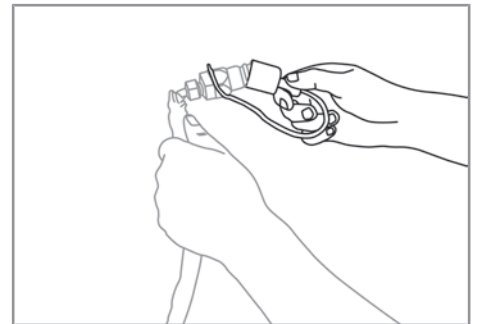

150515-2

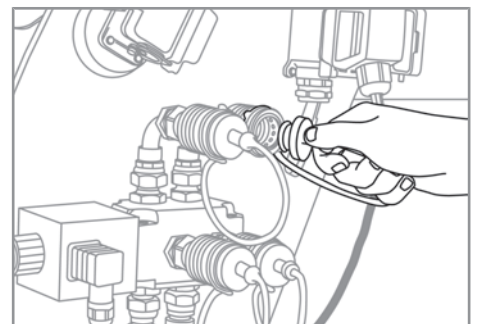

150515-3

9.5.3 Flat-Face couplings removal

To disconnect the Flat-Face quick couplings:

1. Follow steps 1, 2, 3 and 4 of the procedure to remove the equipment from the vehicle described in the previous chapter.
2. If a closed center distributor is installed on the vehicle, perform the procedures described in the "Hydraulic hoses connections" chapter to release pressure in the hydraulic circuit.
3. Turn off the vehicle.
4. Turn the socket ring to match the recess with the position of the ball placed on the socket (fig. 150516-1).
5. Push the socket ring "1" (fig. 150516-2).
6. Pull off the plug "2" (fig. 150516-2)
7. Clean the plug and socket, if soiled.
8. Carry out the same operation for both tubes.
9. Check that the hydraulic hoses are not trapped in the tool-holder plate or that they can be crushed by the equipment when it will be placed on the floor.
10. Proceed with the subsequent operations to remove the equipment from the vehicle.

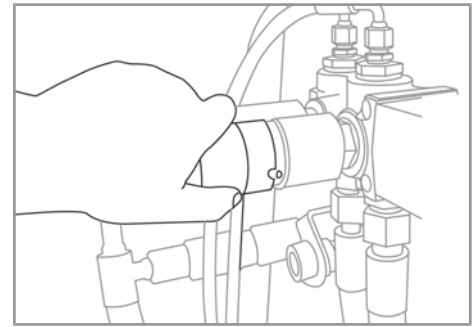

150516-1

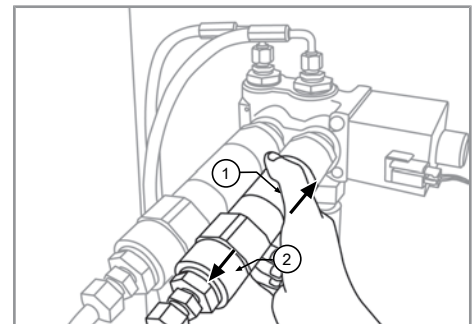

150516-2

9.6 Forks

9.6.1 Identification

The term "Fork" means the pair of forks to be installed on the vehicle.

The purpose of this equipment is the lifting and handling of a load from the ground upwards, and vice versa.



NOTICE

The forks may be provided with a spreader/shifter that allows to position the distance between the forks more quickly and safely.

The data necessary for the identification of the forks are positioned on the right side of the forks, in the upper part "A" (fig. 150518-1).

Below are the identification data (their order may be different on the forks).

To ensure a prompt and efficient service when ordering parts or when requesting information or technical clarification always specify the identification details.

Therefore we recommend to note the data relating to the accessory in your possession in order to safely and quickly identify them in the future, in case of need.

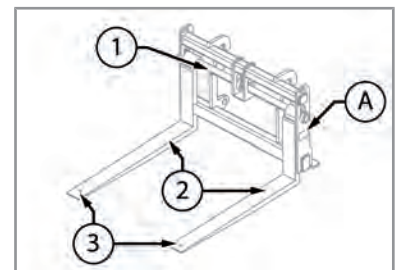

150518-1

Dieci forks code
Manufacturer's Logo/ Abbreviation
Manufacture Date/Batch
Maximum capacity (Kg)
Load application center of gravity (mm) *

* There may be more than one value depending on the load.

9.6.2 Description

The forks (fig. 150519-1) consist of the following main components:

1. Forks
2. Eyelet
3. Equipment fastening hole

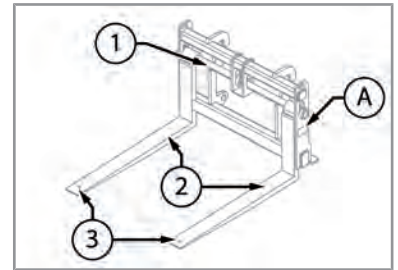

150519-1



WARNING

The equipment fastening hole located at the forks end can only be used for fastening certain equipment to the forks. For the fastening procedures refer to the manual of the equipment.

9.6.3 Forks check



NOTICE

For the forks verification frequency refer to the "Control log".



CAUTION

During maintenance and control, it is mandatory to use the appropriate Personal Protective Equipment.



WARNING

It is absolutely forbidden to carry out maintenance on the forks (e.g. welding, drilling, engraving, etc ...).

In the event of damage or deformation immediately replace the forks.

Check the forks thickness.

The maximum wear allowed is **10%** (fig. 150520-1).

For example for a fork 70 mm thick, the thickness must not be less than 63 mm. ($70 - 10\% = 63$)

For a quick check of the thickness of the forks, it is necessary to measure the thickness in the vertical part of the fork "1" (fig. 150520-2); this will be the dimension to which refer for the fork thickness measurements "2" (fig. 150520-2). Make at least three measurements at several points.

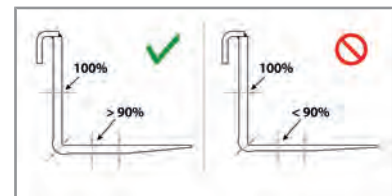

150520-1

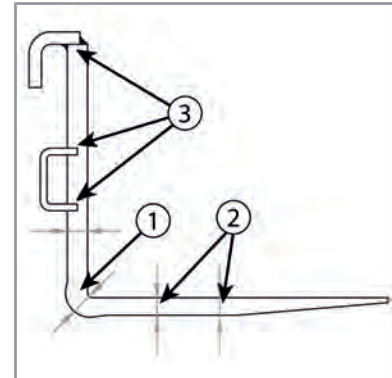

150520-2

Verify the deformation of the forks

Verify that the two forks are parallel between them and that the distance from the ground is the same for both, or with difference of less than **3%** of the length of the fork (fig. 150520-3).

For example, for a fork 1800 mm long, the difference between the maximum permissible deformation of the fork tips will therefore be of 54 mm ($1800 \times 3/100 = 54$).

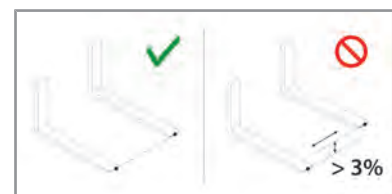

150520-3

Check the integrity of the welds

Check that all the welds on the forks "3" (fig. 150520-4) are in good conditions and have no cracks or anomalies.

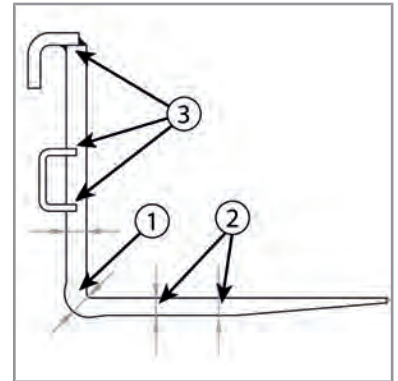

150520-4

9.6.4 Forks use



CAUTION

Before starting to use the equipment, inspect and test it as described in the section "Equipment pre-use check".



WARNING

It is absolutely forbidden to use the forks or any type of equipment, without securing it to the tool holder plate with the appropriate safety pins.



DANGER

Before each use, check the wear status of the forks, they could be worn out and not hold the load to be handled creating a dangerous situation.

Before starting to use the equipment, refer to the chapters:

- a) "Safety regulations"
- b) "Safe working procedures"
- c) "Forks check"

To use the forks it is sufficient to move the controls for the plate tilting.

By moving the joystick to the left, the tips of the forks will rise; by moving the joystick to the right, the tips of the forks will drop.

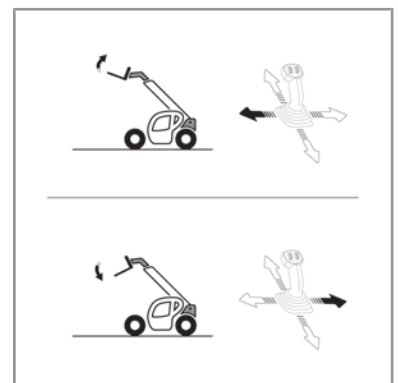

150521-1

9.6.5 Forks adjustment

To adjust the position of the forks it is necessary to:

- Deposit a load to the ground.
- Lower and fully retract the boom moving the forks to about 1 m above the ground.
- Turn off the vehicle.
- Get off the vehicle and manually move the forks to the desired width.

9.6.6 Fork extensions



CAUTION

Before starting to use the equipment, inspect and test it as described in the section "Forks Safe Working Procedures".

Before starting to use the equipment, refer to the "Safety regulations" and "Safe Working Procedures" described in the manual of the machine on which the equipment is installed.

The fork extensions consists of the following main components (fig. 150521-1):

1. Extension
2. Fastener pin
3. Safety plug

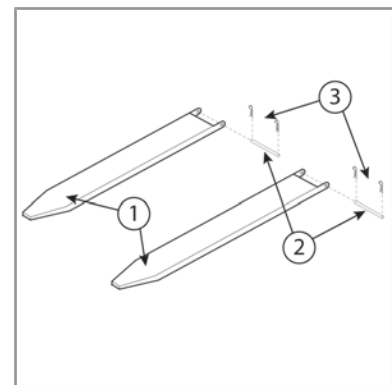

150521-1

Warnings for use

- Use the extensions only with the forks for which they were constructed.
- Before use, check their integrity.
- Always apply the pin with the related split pin.
- Do not use loads exceeding those indicated by the forks on which the fork extensions are mounted.
- Refer to the capacity diagram of the forks to which are applied the extension forks.
- Make sure of the load stability.
- Do not take the load with a single extension.
- Do not use extensions for purposes other than those for which they were constructed.

Installation

- Fit the extension on the forks after establishing the integrity of the extension and the forks.
- Put the fastener pin "2" with the related safety pin "3".



DANGER

Never use if the forks or the extensions if they are defective or show tampering signs.

Forks extension check

- At each use check the integrity of welds and repair if necessary.

- When the thickness of the lower sheet reaches 80% of its original thickness, the extension must be replaced.

9.6.7 Forks safe working procedures

9.6.7.1 General instructions on forks use



DANGER

Never lift a load slung with a single fork or with a board.

It is absolutely forbidden to use the forks with hooks, straps or other materials for handling suspended loads. Use the appropriate accessories (hook, winch, jib).

- Always set the forks fully under the load and move it to the transport position (forks at 300mm from the ground and tilted backwards, with fully retracted boom).
- Always set the forks fully under the load and move it to the transport position (forks at 300mm from the ground and tilted backwards, with fully retracted boom).
- The load diagrams are valid for centers of gravity indicated on the diagram. For a center of gravity at a greater distance, contact your dealer.
- Pay attention to the risk of crushing limbs when adjusting the forks manually.
- It is absolutely forbidden to increase the length or width of the forks with extensions not provided directly by the Manufacturer. In this case DIECI is held harmless from any liability arising from their use.
- Forks overloading and transverse stress are strictly prohibited.
- Place the forks to their maximum possible width. Before lifting a load make sure that the width of the forks corresponds to that of the pallet or that these can withstand the weight of the load on the pallet. Forks set wide apart maintain a stable load.
- Place loads evenly on the forks, to obtain a stable balance. When lifting wide loads, or not centered and that are impossible to center, maneuver the vehicle with caution in order to prevent this from tipping. Use caution when lifting bars of considerable length.
- Do not raise the load with the tip of the forks facing downwards. The forks must always be with the tips pointing upwards; in this way the load will lean against the plate of the forks. A lifted load can be tilted forward only if it must be placed on a stack or directly on a discharge surface.
- Do not use the machine to transport or move persons when the forks are assembled on it. Use suitable accessories.

9.6.7.2 Load transport position with forks

To correctly transport a load with forks it is necessary to:

- Fully retract the boom.
- Lower the boom fully down so that the forks are at about 300 mm from the ground.
- Tilt the fork tips upward.

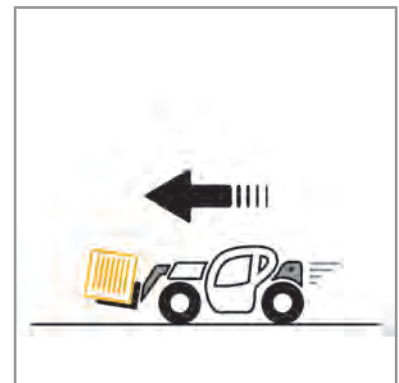

150527-1

9.6.7.3 Picking up a load from the ground

1. Slowly move the machine to the load to be lifted with the boom fully retracted and the forks in a horizontal position at the height of the lifting position. Keep the forks raised just enough to avoid contact with the ground.
2. Bring the forks under the load to be lifted up to the contact with the tool holder plate.
3. Press the brake pedal and move the gear selector in neutral.
4. Slightly lift the load and tilt the tool holder plate backward setting it in the transport position.

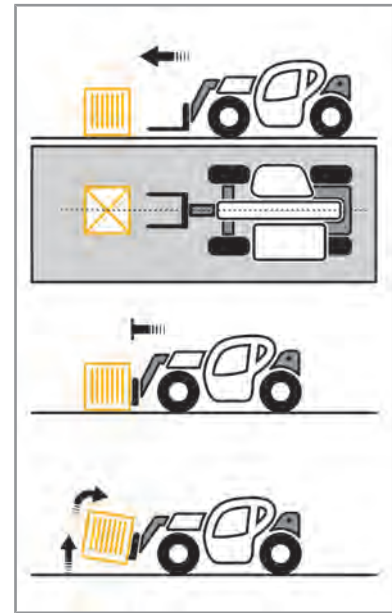

150528-1



CAUTION

Always observe the center of gravity of the load, tilt the forks enough to ensure stability and prevent the loss of the load during braking.



DANGER

Never carry a load with boom raised and/or removed.

9.6.7.4 Picking up a load from a high position

1. Make sure that the forks pass easily under the load.
2. Drive slowly and cautiously approaching the vehicle to the load placing it perpendicular to this with the forks horizontal. If necessary, use the inching pedal to approach slowly.
3. Always remember to keep the distance required to insert the forks under the load, between the stack and the machine.
4. Extend the boom for the shortest possible length.
5. After bringing the forks under the load to be lifted until it is in contact with the fork carrier plate, press the brake pedal and move the gear selector in neutral.
6. Lift the load and tilt the fork carrier plate to the transport position.
7. If possible lower the load without moving the vehicle.
8. Lift the boom to move the load away, then retract the extensions and lower the boom to set the load in the transport position.
9. If not possible, move the vehicle backward very slowly and very carefully, after moving the load away properly retract the extensions and lower the boom to set the load in the transport position.

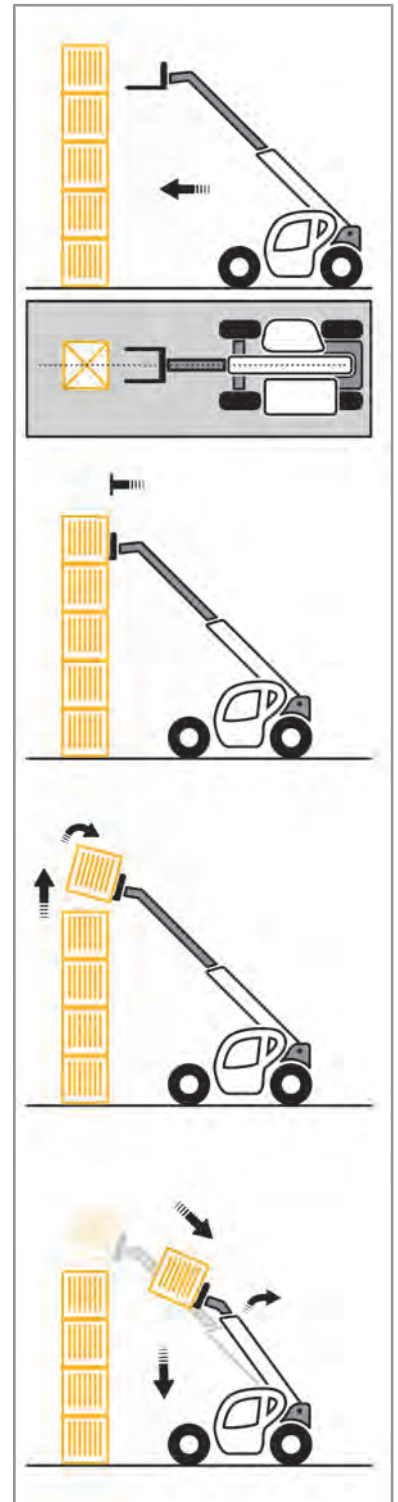

150529-1

**CAUTION**

Always observe the center of gravity of the load, tilt the forks enough to ensure stability and prevent the loss of the load during braking.

**DANGER****Danger of tipping**

It is absolutely forbidden to pick up a load if the machine is not level.

Never carry a load with boom raised and/or removed.

9.6.7.5 Positioning a load in a high position

1. Bring the load in the transport position in front of the stack.
2. Lift and extend the boom to take the load above the stack. If necessary, move the machine towards the stack very slowly and very carefully. If necessary, use the inching pedal to approach slowly.
3. Press the brake pedal and move the gear selector in neutral.
4. Place the load horizontally and lay it on the stack, lower and retract the extensions to properly position the load.
5. Release the forks alternately retracting the extensions and lifting the boom; if possible make the vehicle move back very slowly and very carefully.

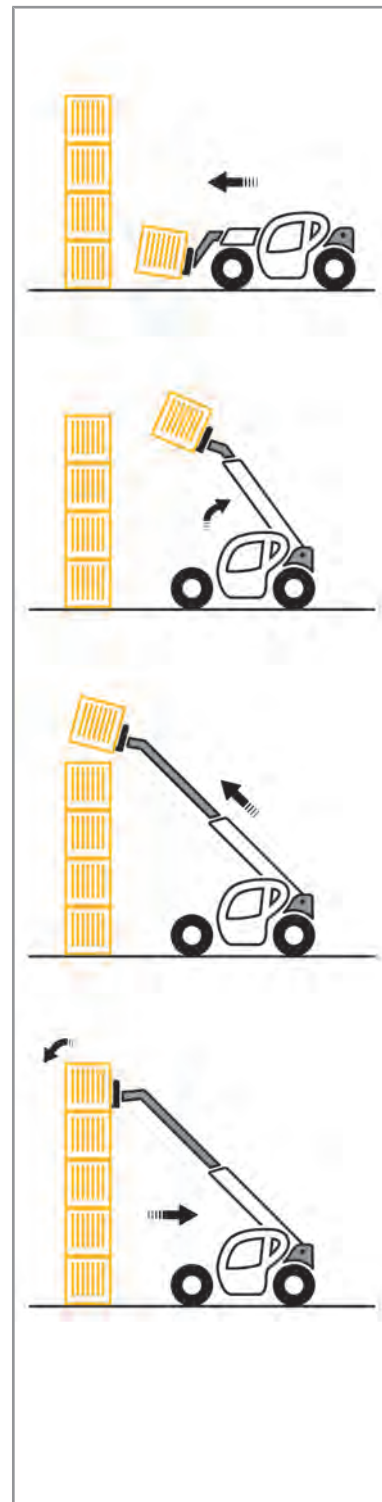

150530-1

**CAUTION**

Always observe the center of gravity of the load, tilt the forks enough to ensure stability and prevent the loss of the load during braking.

**DANGER****Danger of tipping**

It is absolutely forbidden to pick up a load if the machine is not level.

Never carry a load with boom raised and/or removed.

9.6.7.6 Picking up a round load

1. Tilt the forks forward and retract the telescopic boom, while inserting the forks under the load
2. rotate the fork carrier plate back to slide the load. If necessary secure the load with wedges.

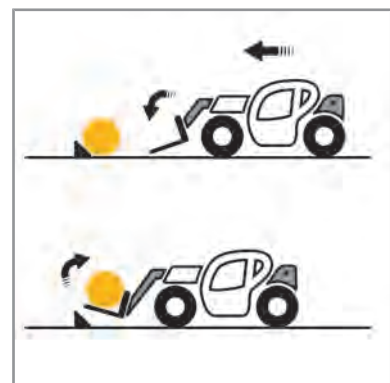

150531-1

**CAUTION**

Always observe the center of gravity of the load, tilt the forks enough to ensure stability and prevent the loss of the load during braking.

**DANGER**

Never carry a load with boom raised and/or removed.

**NOTICE**

There are various accessories such as clamps to facilitate the work with objects which are round, contact your DIECI dealer.

9.7 Fork shifter



NOTICE

The Fork shifter is an optional equipment.

9.7.1 Fork shifter installation

The equipment in question allows to laterally move the forks installed on it.

The data necessary for the identification are positioned on the right side of the equipment, in the upper part "A" (fig. 150553-1).

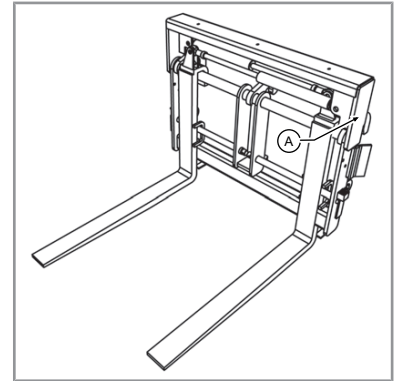

150553-1

Below are the identification data (their order may be different on the forks).

- 1- Model
 - 2 - Serial number
 - 3 - Year of manufacture
 - 4 - Mass (Kg)
 - 5 - Capacity (Kg)
 - 6 - Maximum hydraulic pressure (bar)
 - 7 - Center of gravity (mm)



150553-2

To ensure a prompt and efficient service when ordering parts or when requesting information or technical clarification always specify the identification details.

Therefore we recommend to note the data relating to the accessory in your possession in order to safely and quickly identify them in the future, in case of need.

9.7.2 Fork shifter description

The fork shifter (fig. 150554-1) consist of the following main components:

- 1 - Fixed base
- 2 - Forks
- 3 - Equipment fastening hole

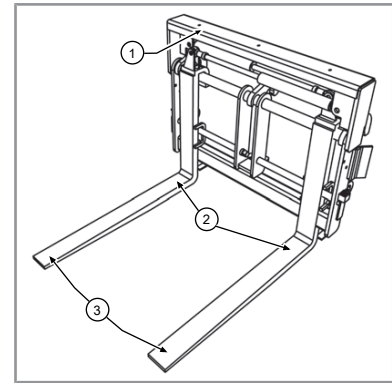

150554-1



NOTICE

The equipment fastening hole located at the forks end can only be used for fastening certain equipment to the forks. For the fastening procedures refer to the manual of the equipment.

9.7.3 Fork shifter installation



NOTICE

For the fork shifter installation, refer to the chapter "Equipment installation".

9.7.4 Fork shifter maintenance



NOTICE

For the fork spreader maintenance, refer to the chapter "Forks check".

The fork spreader requires maintenance (fig. 150555-1).

- Use only silicone oil to lubricate the chrome plated cylinders "1".
- Use grease to lubricate the rails for sliding between the fixed base and the translating support "2".

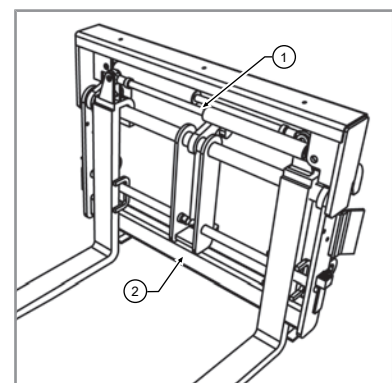

150555-1



WARNING

Do not use grease to lubricate the movable hydraulic parts or chrome plated cylinders.

Use only silicone oil and clean them frequently.

9.7.5 Fork shifter use



CAUTION

Before starting to use the equipment, inspect and test it as described in the section "Equipment pre-use check".



DANGER

Before each use, check the wear status of the forks, they could be worn out and not hold the load to be handled creating a dangerous situation.

Before starting to use the equipment, refer to the chapters:

- a) "Safety regulations"
- b) "Safe working procedures"



WARNING

Before using the fork shifter, make sure that its movements are correct.

If the joystick controls do not correspond to the correct movements of the forks, interchange the position of two hydraulic hoses on the quick connectors on the boom head.

To use the fork shifter it is necessary to select the hydraulic socket on the corresponding boom head and move the services control.

NOTICE! Refer to the joystick chapters to know the commands related to the use of the service rollers.

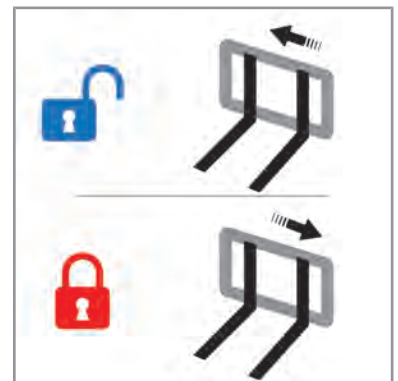

150556-1

9.7.6 Fork shifter hydraulic diagram

Hydraulic diagram legend:

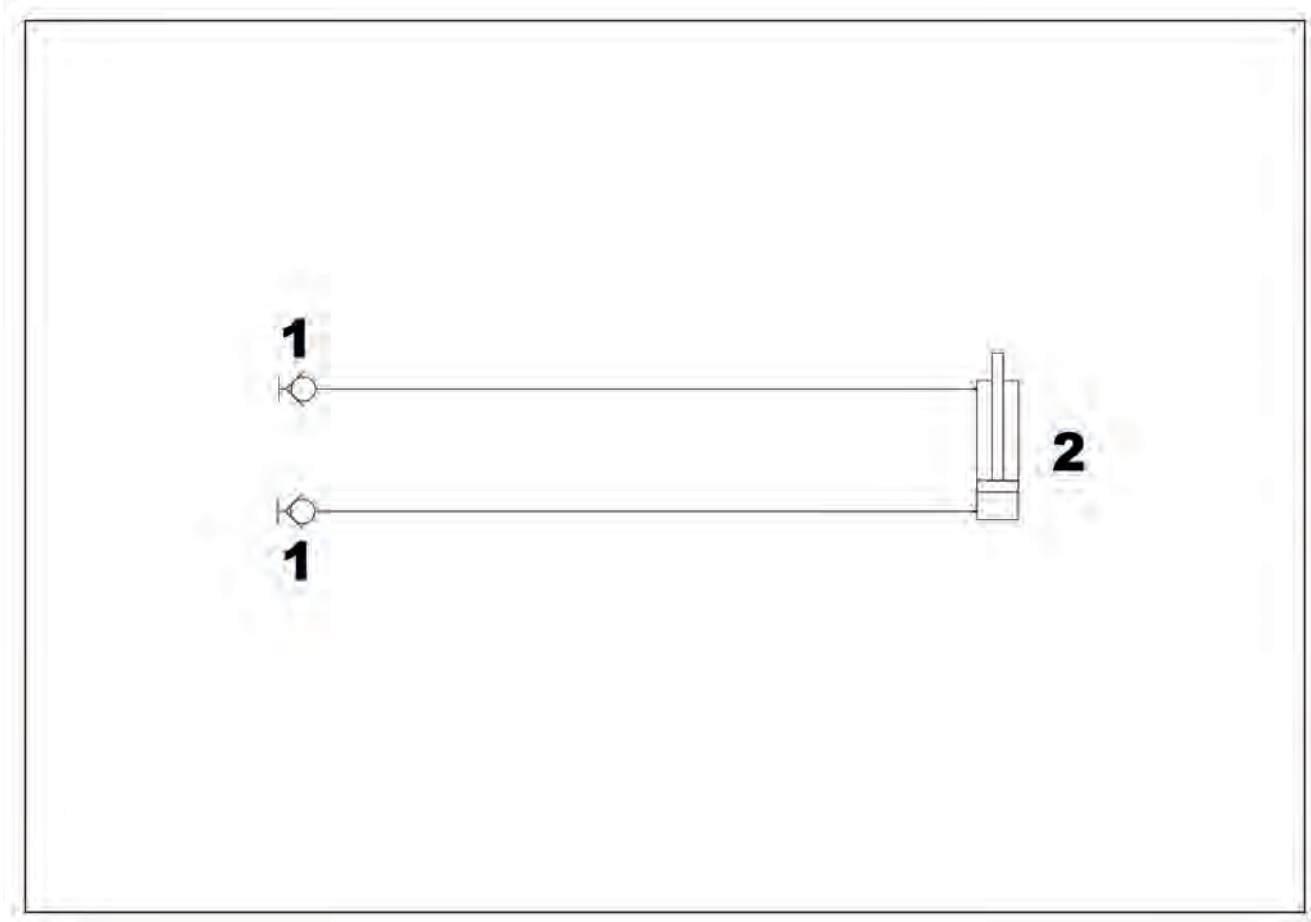

Illustration 7: 150557-1

1 Quick couplers

2 Cylinder

9.8 Bucket

9.8.1 Buckets identification

Buckets allow handling inert material.

To ensure a prompt and efficient service when ordering parts or when requesting information or technical clarification always specify the serial number.

Therefore we recommend to note the data relating to the accessory in your possession in order to safely and quickly identify them in the future, in case of need.

The data necessary for the identification of the buckets are positioned on the right side, in the upper part "A" (fig. 150522-1).

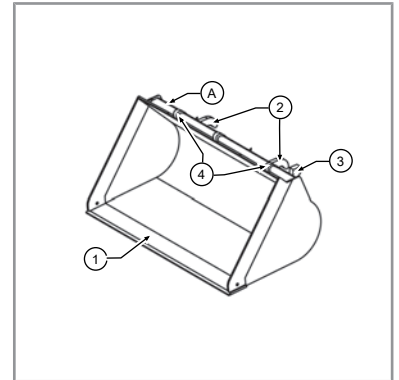

150522-1

9.8.2 Buckets description

All the buckets (fig.150523-1) consist of the following components:

1. Blade
2. Hooks for plate connection
3. Tilt indicator
4. Hooks for lifting

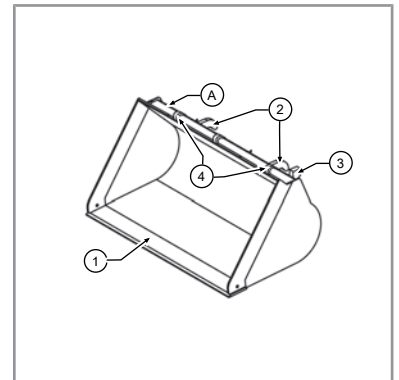

150523-1

9.8.3 Buckets safety stickers

Safety stickers on the winches (fig. 150524-1):

- AXA2427 - Keep the safety distance from the equipment

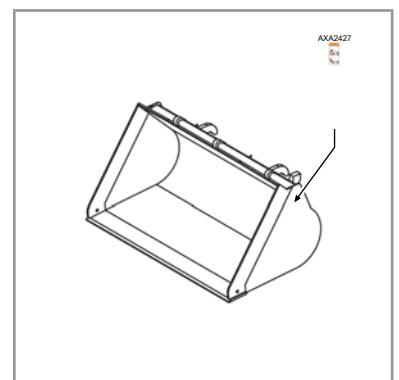

150524-1

9.8.4 Bucket use



WARNING

Before starting to use the equipment, inspect and test it as described in the section "Equipment pre-use check".

It is absolutely forbidden to use the forks or any type of equipment, without securing it to the tool holder plate with the appropriate safety pins.



DANGER

Before each use, check the wear status of the equipment, they could be worn out and not hold the load to be handled creating a dangerous situation.

Before starting to use the equipment, refer to the chapters:

- a) "Safety regulations"
- b) "Safe working procedures"
- c) "Equipment pre-use check"



CAUTION

Set the appropriate working mode of the vehicle during the bucket use. If this is not done properly, the anti-tipping device could start up and the movements will consequently stop during the bucket excavation or the loading.

To use the buckets it is sufficient to move the plates swiveling controls.

Moving the joystick to the left, the tip of the bucket will move up; moving the joystick to the right, the tip of the bucket will move down.

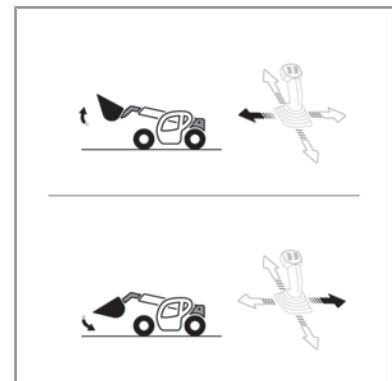

150630-1



WARNING

Given the large size of the buckets, for some movements it will be necessary to remove the boom to prevent contact of the bucket with other parts of the vehicle. It is advisable to operate with the minimum possible extension of the boom.

9.8.5 Tilting indicator use

In the left part of the bucket there is the leveling indicator (fig. 150525-1), this tool allows to know the angle of the bucket during use.

It is composed of an oscillating disk "1" and two indicators "2" and "3".

The position of the indicator fastened to the oscillating disk "2" compared to the indicator fastened to the bucket structure "3" indicates the angle of the bucket.

In case the indicator on the disk is:

- **Above:** the bucket is turned upwards
- **Even:** the bucket is aligned to the ground
- **Under:** the bucket is turned downwards

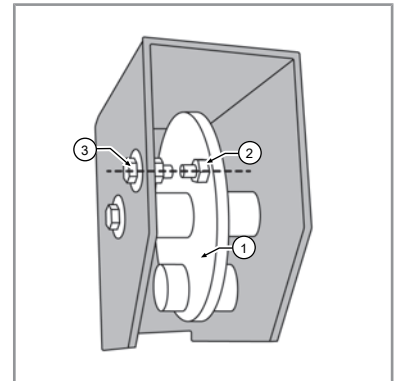

150525-1

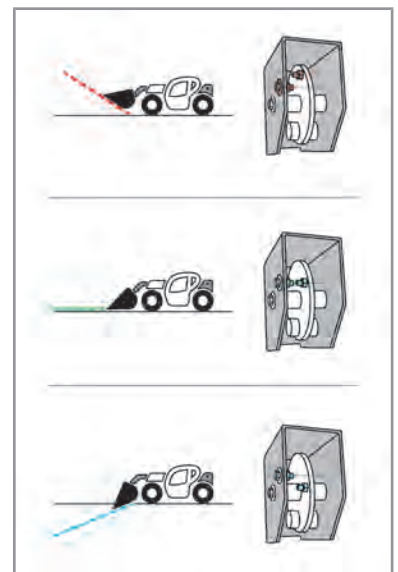

150525-2



CAUTION

During the bucket loading phase, to obtain the maximum efficiency of the bucket it is appropriate to use the bucket aligned to the ground.

9.8.6 Buckets Safe Working Procedures



DANGER

Do not change the structure of the equipment.



DANGER

Do not use the equipment for lifting persons, animals or things other than those specified.

9.8.6.1 Checks before lifting

Before starting the operations, perform these checks and inspections to ensure greater safety for operators.

- Positioning of the vehicle and ground conditions.
- Check the dimensions and characteristics of the work area and complete visibility of the load and of the surrounding area. Otherwise use a person on the ground assigned for signaling.

9.8.6.2 Danger zones

The danger zones of the vehicle can be identified in the work area of the vehicle and of the bucket.

This area varies in size depending on:

- Load characteristics and size
- Load lifting height



150631-1



DANGER

Keep away from the vehicle during operation and from the aggregates to be moved, or from the excavation.

9.8.6.3 Bucket load

It is strictly forbidden to push or stack inert material with extended boom. It can cause serious damage to the vehicle.

It is strictly forbidden to push or stack material using the boom extension. It can cause serious damage to the vehicle.

It is strictly forbidden to make leveling or digging operations in reverse. It can cause serious damage to the vehicle.

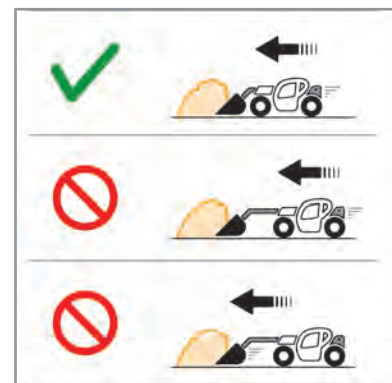

150632-1

9.8.6.4 Carry a load with bucket

The correct vehicle movement position with the bucket equipment installed is:

- Bucket as close as possible to the ground
- Boom retracted as much as possible

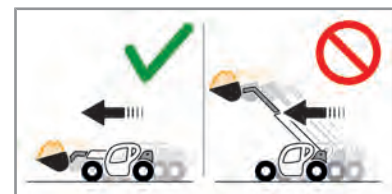

150633-1



WARNING

It is advisable to keep the bucket at a height sufficient to be able to avoid roughness of the terrain along the way.

9.9 Equipment lifting



WARNING

Make sure that the lifting device is adequate for the weight of the equipment to be lifted and that each device used for lifting and every accessory used is CE marked.

Make sure that the ropes, chains, straps and hooks are in good condition and with capacity adequate to the weight of the equipment to be lifted.

The weight of the equipment is shown on a special riveted metal plate; check the overall dimensions for the maximum and minimum height values from the ground and the weight allowed.

Position the hooks into the holes for the lifting locates at the top, at the center of gravity of the equipment.



DANGER

It is absolutely forbidden to transport the machine with the accessory still installed on it.

9.10 Equipment transport



WARNING

Make sure that the capacity of the means of transport is adequate for the weight of the equipment to carry.

When loading or unloading a machine, and its related accessories, from a means of transport, there is always the danger of overturning of the vehicle.

Use a truck or a trailer suitable for transport of the machine and its related accessories.

When transporting the equipment it is advised to use a support platform for easier handling.

Then fasten the equipment with appropriate slinging systems, check that they are in good condition and appropriate for the weight and dimensions of the equipment.



DANGER

It is absolutely forbidden to transport the machine with the accessory still installed on it.

For details on the procedures to be followed during transport of the machine, refer to the Use and Maintenance Manual of the machine on which the accessory will be installed.

10 Emergency procedure

10.1 Vehicle towing



DANGER

The machine towing is a delicate operation and the risks to the operator are high. The manufacturer's warranty is not applicable in case of incidents or accidents that occur during towing. If possible make repairs where the machine is located.

It is advisable that the towing operations are carried out by skilled personnel.

It is absolutely forbidden:

- Ever try to start the machine by pushing or towing.
- To tow the machine on public roads and for very long paths, if possible keep the yellow flashing light and the emergency lights in operation.
- To tow the machine on a slope.
- Stand between the towing machine and towed machine.



WARNING

With the engine off the steering wheel and brakes servo controls do not work. If it is not possible to keep the engine running while towing the vehicle take into account that the efforts to use the steering wheel will be much higher than normal.



CAUTION

The machine towing can be made only in emergency conditions at a maximum speed of 4 km/h (2.5 mph) and for short distances up to 500 m (1640 ft).

To tow the machine over longer distances, contact **Dieci** service center.



CAUTION

It is mandatory to tow the machine with a rigid towing bracket. The towing bracket must be designed for a tensile stress of 10 tonnes (22040 lb). Attach the towing bracket between towing vehicle and the vehicle in failure at the points prearranged for towing.



DANGER

Make sure that the weight of a towed vehicle not equipped with brakes never exceeds the weight of the machine that tows the vehicle. The distance required to stop the vehicle increases with the increase of the speed and of the load towed, in particular in the slope sections.

10.1.1 Towing the machine with engine in failure

In case it is necessary to tow the machine with engine in failure, follow the following steps:

- Attach the towing bracket between towing vehicle and the vehicle in failure at the points prearranged for towing (fig. 150568-1).
- Make sure that the machine is in a stable configuration and lock the wheels with chocks to prevent accidental movement of the machine.
- Follow the steps in the section "Manually disable the parking brake on the vehicle front axle".
- Follow the steps described in the chapter "Manually disable the towing".

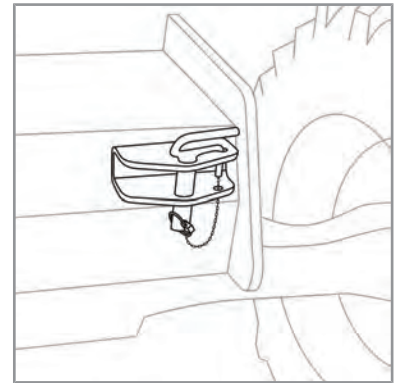

150568-1



DANGER

With the engine off, the drive and parking brake are still active.

Towing the machine with active drive and brake can cause serious damage to the machine and create dangerous situations.

10.2 Man basket recovery in case of failure

All vehicles with man basket or prearranged for its use, are equipped with a manual pump for operators recovery in case of emergency (vehicle malfunction).

The operations allowed through the emergency pump are:

- retract the boom extensions
- lower the boom



WARNING

Two qualified and experienced operators, authorized by the security officer, are required to complete the retraction operation.

To carry out the manual retraction of the boom, perform the following procedure.

- Remove the joystick "1" unscrewing the four fastening screws "2" (fig. 150721-1)
- Recover the rod for the pump activation in the tool box
- Fasten the rod to the pump "4" (fig. 150721-2)

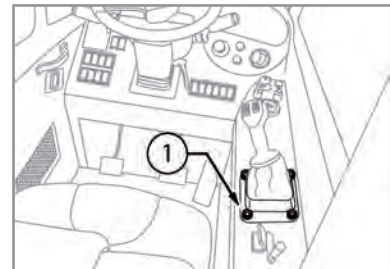

150721-1

Retract the boom:

- Operator 1 (fig. 150721-2):
 - Place the lever "5" in position "A"
 - Operate the hand pump by moving the lever
- Operator 2 (fig. 150721-3):
 - At the same time of the pump operation pull the lever "6" to the left to retract the boom extensions

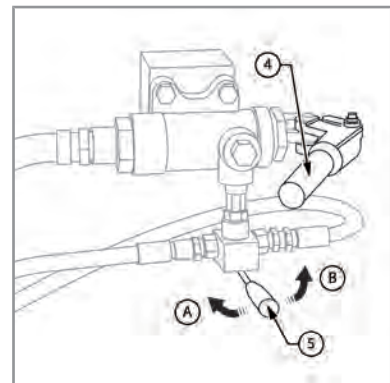

150721-2

To lower the boom:

- Operator 1 (fig. 150721-2):
 - Place the lever "5" in position "B"
 - Operate the hand pump by moving the lever
- Operator 2 (fig. 150721-3):
 - At the same time of the pump operation push the lever "5" to the right to lower the boom

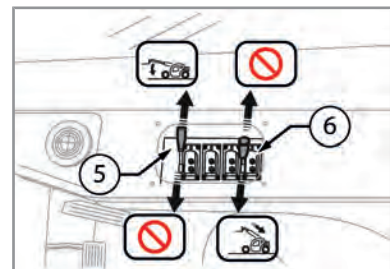

150721-3

To restore the initial conditions:

- Reassemble the plastic part "1" screwing again the screws "2".
- Put back the rod for the pump activation in the tool box

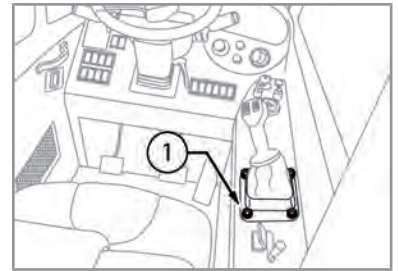

150721-6



WARNING

Move the basket alternating movements of boom retraction and extension, always remaining within the capacity diagram values.

11 Maintenance



WARNING

Before performing any maintenance operations set the vehicle in the maintenance position.

Use appropriate personal protective equipment during the various checking and maintenance operation of the vehicle.

11.1 Maintenance warnings

This vehicle or equipment has been designed and built to provide maximum performance, savings and facilitate its operation in various working conditions. Before delivery, the vehicle and the equipment were tested both by the Manufacturer and by the Dealer to ensure their maximum condition. In order to preserve these conditions and to ensure trouble free operation, it is important to perform routine maintenance, as specified in this Manual at a **DIECI** dealer at the frequency required.

This section of the Manual provides all the maintenance prescriptions necessary for maintaining the **DIECI** machine and equipment in perfect working condition.

It is recommended that all services must be carried out as part of the assistance program recommended by **DIECI**. Remember that the owner and/or user is responsible of keeping the vehicle and equipment in safe operating condition and able to operate.

It should be noted, also, that proper maintenance of vehicle and equipment not only improves reliability, but preserves its value over time.



CAUTION

Maintenance or repairs not covered in this chapter and in the rest of the manual should be performed by qualified personnel and in compliance with the safety conditions that ensure your safety and that of others. Only maintenance operators of DIECI Dealers are trained to carry out these specific operations and they alone have the specific tools and test equipment necessary to ensure maximum safety, accuracy and efficiency.

It is mandatory to have read and learned the "Safety" chapter before reading the "Maintenance" chapter.



WARNING

It is prohibited to carry out maintenance on the vehicle or equipment if this chapter has not been carefully read and learned.

To learn about maintenance operations and time, refer to the Maintenance Log.

All maintenance operations must be recorded on the appropriate Maintenance Log.



WARNING

When operating in corrosive environments it is important to intervene with appropriate maintenance methods and timing in order to prevent excessive wear of the vehicle or equipment.



CAUTION

Use appropriate personal protective equipment during the various checking and maintenance operation of the vehicle and equipment.



WARNING

In case of malfunction do not use the vehicle or the equipment until it has been repaired.



CAUTION

Any changes made on the machine or on the equipment involves a new conformity check. This procedure also applies in the case of repairs with non-original parts.

Only the following checks can be carried out by the operator: liquids level, air filter cleaning, tire pressure. These operations must be performed in compliance with safety standards as described in this manual.

11.1.1 Avoid accidents during maintenance

- Always clean and tidy the workplace in order to carry out every operation safely.
- Do not leave tools or other instruments scattered in a disorderly manner in the workplace.
- Clean grease traces, oil or other substances that could cause you to slip.
- For the workplace safety put rags soaked with grease and/or other flammable materials in a secure container.
- Use only tools appropriate for the task and make sure to use them in the right way. The use of damaged, poor quality, faulty, makeshift tools or not suitable for use may cause serious injury.
- Do not hit the vehicle and the equipment or their parts with a hammer or any other instrument, as projected fragments could cause injury.

- If inspection or maintenance is carried out on vehicles or equipment which are still covered with mud, oil, etc., operators risk sliding or falling and the visual analysis of components is made more difficult. Thoroughly clean the vehicle or equipment before every operation.
- Make sure about the maintenance procedures before starting the work.
- Keep the work area clean and dry.
- Replace worn or faulty components.
- Eliminate accumulations of grease oil and debris.
- The knurled plates (bulb plates) and the cab floor are the only parts of the vehicle that can be stepped on. Use a ladder (suitable for the intended purpose) for maintenance of parts that cannot be reached from the ground.



DANGER

Do not carry out any maintenance operation with running engine or moving vehicle.

Should maintenance need to be performed with the engine running, ask at least two workers for help and observe the following instructions:

- One worker must always be seated in the driver's seat, ready to switch off the engine at any time.
- All workers must remain in contact with one another.
- Take care not to remain entrapped in components during the execution of operations performed on the fan, fan belt or other rotating parts.
- Do not touch levers or control pedals. Should a lever or pedal need to be moved, always warn operators first so they can move out of the dangerous area.
- Do not allow instruments or other objects to fall into the vehicle rotating parts, as these parts may break and be projected out.
- The vehicle must be outdoors when the engine is running. The vehicle can be kept in a closed area only if it is properly ventilated and the vehicle is equipped with specific purifiers.



WARNING

If you need to work under raised mobile parts (booms, shovels, etc.) block them using spacers placed on cylinder rods or lean them up against appropriately sized supports.

If you need to perform repair or maintenance work under the vehicle, firmly support the equipment being used and the vehicle with blocks that are solid enough to support the weight.

- Store attachments removed from the vehicle in a safe place where they do not risk falling. Take precautions to prevent unauthorized persons from approaching the storage area.



DANGER

Do not rest metal parts on the battery.

- Welding operations must always be carried out by qualified welders and in areas equipped with suitable equipment. There is danger of gas leaks, fire or electrocution during welding operations. Do not allow unqualified personnel to carry out such operations.
- Disconnect the battery wires before working on the electrical system or before carrying out arc welding on the vehicle.

- When carrying out electric welding, connect the earth of the welding machine as close as possible to the area to be welded, and prevent the electric current from passing through ball bearings, articulated joints, hydraulic cylinders or sliding parts. If welding must be done in proximity to the oil or fuel tank, empty the tanks before welding.



DANGER

Danger of entanglement.

Damage may be caused by entanglement in moving parts. Prevent accidents while you are working by ensuring that hands, feet, clothing, jewelery and hair cannot get caught in moving parts.



DANGER

Exhaust gas danger

Exhaust engine gases are toxic and can damage your health.

The vehicle must be outdoors when the engine is running.

The vehicle can be kept in a closed area only if it is properly ventilated and the vehicle is equipped with specific purifiers.



DANGER

Pressurized liquids danger

After operation, the engine cooling liquid is hot and under pressure. Contact with hot water and/or steam may cause serious burns.

- Do not attempt to loosen connections, tubes or hydraulic components when circuits are under pressure.
- Avoid possible injury caused by hot water jets.
- Do not remove the radiator cap until the engine has cooled down.
- Before removing the cap, release all of the pressure.
- Prevent burns caused by oil or other hot parts during inspection or discharge by allowing the oil and cap to cool down before beginning operation.
- Even after the oil has cooled down, slightly loosen the cover or cap before removing it to mitigate pressure inside.



DANGER

Burns danger

Attention to burns. Engine reduction gear oil and the hydraulic system, pipes, engine and other components heat up when the vehicle is used. Wait until all parts cool down before beginning maintenance or repair work.

- Fluids such as fuel or hydraulic oil under pressure can penetrate the skin and eyes causing serious injuries. Take care to avoid these risks when repairing or doing maintenance work on the vehicle.

- Discharge the pressure (using the hydraulic levers of the distributors) before disconnecting or repairing pipes and hydraulic parts.



DANGER

When a hydraulic pipe needs to be disconnected, slowly loosen the fittings to discharge residual pressure.



DANGER

Pressurized liquids danger.

Hydraulic energy accumulators are mounted on the vehicle. Before intervening on them, make sure to discharge any internal pressure. Danger of high pressure oil splashes.

- Before restarting the engine, ensure that all connections have been properly tightened.
- Use a piece of cardboard to check for any leaks; make sure your body is adequately protected against pressurized fluids.
- Any fluids that penetrate the skin must be removed surgically. Should there be an accident, seek medical attention immediately.



DANGER

Corrosive substances danger

Never touch air conditioning coolant.

- If it comes into contact with eyes, air conditioning coolant may cause blindness; it may cause freezing if it comes into contact with skin.
- When cleaning with compressed air, serious injury may be caused by flying particles.
- Always wear protective goggles, a dust mask, gloves and other protective equipment.



WARNING

Adjusting and/or dismantling balancing and safety valves can be dangerous.

One of the above-mentioned valves may be removed only when the concerned jack is at rest and the hydraulic circuit is not under pressure.

All other operations must be carried out by qualified, authorized personnel only.



NOTICE

Only use lubricants suggested by DIECI; never utilize used lubricants.

11.2 Engine hood opening



DANGER

Do not open the hood with the diesel engine in motion. At the end of the maintenance operations the hood must always be closed and locked.

Do not work with the engine hood open.

To open the engine hood (fig. 150722-1):

- Turn off the diesel engine.
- Remove the ignition key.
- Place in the cab a sign showing "Maintenance in progress".
- Disconnect the battery using the battery cut-off switch.
- Pull the lever "1" toward the front of the vehicle until it clicks to unlock.
- Lift the engine hood "2" (fig. 150650-2) and fasten with the support rod "3" in the C hook on the hood "4".
- Release the hood gradually to ensure that the rod has been inserted correctly and does not release.

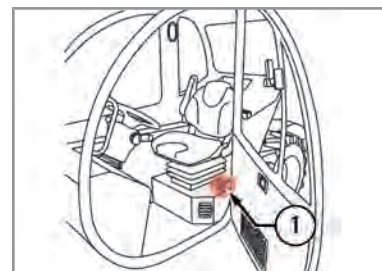

150722-1

To close the engine hood (fig. 150722-2):

- Hold the engine hood "2" and release the support rod "3" from the C hook "4" on the hood.
- Put back the support rod "5" in its seat
- Close the engine hood with light pressure. Always check the proper closing before starting to work or before leaving the vehicle.
- Reactivate the battery cut-off switch.

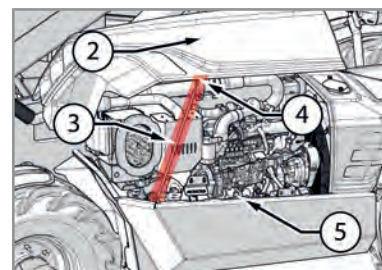

150722-2

11.3 Engine lower protection plate removal

To perform maintenance operations it is necessary to temporarily remove the engine lower protection plate of the vehicle. The lower protection plate protects the bottom of the vehicle, from any bumps, collisions, dirt.

To remove the engine lower protection plate (fig. 150723-1):

- Place the vehicle in the maintenance position.
- Lock the wheels with chocks to prevent accidental movement of the vehicle.
- Unscrew the fastening bolts with a wrench size **13** and remove the engine lower protection plate "1".

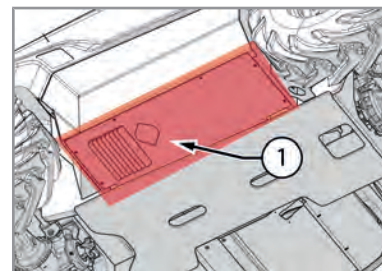

150723-1



CAUTION

At the end of the maintenance operations refit the engine lower protection plate.

11.4 Battery



DANGER

To avoid the risk of explosion of the batteries:

- a) Keep sparks, free flames and cigarettes away from the top of the batteries because the gases that they can produce are highly flammable.
- b) Do not charge damaged batteries.
- c) Do not charge a hot battery.



DANGER



Batteries contain highly polluting substances that must not be dispersed in the environment.

Dead, old, damaged, batteries etc. must be properly disposed of.



DANGER

The battery contains sulfuric acid electrolyte which is a corrosive substance and must be treated with caution because it can cause poisoning and severe burns.

Keep out of the reach of children.

Avoid contact with skin and eyes.



CAUTION

Wear protective clothing, gloves and safety glasses. In case of contact with eyes or skin, rinse immediately with plenty of water and seek medical attention. If swallowed, contact a doctor immediately.

- Do not overturn or tilt the battery as acid could come out.
- Charge the battery in a well ventilated area and always disconnect the power before removing the terminals.
- To check the charge status always use a voltmeter or a densimeter. If it is necessary to check the electrolyte level, use a flashlight, never a flame.
- Never place a metal object between the terminals to check the battery charge.
- Do not generate sparks with the cable terminals while charging the battery or starting the engine of the vehicle with an auxiliary battery.
- Check that the vent caps or covers are fitted correctly and firmly.
- Clean the top of the battery, check that the terminals are tight and cover them with a thin layer of petroleum jelly.
- In case of frozen battery this should be stored in a warm place to defrost. Do not use and do not recharge it: risk of explosion.
- In normal conditions the battery is kept charged by the alternator of the vehicle. If this becomes completely exhausted due to prolonged disuse or because at the end of its life the alternator loses its capacity to "regenerate". The battery must be replaced and recharged using a special battery charger tool.



WARNING

Before performing any maintenance on the vehicle, disconnect the power supply to the electric circuit of the machine by pressing the battery cut-off switch.

11.4.1 Low maintenance batteries

The low-maintenance batteries have been studied to avoid maintenance interventions in ordinary and normal use of the battery. In case of discharge check the electrolyte level. For technical specifications contact the supplier or the manufacturer.

11.4.2 "Zero" maintenance batteries

They are batteries that do not allow maintenance intervention.

When the battery is discharged it must be replaced. For technical specifications contact the supplier or the manufacturer.



DANGER

Do not carry out maintenance or recovery operations on "zero" maintenance batteries.

11.4.3 Battery: Instructions for recharging

- A battery is fully charged if at constant temperature the density of the electrolyte and the measured voltage at the poles does not increase within 2 hours.
- Each recharge will be good as good are the general conditions of the battery. This means that an old battery, after charging, will not have the same life and efficiency of a new battery.
- The simplest charging method is to charge at constant power.
- At the end of the charging, the battery charger voltage increases and creates gasification. It is recommended to use simple battery chargers with minimum current control and timer.
- If the battery has a low electrolyte level restore it to the minimum level (just above the plates limit) then charge them. After the charging is completed, fill to the maximum level (to prevent leakage).
- Overcharging must be avoided because:
 - It is a loss of energy which causes the dissociation of water.
 - It produces loss of active mass for the electrodes deterioration
 - It creates a risk of explosion.
- If sulfated batteries are recharged without voltage limitation, they will boil and warm up with a risk of explosion.
- For old batteries (in most cases sulfated) charge with great caution. Even with 13.8 Volts there is the possibility of a temperature increase.

Follow these instructions to recharge the battery:

1. Disconnect the cables of the vehicle from the battery to protect the electrical system of the vehicle.
2. Place the battery at a safe distance from the vehicle.
3. If possible, remove the caps.
4. Check the electrolyte level, if possible.
5. Clean the poles.
6. Make sure the room is sufficiently ventilated.
7. Limit the charging current to a maximum of 1/10 of the battery capacity (Ah).
8. Connect the battery to the charger.
9. Connect the charger to the mains.
10. Turn on the battery charger.
11. The battery temperature must not exceed 55°C.
12. After finishing switch off the battery charger.

13. Disconnect the battery charger from the mains.
14. Disconnect the battery from the charger.
15. Check the electrolyte level, if possible.
16. Refit the caps.

11.4.4 Battery cut-off switch



WARNING

Use this switch only when the engine is stopped.

The battery cut-off switch "1" (150731-1) allows the operator to isolate the battery from the electrical circuit in case of emergency or during maintenance operations.

To isolate the battery:

- Turn off the engine.
- Turn the ignition key to position "0".
- Turn the battery cut-off switch counterclockwise to the off position.

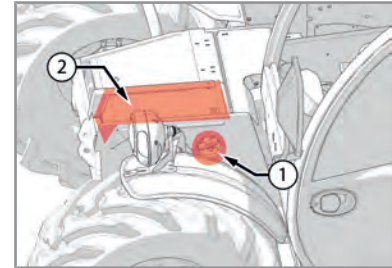

150731-1



NOTICE

If the vehicle is provided with the basket prearrangement it is also provided with a battery cut-off switch with removable key, to ensure that it is not used accidentally.

11.4.5 Battery: Replacement

The vehicle is equipped with a battery located on the front central part of the chassis "1" (fig. 150732-1).

Before removing the battery disconnect it from the electrical circuit through the appropriate battery cut-off switch, following the instructions given in the relevant chapter.

To remove the battery:

- Place the vehicle in the service position as described in the "Setting the vehicle for maintenance" section.
- To access the battery it is necessary to remove the protection guards.
- Disconnect the NEGATIVE cable (black) from the battery.
- Disconnect the POSITIVE cable (red) from the battery.
- Remove the battery from the vehicle.
- Place the new battery.
- Connect the POSITIVE (red) cable to the battery.
- Connect the NEGATIVE (black) cable to the battery.
- Reactivate the battery cut-off switch.
- Close the engine hood.

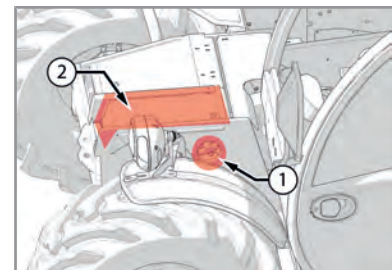

150732-1

11.4.6 Start up with auxiliary batteries



CAUTION

Start-up with auxiliary batteries is an operation that requires two properly trained and qualified operators.

An error in executing the operations can cause serious damage to the vehicle, to property and people.

- When starting the engine using another vehicle, connect the accumulators in parallel. When connecting the cables, avoid contact between the positive cable "+" and the negative cable "-".
- Wear the necessary personal protective equipment before starting the operation.
- Take care to avoid contact between the vehicle to be started and the vehicle that must supply power to prevent sparks and explosions of hydrogen produced by the accumulators. The accumulator explosion causes serious damage and injury.
- Make sure not to exchange the ignition wires and first connect the earth wire (-) and then the positive wire (+).
- Be very careful when removing the ignition cables; to ensure that the cables disconnected from the accumulator do not touch other parts of the vehicle to avoid explosions caused by hydrogen.
- Cables and clamps must be proportional to the current load to be transferred. The accumulator to be used for the start-up must have a capacity greater than or at least equal to that of the standard accumulator installed.
- Check the cables and clamps for corrosion or damage. Make sure the clamps are tightly gripping the terminals.
- Be very careful during the different operations: direct or indirect contact with live parts can result in injury and sometimes even in death.
- When starting the engine, the operator must be in the driver's seat so as to keep the vehicle under control.
- All these operations must be carried out by skilled and trained personnel.

11.4.6.1 Cable connection and engine start-up

1. Make sure the ignition key is in position "O".
2. Connect the positive terminals "+" of the two batteries to each other.
3. Connect the cable from the negative terminal "-" of the charged battery to the earth block of the vehicle to start-up.
4. If a charged battery installed on a properly running vehicle is used, start the engine of the latter and run it at high rpm.
5. Start the engine of the failed vehicle.

NOTICE! In case the battery is not easily accessible, it is possible to connect the cables through the battery cut-off switch of the vehicle.

1. Then connect the positive terminal "+" of the auxiliary battery to a connector of the battery cut-off switch.
2. Connect the negative terminal "-" of the auxiliary battery to a bolt on the frame.

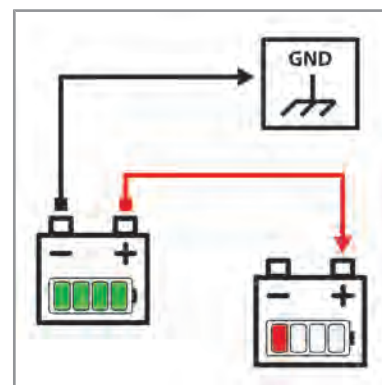

150539-1

11.4.6.2 Cables removal

With the engine running remove the cables in reverse order of the connection.

1. Disconnect the negative cable "-" from the earth of the running engine and therefore from the fully charged battery.
2. Disconnect the positive cable "+" first from the battery used for starting and then from the low battery.

11.5 Fuel



DANGER



Never add different types of fuel such as petrol or alcohol to diesel.



It is forbidden to refuel while the engine is running.



It is forbidden to smoke when refueling.



DANGER



Inhale diesel fumes for the least time possible as they are dangerous carcinogens for your health.

Before handling fuel and filling the tank, comply with the following regulations:

- Clean the area around the fuel cap. Refill the fuel tank at the end of every day to reduce condensation when the vehicle is at rest.
- Water and sediments must be removed before they reach the engine.
- Do not use antifreeze to remove water from diesel fuel.
- Do not rely on a filter to remove water from diesel fuel.
- Never leave the tank without a cap and always lock it. Should you lose the original cap, replace it with an original spare. Not just any cap is suitable.
- Keep the fuel pump gun under control while filling the tank.
- Do not inspect the tank with a flame.
- Do not fill up the tank completely. Leave room for expansion and immediately clean any spillage.
- In the event of fuel leaks due to breakage, stop the leak as quickly as possible, do not use the vehicle and contact DIECI customer service.

11.5.1 Specifications for recommended fuel



NOTICE

To achieve good performance, see the engine manual of the vehicle to know the best features.

11.5.2 Cleaning and storing fuel

It is important for the fuel to be kept clean.

The advice provided below will help maintain fuel quality.

- Never use zinc-coated containers.

- Never clean the inside of containers or power supply system components with cloths that may leave deposits.
- The cistern capacity (figure at the side) must allow intervals between refueling not to be too long. A capacity of 3000 liters is sufficient for an average sized company.
- The storage cistern must be covered and placed on a support that is high enough to allow refueling by means of gravity. A large basin must be placed under the cistern in case of fuel leakage. The cistern must have an opening large enough to allow someone to access it for cleaning purposes.
- The delivery tap must be larger at the bottom in order to trap any deposits; it must also be equipped with a removable filter. The cistern should be tilted 40 mm per meter towards the sedimentation drain plug.
- The fuel barrels (figure at the side) must be covered when stored to prevent water infiltration. The barrels should be slightly tilted slightly, so that any water will run to the upper rim. The fuel barrels should not be stored for too long before being used.
- If the barrels are kept outside, their caps must be tightly closed to prevent water from seeping in.
- After refueling the storage cisterns or barrels, it is recommended to allow the fuel to set for at least two hours, thereby allowing any sediment of water and impurities to be deposited before the fuel is used.

11.5.3 Refueling

When refueling (fig. 150724-1) it is necessary to:

- Park the vehicle and turn off the engine
- Open the fuel cap
- Refuel
- Close the fuel cap

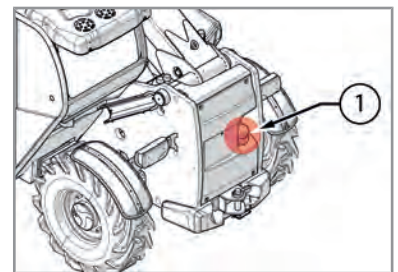

150724-1

11.5.4 Fuel tank: Cleaning

With the vehicle in the maintenance position:

- Place a suitable container under the fuel tank.
- Remove the cap from under the tank (fig. 150725-1) and drain the fuel to remove impurities present in the tank.
- Put back the cap and fill with clean fuel.

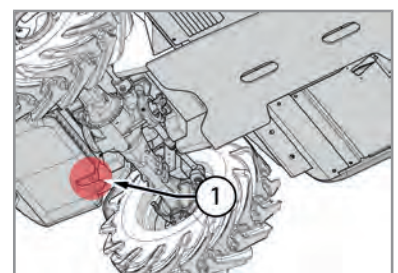

150725-1

11.5.5 Fuel filters: Replacement

In the front tool holder compartment (fig. 150991-1) there are the fuel pre-filter "1" and the fuel filter "2".

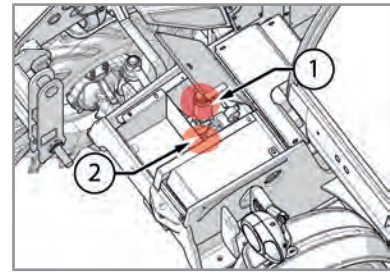

150991-1



NOTICE

Refer to the engine manual for the fuel filter replacement operations.

11.6 Safety stickers: Inspection

- Check that all safety stickers are intact and in good condition.



NOTICE

Refer to the chapter "Safety Stickers Cleaning" for cleaning the safety stickers.

11.7 Lubrication

Lubricate the points shown in the figure until grease comes out and clean the lubricators from dirt or deposits.

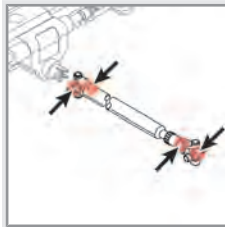

Drive shafts lubrication points.

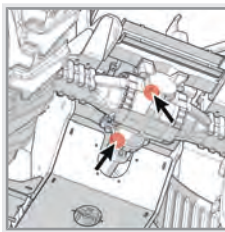

Swinging axle lubrication points.



Lifting cylinder lubrication points.

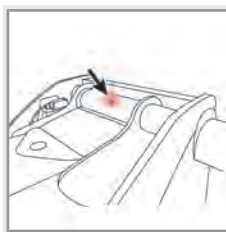

Boom-chassis pin lubrication points.

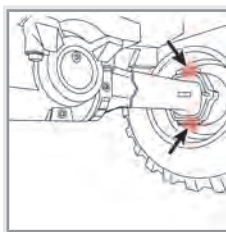

Wheels lubrication points.

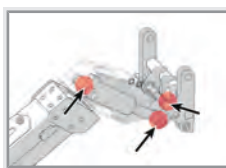

Swinging cylinder lubrication points.

11.8 Preliminary maintenance operations

11.8.1 Prepare the vehicle for maintenance



CAUTION

Before performing maintenance work on your vehicle, do the following:

- Park the vehicle on flat, even ground.
- Engage the parking brake.
- Lower and fully retract all mobile parts (booms, shovels, etc.).
- If the maintenance operation requires the mobile parts to remain up, apply the safety rod.
- Run the engine at a minimum for 60 seconds to cool it down.
- Release residual pressure from the hydraulic system.
- Switch off the key in the ignition switch.
- Remove the ignition key.
- Hang up a sign that indicates maintenance work is underway. This sign can be hung on the cab door and inside it on the controls.
- Set up barriers and spacers to prevent unauthorized personnel from approaching the vehicle.
- Disconnect the battery cut-off switch.
- Allow the engine to cool down.



WARNING

Use appropriate personal protective equipment during the various checking and maintenance operation of the vehicle.

11.9 Engine maintenance



NOTICE

For the engine maintenance operations, refer to it manual.

11.9.1 Belts: Check and adjustment

Check that the belt "1" (fig. 150726-1) does not have cuts, cracks or rubbing signs; when in doubt, install a new belt.

Make sure that the belt is properly fit on the pulleys and that the tensioner is working properly.

NOTICE! If the belt does not appear in good condition, replace it with a new one.

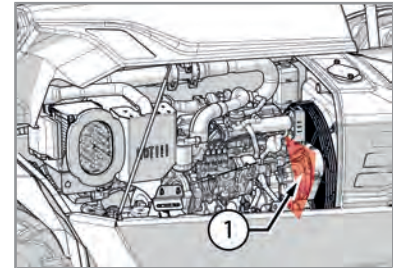

150726-1

11.9.2 Engine oil: Check and filling up

- Check the level with the vehicle on level ground and the engine turned off. Wait at least 5 minutes to allow the oil to settle into the sump.
- Pull out the dipstick "1" (fig. 150727-1), clean it and insert it back fully down.
- Pull out again the dipstick "1" and check that the oil level is between the "MIN" and "MAX" mark.
- Put back the dipstick and insert it fully down.
- If necessary, add oil from the cap on the engine "2".

For the amount and type of oil, refer to the engine manual.

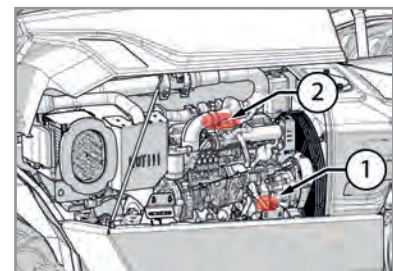

150727-1



WARNING

Do not fill beyond the "MAX" mark; if the amount is excessive, oil burns with production of smoke and possible damage to the DPF.

Never operate the engine with the oil level below the "MIN" mark.

11.10 Air filter: Cartridges cleaning and replacement



CAUTION

The inspection, cleaning and replacement must be carried out with the vehicle in the maintenance position.

An air filter (fig. 150615-1) in bad conditions results in the reduction of power, excessive fuel consumption and reduced engine life.

A clogged filter is signaled by the indicator light (fig.150615-2) located on the instrument panel of the vehicle; after the clogging indication it is possible to continue operating for a period not longer than 10 hours. The maintenance must however be performed at the frequency required.

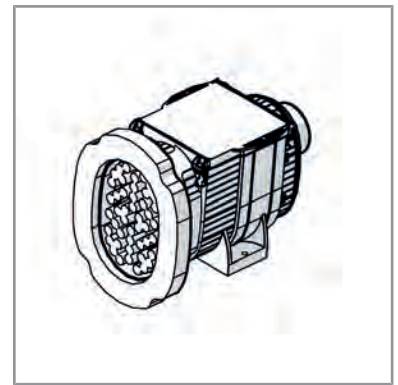

150615-1



150615-2



WARNING

When the clogging is indicated, it is possible to continue working for not more than one hour.

It is recommended to:

- Clean the filters only when the indicator light indicates clogging or at the frequency required. Unnecessary and too frequent cleaning exposes the elements to damage by handling that can allow dust and dirt to pass through the filtering stage and cause engine damage.
- In case the filter elements are in contact with liquids of any kind they must be replaced.
- Periodically check the suction hoses, replace them immediately in case they are damaged or deteriorated.
- Periodically check the tightness of the bolts and clamps. Air must not be allowed to get into the engine circulation without having first gone through the filter.

For the complete efficiency of the filter it is recommended to operate with the filter complete with all its parts and components, assembled in the correct way.

Each deteriorated part must be replaced as soon as possible.



CAUTION

For the complete efficiency of the filter it is recommended to operate with the filter complete with all its parts and components.

Each deteriorated part must be replaced as soon as possible.

It is absolutely forbidden to operate without the engine air filter.

The engine sucks air constantly during its use; dust particles entering in circulation may cause serious damage.

For proper cleaning of the filter it is necessary to:

- Prepare the vehicle in the maintenance position.
- Open and lock the hood.
- Open the filter cover (fig. 150615-3) pulling the locking levers located on the four corners.
- Lift the cover and remove the cartridge from inside the filter (fig. 150615-4).
- Use a wet lint-free cloth to clean the box and the cover.
- Clean or replace the filters. The filter cleaning is carried out with compressed air, up to **3 bar** (43.5 psi), at a distance of not less than **150 mm** (5.9 in), taking care not to damage the filtering element.
- Reassemble everything carrying out the same operations in reverse.

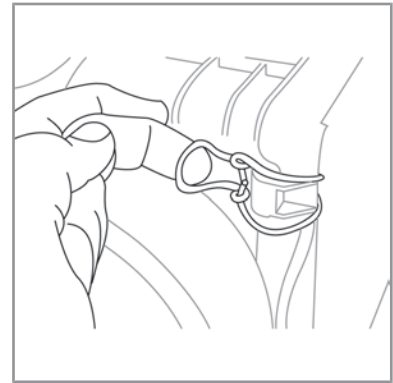

150615-3

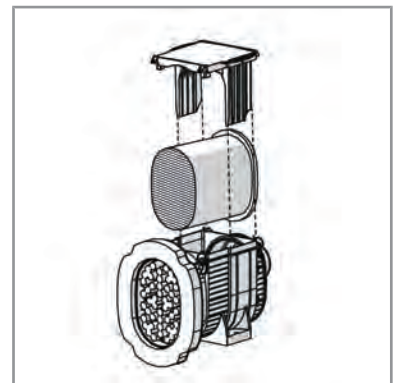

150615-4

For a correct cleaning of the intake ducts it is necessary to:

- Prepare the vehicle in the maintenance position.
- Open and lock the hood.
- Loosen the screw that secures the inlet honeycomb.
- Remove the air inlet honeycomb (fig. 150615-5).
- Use a wet lint-free cloth for cleaning. Clean every air inlet hole.
- Put back the inlet honeycomb in its seat.

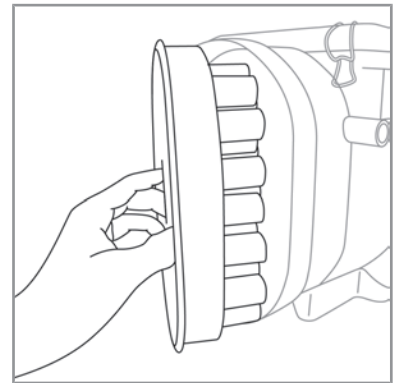

150615-5



NOTICE

In case the sealing connection between the suction duct and the filter is damaged, it must be replaced.

11.11 Radiator maintenance

11.11.1 Air recirculation grids and nets

Check that the air recirculation grids and nets (fig. 150728-1) are clean and free from dirt:

For cleaning use a jet of air at low pressure from the inside to the outside of the vehicle.

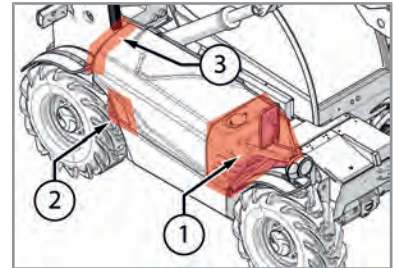

150728-1

11.11.2 Radiator: Checking and cleaning

The oil and water radiator "1" (fig. 150729-1) involve the following steps:

Radiators check

Check that the fins are not deformed; in that case straighten with caution.

Check that the fins have not accumulated dirt and that they are not obstructed.

Radiators cleaning

Prepare the vehicle in the maintenance position.

Clean the radiator from dirt and impurities accumulated between the cooling fins. For cleaning use compressed air with pressure not exceeding 7 bar directed from the inside towards the outside.

If necessary, apply a detergent solution and then remove it with a pressure washer.

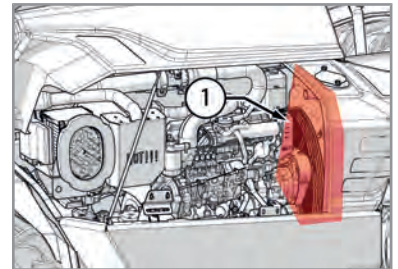

150729-1

11.11.3 Radiator: Liquid filling up and replacement



DANGER

Do not remove the filler cap of the radiator when the system is hot, otherwise it could cause leakage of boiling coolant. Once the system has cooled, turn the filler cap to the first mark and wait until the pressure has completely exhausted before proceeding.

Risk of burns and injuries.



DANGER

The coolant can be toxic. Avoid contact with skin, eyes or clothing. Rinse thoroughly with water in case of contact with skin and eyes. Consult a doctor immediately.

If not reused, dispose of in accordance with local environmental regulations.

Filling up

To check the level of coolant in the radiator (fig. 150730-1):

- Prepare the vehicle in the maintenance position.
- Wait for the complete cooling of the vehicle.
- Remove the guard "1" by removing the two fastening screws to access the radiator cap "2".
- Slowly unscrew the filler cap "2" counterclockwise up to the safety stop.
- Check the coolant level through the cap. If below 30 mm (1.2 in) from the cap, perform the topping up operations.
- Put back the cap "2".
- Close again the protective casing "1".
- Open the engine hood.
- Check the level of coolant in the expansion tank "3". the level must always be between the minimum level "MIN" and the "MAX" level.
- If the level is below "MIN", remove the cap on the expansion tank and top up the level.
- Close the engine hood.

WARNING! The coolant level in the expansion tank "3", refers only to the tank, it is not the total coolant level.

Coolant replacement

To replace the coolant (fig. 150730-2):

- Prepare the vehicle in the maintenance position.
- Wait for the complete cooling of the vehicle.
- Open the engine upper hood.
- Remove the discharge sleeve "3" (Fig. 14-M0120) to drain water from the radiator.
- Remove the guard "1" by removing the two fastening screws to access the radiator cap "2" (Fig. 15-M0120).
- Remove the filler cap "2" to speed draining.
- Allow the cooling system to completely drain.
- Rinse the radiator with clean demineralized water introducing it from the filler cap "2" and making it flow out from the orifice of the sleeve "3". If necessary, add detergent.
- Check the condition of sleeves and their fittings, replace them if necessary.
- Once cleaning has been completed, refit the drain sleeve "3".
- Fill the cooling system from the filler cap "2" until the level is 30 mm (1.2 in) below the cap with the coolant previously prepared.
- Close the filler cap "2".
- Put back the protective casing "1".
- Start the engine at idle speed for a few minutes.

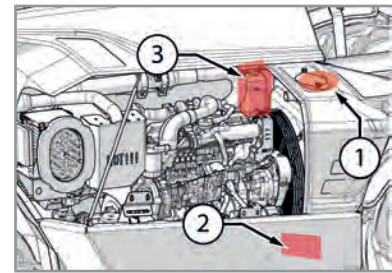

150730-1

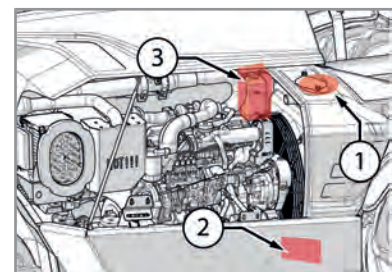

150730-2

- Make sure there are no leaks, check the level and add more liquid if necessary.

WARNING! The coolant level in the expansion tank "3", refers only to the tank, it is not the total coolant level.

11.12 Hydraulic system maintenance

11.12.1 Hydraulic oil: Check and replacement

The hydraulic oil tank is located at the rear center of the frame, under the telescopic boom.

The level can be checked through the transparent cap placed on the left side of the vehicle "1" (fig. 150908-1).

The level is correct when the oil is visible from the transparent cap "1" with all the cylinders of the vehicle in the transport position.

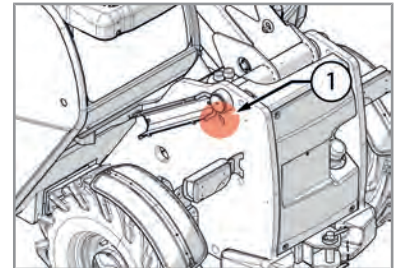

150908-1



NOTICE

See the chapter "Technical data" to know the amount and type of recommended oil.

Oil check

To keep the vehicle in normal operation conditions, it is necessary to keep the oil level in best conditions.

To properly check the oil level in the tank it is necessary to:

- Prepare the vehicle in the maintenance position.
- Make sure that all cylinders and jacks of the vehicle are retracted (e.g. telescopic boom fully retracted and lowered, tools holder plate tilted down as much as possible to avoid contact with chassis or tires). In this way all the oil of the hydraulic circuit will be sent in the tank.
- Check the oil level through the transparent cap "1" (fig. 150980-2). Under the best conditions, the oil level reaches the middle of the transparent indicator.
- If necessary, remove the cap "1" (fig. 150980-3) and add oil until it reaches the proper level.

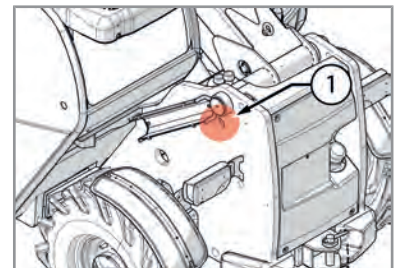

150980-2

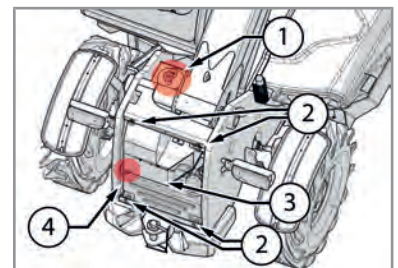

150980-3

Oil change

To change the oil in the tank it is necessary to:

- Prepare the vehicle in the maintenance position.
- Make sure that all cylinders and jacks of the vehicle are retracted (e.g. telescopic boom fully retracted and lowered, tools holder plate tilted down as much as possible to avoid contact with chassis or tires). In this way all the oil of the hydraulic circuit will be sent in the tank.

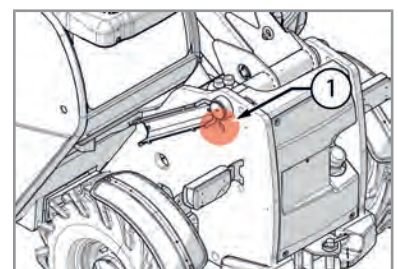

- Place a container under the drain plug (located under the tank).
- Remove the filler cap "1" (fig. 150980-5)
- Remove the rear protective casing "3" (fig. 150980-5) removing the 4 screws at the corners "2" (fig. 150980-5).
- Remove the drain plug to let the oil drain "4" (fig. 150980-5).
- Put back the drain plug "4" (fig. 150980-5).
- Reassemble the rear protective casing "3" (fig. 150980-5).
- Fill the tank with the oil indicated
- Check the level through the indicator "1" (fig. 150980-4) after starting the engine and operated all hydraulic controls to remove air bubbles, if any.
- If necessary, top up the level.

150980-4

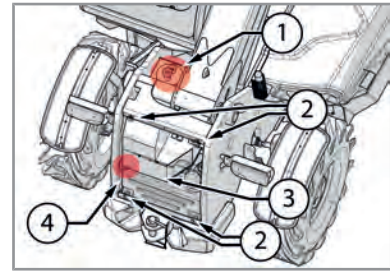

150980-5

11.12.2 Internal hydraulic oil intake filter: Replacement

The internal hydraulic oil intake filters are located inside the hydraulic oil tank; to replace them, completely empty the tank. It is therefore advisable to carry out the replacement of the intake filters in conjunction with the oil change.

To replace the intake filter, carry out the following operations:

- Prepare the vehicle in the maintenance position.
- Make sure that all cylinders and jacks of the vehicle are retracted (e.g. telescopic boom fully retracted and lowered, tools holder plate tilted down as much as possible to avoid contact with chassis or tires). In this way all the oil of the hydraulic circuit will be sent in the tank.
- Place a container under the drain plug (located under the tank).
- Remove the filler cap "1" (fig. 150981-1).
- Remove the rear protective casing "3" (fig. 150981-2) removing the 4 screws at the corners "2" (fig. 150981-2).
- Remove the drain plug to let the oil drain "4" (fig. 150981-2).
- After completely draining the oil, remove the flange "1" (fig. 150981-2) to access to the intake filters.
- Unscrew the intake filter located inside the tank with an adjustable spanner.
- Install new filters and tighten with a wrench.
- Remove the flange "1" (fig. 150981-2)
- Put back the drain plug "4" (fig. 150981-2).
- Reassemble the rear protective casing "3" (fig. 150981-2).
- Fill the tank with the oil indicated.
- Close the filler cap "1" (fig. 150981-2).
- Check the level through the indicator "1" (fig. 150981-1) after starting the engine and operated all hydraulic controls to remove air bubbles, if any.
- If necessary, top up the level.

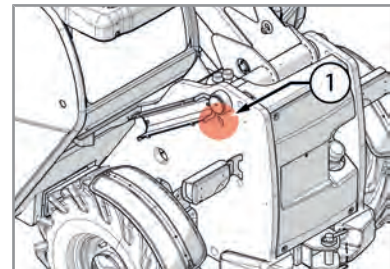

150981-1

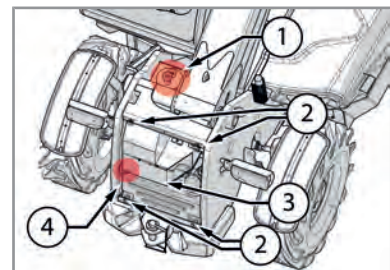

150981-2

11.12.3 External hydraulic oil intake filter: Replacement

To replace the hydraulic oil filter carry out the following operations:

- Prepare the vehicle in the maintenance position.
- Turn on the vehicle and lift the boom just enough to insert the safety rod on the lifting cylinder rod.
- Turn off the engine and remove the ignition key, place a sign in the cab showing "Maintenance in progress".
- Insert the "boom support" safety rod on the rod of the lifting cylinder, apply appropriate safety supports to the telescopic boom.
- Allow engine and hydraulic oil to cool down.
- Remove the safety clamp from the valve located inside the chassis "1" (fig. 150982-1).
- Remove the engine lower protection plate "1" (fig. 150982-2).
- Place a container under the oil filter "2" (fig. 150982-2) to collect the oil that may spill during the change.
- Replace the filter "2" (fig. 150982-2), lightly oil the gasket and tighten by hand for 3/4 of a turn.
- Put back the engine lower protection plate.
- Open the valve to position "1" (fig. 150982-1) previously closed and fasten with a new clamp.

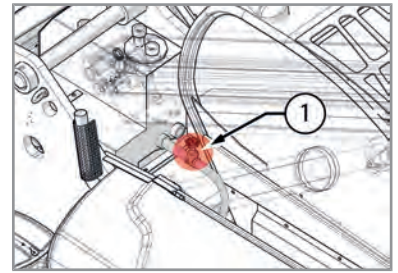

150982-1

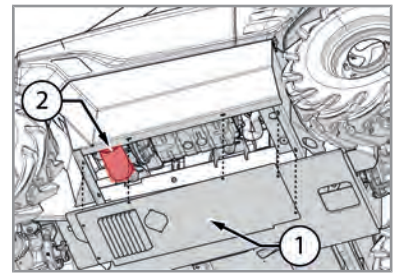

150982-2

11.13 Brakes maintenance

11.13.1 Brake: Inspection

Visually check that the joints of the pedals (fig. 150708-1) are not damaged and that the pedal stroke is not excessive or too elastic.

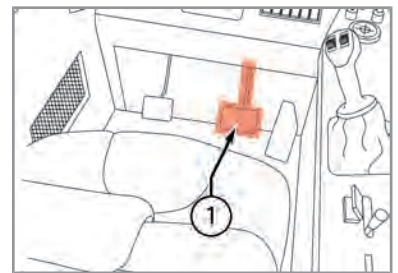

150708-1



DANGER

If irregularities in braking are noticed, contact qualified personnel to verify the cause of the trouble.

The braking parts also safeguard the operator's safety, it is recommended not to intervene personally on the braking system trying to eliminate possible anomalies.

11.13.2 Brake: Coolant level check

When the indicator light flashes on the central instrument panel (fig. 150709-1: Brake oil level low) it means that the brake fluid level has dropped below the minimum (MIN) and therefore it must be restored.

Periodically check the tank "1" (fig. 150709-2) that is located behind the seat.

WARNING! If the light stays on even after adding oil, contact a Dieci authorized service center to solve the problem.

A slight lowering of the level is due to normal wear of the brake discs.

Do not press the brake pedal until the topping up is completed. Make sure the tank is closed before acting on the pedal.



150709-2

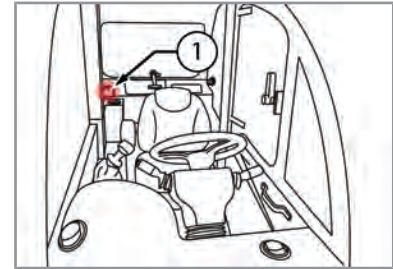

150709-1



DANGER

The significant lowering of the level is an indication of leakage in the system. Refer to qualified staff for the replacement of any damaged, corroded or ruined pipe.

It is absolutely forbidden to operate with brake oil level below the minimum "MIN". The brakes may operate erratically with the risk of accidents.



CAUTION

Type and source of hazard

Always use oil of the prescribed grade, as indicated in "Technical data" chapter.

This type of oil can damage painted surfaces and plastic parts of the instrument panel. For safety precautions, refer to the "Safety regulations" chapter.

11.14 Wheel maintenance

11.14.1 Epicycloidal reduction gear oil: Check and replacement

The oil cap of the epicycloidal reduction gear is located on the hub of the wheel (fig. 150577-1):

When checking the oil level it is necessary to:

- Prepare the vehicle in the maintenance position.
- Turn the wheel for the oil cap to be in the horizontal position (9 o'clock).
- Place a container to collect the oil.
- Remove the cap and verify that the oil seeps from the hole.
- If necessary, top-up through the same hole.
- Close the cap and tighten it securely.

When replacing the oil it is necessary to:

- Prepare the vehicle in the maintenance position.

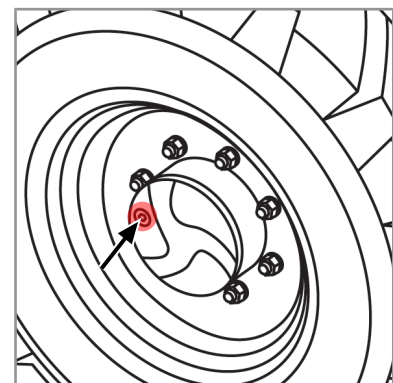

150577-1

- Turn the wheel for the oil cap to be in the lowest possible position (6 o'clock).
- Place a container to collect the oil.
- Remove the cap and let the oil drain completely
- Turn the wheel and bring the cap to the horizontal position (9 o'clock).
- Fill through the same cap with new oil until it seeps through.
- Close the cap and tighten it securely.

11.14.2 Wheel nuts tightening



NOTICE

Tighten the nuts at the intervals required in the maintenance table.

Use the corresponding table to know the correct tightening torque.

Always tighten the nuts in opposing position, not consecutively.

After installing the wheel, tighten the nuts between the wheel and the axles. Then check the nut torque every day until the torque is stabilized.

The number of axle columns must match the number of nuts tightened. Then all the nuts on each wheel must be installed otherwise the vehicle can not operate.

In case of wheel replacement the vehicle or the raised side can be placed on the ground only with wheels installed and properly tightened.

The nuts tightening must be made first with the vehicle, or part of it, raised from the ground then with vehicle resting on the ground.

Only use **DIECI** original nuts for tightening the wheels. If you lose even one nut contact the **DIECI** service center.

11.14.2.1 Wheel nuts tightening: Inspection

Check that the nuts of the front and rear wheels are tightened well, using a torque wrench (with a torque multiplier, if necessary).

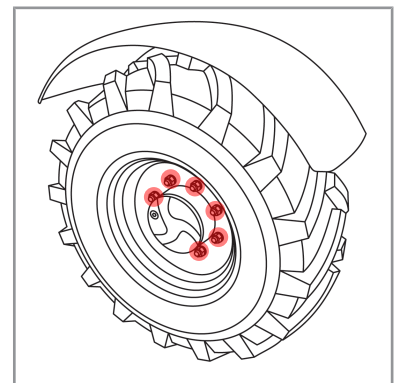

150578-1

Tapered nut	Torque
M18x1.5	460 N·m (339,02 ft·lbs)
M22x1.5	740 N·m (545,38 ft·lbs)

11.14.3 Tires



CAUTION

On receiving the machine check the air pressure of the tires.

- Check the tire pressure regularly. The pressure must be checked with cold tires.
- The tire pressure must always be at the levels indicated.
- Check the size of the tires installed and the canvass amount for the correct inflation pressure.



DANGER

Tires showing cuts or excessive wear must be replaced immediately.

- At each use, check that the tire shoulders are not damaged.
- Keep oil, grease and corrosive liquids away from the tires to avoid deterioration of the rubber.
- To obtain the maximum efficiency do not use tires with more than 80% of tread wear.



WARNING

Inflating or operating on the tires can be dangerous.

To operate on tires or install them, contact specialized personnel.

In any case, to prevent serious or fatal injuries, follow the safety precautions below.

- The vehicle wheels are very heavy. Handle with care and make sure that, once stored, they can not fall and injure someone.
- Never try to repair a tire on a public road or highway.
- Make sure the jack is placed on a solid and flat surface.
- Make sure the jack is adequate for lifting the vehicle.
- Use ratchet jacks or other locking means suitable to support the machine during the tires repair.
- Do not place any part of the body under the vehicle.
- Do not start the engine while the vehicle is on the jack.
- Never hit a tire or a rim with a hammer.
- Make sure the rim is clean, without rust and undamaged. Do not weld, solder, repair in any way or use a damaged rim.
- Do not re-inflate a tire that has traveled completely or very deflated until it has been duly inspected by a qualified technician.
- Do not inflate a tire unless the rim is mounted on the machine or secured in such a way that it cannot move in case the tire or rim should break suddenly.
- Do not inflate any tire over the pressure indicated by **DIECI**. If the bead chafer does not settle on the rim, when arriving to this pressure deflate the tire and lubricate again with a solution of soap and water, inflate again. Do not use oil or grease. An inflation greater than permitted with bead chafer not settled may break the bead or rim with explosive force sufficient to cause serious injury.
- After installing the wheel, tighten the nuts between the wheel and the axles. Then check the nut torque every day until the torque is stabilized.



CAUTION

When fitting a new or repaired tire, use a valve adapter of spring type with distant pressure gauge that allows the operator to stay well away from the tire during inflation.

Use a safety cage.

11.14.3.1 Tire pressure: Inspection

Verify and adjust the pressure of the front and rear tires.

Check that the tread and the sides are not damaged.

Connect a manometer to the tire valve and verify that the inflation pressure is correct.

NOTICE! Adjust the tire pressure according to the indications provided in the "Tires Data" chapter.

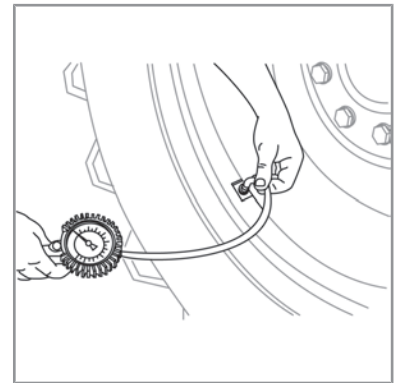

150578-1

11.14.3.2 Tires filled with urethane



NOTICE

Tires filling with urethane is an optional accessory.

Consult your dealer in case of doubts or information on your vehicle.



DANGER

It is not permitted to fit tires inflated with polyurethane foam unless authorized by the manufacturer.

With tires filled with urethane it is forbidden to travel on the road.



CAUTION

The maximum permitted speed with tires filled with urethane is 20 km/h (12.4 mph).

11.15 Lighting

The machine lighting must always be efficient and fully functional. Its operation must be checked every day. In case of damage to the lighting system immediately replace the damaged part. Immediately replace a burned out bulb.



CAUTION

Refer to the "Maintenance" chapter before making any adjustments or maintenance.



NOTICE

The bulbs are very fragile. Handle with care.

The low beam bulbs must not be handled with bare hands.

11.15.1 Headlight

The front light (fig. 150301-1) is composed of:

1. Direction indicator - 21 W
2. Front side light- 4 W
3. Low beam and high beam light - 60/55 W H4

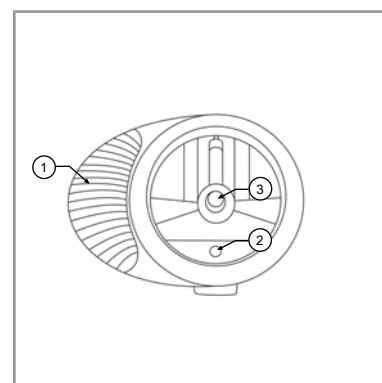

150301-1

To access the bulbs:

- Prepare the vehicle in the maintenance position.
- Turn off the battery cut-off switch to disconnect power to the electrical system.
- Remove the power supply connector on the back of the light.
- Remove the front of the headlight by loosening the screws placed in the rear cap.

To close the headlight operate in the reverse order, paying attention to correct positioning of the gasket.

Direction indicator bulb replacement

- Press the top of the bulb (fig. 150302-1).
- Turn the bulb, keeping it pressed, to release it from the lock.
- Perform the same procedure to insert the new bulb.

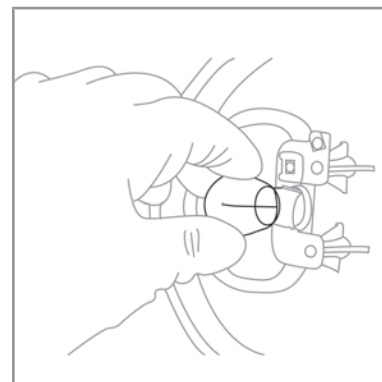

150302-1

Sidelight bulb replacement

- Grasp the rear part where the electrical connections are placed (fig. 150302-2).
- Turn and pull the rear part towards you.
- Extract the support, press the top of the bulb.
- Turn the bulb, keeping it pressed, to release it from the lock.
- Perform the same procedure to insert the new bulb. Put back the support inside its seat.

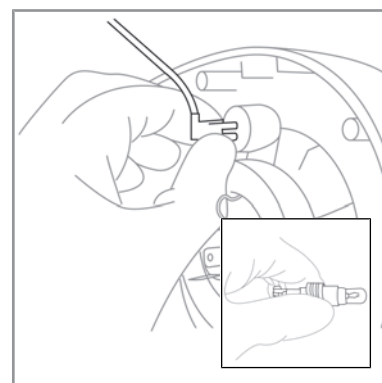

150302-2

Low/high beam light bulb replacement

- Remove the electrical connector pulling it towards you.
- Lift the locking tabs (fig. 150302-3) moving them sideways to release the bulb.
- After replacing the bulb, proceed in the reverse order to lock and connect it again. Observe the joints of the lamp for proper insertion.

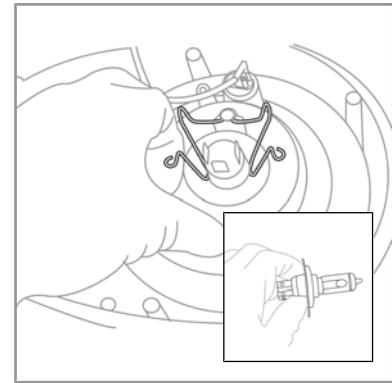

150302-3

11.15.2 Tail light

The tail light (fig. 150304-1) is composed of:

- Reversing light - 21 W
- Rear side light- 5 W
- Braking light - 21 W
- Direction indicator - 21 W
- Rear fog light - 21 W

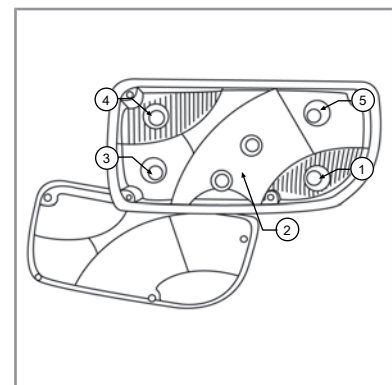

120304-1

To access the bulbs:

1. Prepare the vehicle in the maintenance position.
2. Turn off the battery cut-off switch to disconnect power to the electrical system.
3. Remove the power supply connector on the back of the light.
4. Remove the front of the headlight by loosening the screws placed in the cap.

To close the headlight operate in the reverse order, paying attention to correct positioning of the gasket.

Tail light bulb replacement.

- Press the top of the bulb.
- Turn the bulb, keeping it pressed, to release it from the lock.
- Perform the same procedure in reverse order to insert the new bulb.

11.15.3 Work light ***NOTICE**

* The work light is an optional accessory.

Work light bulb replacement

To access the bulbs (fig. 150305-1):

- Prepare the vehicle in the maintenance position.
- Turn off the battery cut-off switch to disconnect power to the electrical system.
- Remove the power connector at the back of the light "1".
- Press the connector socket on the light "2".
- Turn the socket, keeping it pressed, to release it from the lock.
- Perform the same procedure in reverse order to insert the new bulb.

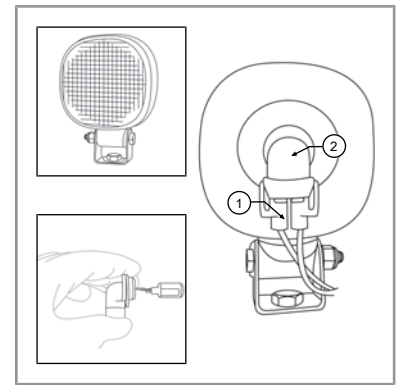

150305-1

11.15.4 Led work light*



NOTICE

* The LED work light is an optional accessory.

The LED work light (fig. 150303-1) does not require maintenance.



150303-1

11.16 Window washer fluid tank

The washer fluid tank is located in the cab on the left side of the seat "1" (fig. 150466-1).

To add liquid to the tank:

1. Remove the filler cap.
2. Add washing fluid to fill the tank.
3. Put back the cap.

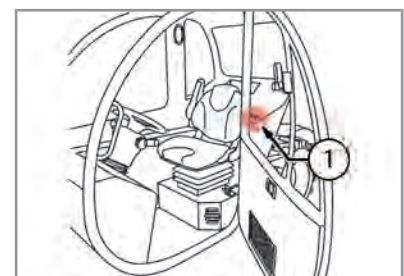

150466-1



CAUTION

During the winter, mix antifreeze fluid to the water.

11.17 Ventilation system maintenance

11.17.1 Cab ventilation filter: Cleaning and replacement

When changing the cab ventilation filter, clean the intake duct with a jet of air from inside the cabin to the outside.

- Prepare the vehicle in the maintenance position.
- Remove the casing "2" (fig. 150992-1), located at the bottom rear of the driver's cab.
- Remove the filter.
- Replace or clean the filter cartridge by tapping gently on a flat surface, with the outer side facing down, being careful not to damage it; or use a jet of air (less than 6.9 bar) by blowing from the inside to the outside.
- Reassemble the filter.
- Reassemble the cover.
- Restart the engine with the fan in motion to verify the correctness of the operations.

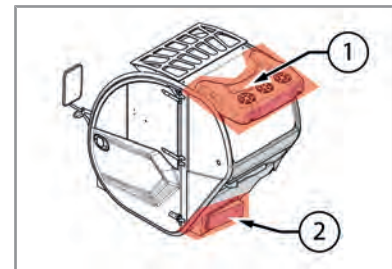

150992-1

Clean the air intake grid at the end of each working day with a jet of air.



DANGER

Do not use diesel fuel, gasoline, solvents or water to clean the cartridges, as this may damage the filtering material.



WARNING

If the vehicle is used in environments particularly rich of dust (barns, etc.), the filter life is reduced to 100 hours.



WARNING

In case of malfunction of the ventilation system, check the filter clogging.

In the event that the malfunction continues despite the filter replacement, contact DIECI service center.



DANGER

Do not use the vehicle without a cab filter.

The entry of dust into the cab may involve risks to the health of the operator and breakage of the ventilation system.

11.17.2 Air conditioning: Cleaning *



NOTICE

Air conditioning is an optional accessory.

- Prepare the vehicle in the maintenance position.
- Remove the protective casing "1" (fig. 150993-1).
- Clean the air conditioning radiator directing compressed air at a maximum pressure of 7 bar, from the top downwards, in the direction opposite to that of the normal flow of air. The air flow must be perpendicular to the radiator surface.
- Remove dirt from under the air conditioning radiator.
- After cleaning, refit the condenser.

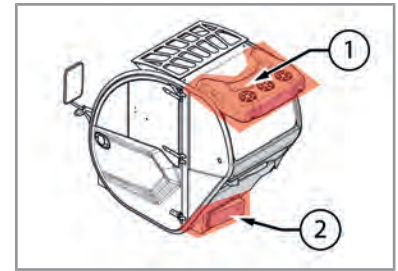

150993-1



CAUTION

Be careful not to damage the radiator fins while cleaning.

Check that the fins are not deformed; in that case straighten with caution.

11.18 Cylinder lock valves maintenance

The lock valves for cylinders prevent uncontrolled movement of the pistons of the cylinders in the event of hydraulic pressure failure or bursting of a hose.

The valves are installed directly on the cylinders.



DANGER

During the checking operations do not allow any person to stay within the radius of action of the vehicle.

Check the valves individually.

In case of malfunction do not use the vehicle until it has been repaired.

Boom lifting cylinders:

- Start the engine. Make sure that the parking brake is engaged and the transmission is in neutral.
- Lift the boom to approximately 45°.
- With the engine running at 1400 rpm, lower the boom. During the boom movement stop the engine.

The boom movement must slow down and then stop when the engine slows down and stops.



DANGER

If the boom continues to move after stopping the engine, the lifting cylinders lock valve is faulty.

Remove the fault as soon as possible, contact the **DIECI** service center.

Boom extension cylinder:

- Start the engine. Make sure that the parking brake is engaged and the transmission is in neutral.
- Lift and fully extend the boom.
- With the engine running at 1400 rpm, retract the boom. During the boom movement stop the engine.

The boom movement must slow down and then stop when the engine slows down and stops.



DANGER

If the boom continues to move after stopping the engine, the lifting cylinders lock valve is faulty.

Remove the fault as soon as possible, contact the **DIECI** service center.

Cylinder tilt forks:

- Start the engine, take a load on the forks (for example, a load of bricks or some bales of hay).
- Tilt the forks fully upward.
- Engage the parking brake and set the transmission into neutral.
- Swing the boom away from the ground sufficiently to allow the forks to tilt forward.
- With the engine running at 1400 rpm, operate the control lever to tilt the plate forward. During the forks movement stop the engine.

The swinging movement must slow down and then stop when the engine slows down and stops.



DANGER

If the boom continues to move after stopping the engine, the lifting cylinders lock valve is faulty.

Remove the fault as soon as possible, contact the **DIECI** service center.

Leveling cylinders and swinging lock (if any):

- Position the machine on a perfectly horizontal surface.
- Make sure that the parking brake is engaged and the transmission is in neutral.
- Make sure the vehicle is in carriage mode.
- Lift the boom about 15 cm from the ground and level the machine so that the chassis is perfectly parallel to the surface (check the level in the cab).
- Check that, without intervening on the leveling control, the machine maintains this position even after a prolonged use.



DANGER

If the boom continues to move after stopping the engine, the lifting cylinders lock valve is faulty.

Remove the fault as soon as possible, contact the **DIECI** service center.



NOTICE

Do not level the vehicle with boom raised and/or removed.

Outriggers cylinders (if present)

- Start the engine. Make sure that the parking brake is engaged and the transmission is in neutral.
- Place the vehicle on outriggers.

- Level the machine with the outriggers.
- Fully extend the boom.
- With the engine running at idle speed, rotate the machine turret.

**DANGER**

If the boom continues to move after stopping the engine, the lifting cylinders lock valve is faulty.

Remove the fault as soon as possible, contact the **DIECI** service center.

11.19 Differential Axles Maintenance

11.19.1 Differential axles oil: Check and replacement

The filler, level and drain caps are located in the central part of the front (fig. 150580-1) and rear (fig. 150580-2) differential axle:

When checking the oil level it is necessary to:

- Prepare the vehicle in the maintenance position.
- Place a container for the oil recovery under the level plug "1" to collect any leaks.
- Open the level cap "1". In the best conditions oil must seep out from the hole.
- If necessary top up to make oil seep out from the level cap "1".
- Put back the caps and tighten down.

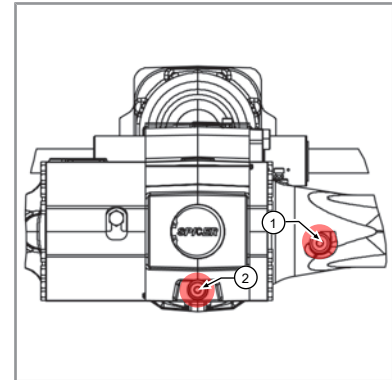

150580-1

When replacing the oil it is necessary to:

- Prepare the vehicle in the maintenance position.
- Place a container for the oil recovery under the drain plug "2" to collect any leaks.
- Open the level cap "1" and then the drain cap "2".
- Drain off all the oil
- Close the drain cap "2".
- Load new oil from the level cap of "1", up to make oil seep out.
- Put back the caps and tighten down.

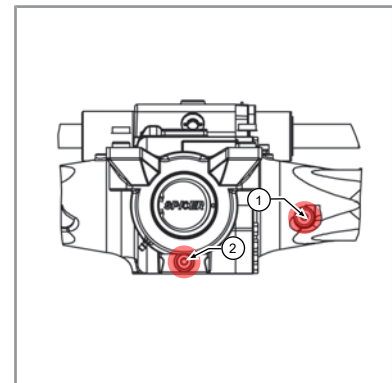

150580-2

11.20 Hydraulic fittings tightening torques

Inserts with 60° nose - BSP thread									
Thread	1/18.28	1/4.19	3/8-19	1/2-14	5/8-14	3/4-14	1"-11	1"1/4-11	121/2-11
(N·m)	12-14	14-16	25-28	45-60	55-70	90-110	120-140	170-190	200-245

Inserts with 60° nose - METRIC thread									
Thread	10x1	12x1.5	14x1.5	16x1.5	18x1.5	22x1.5	26x1.5	28x1.5	30x1.5
(N·m)	12-14	13-15	15-18	25-28	27-30	50-60	60-75	80-100	110-130

SERIES DIN RANGE „L“										
Thread	12x1.5	14x1.5	16x1.5	18x1.5	22x1.5	26x1.5	30.2	36x1.5	45x1.5	52x1.5
(N·m)	13-15	15-18	25-28	27-30	50-60	30-75	85-105	120-140	170-190	190-230

SERIES DIN RANGE „S“										
Thread	14x1.5	16x1.5	18x1.5	20x1.5	22x1.5	24x1.5	30x2	36x2	42x2	52x2
(N·m)	15-18	25-28	27-30	43-54	50-62	60-75	90-110	125-145	170-190	200-245

11.21 Bolts tightening torques

11.21.1 Bolts tightening torques: Fine pitch

	Coefficient of friction	4.8		5.8		6.8		8.8		10.9		12.9	
		Preload (N)	Tightening torque:(Nm)	Preload (N)	Tightening torque:(Nm)	Preload (N)	Tightening torque:(Nm)	Preload (N)	Tightening torque:(Nm)	Preload (N)	Tightening torque:(Nm)	Preload (N)	Tightening torque:(Nm)
M8	0.10	9798.1	10.87	12247.6	13.59	14697.1	16.31	19596.1	21.75	27557.1	30.58	33068.5	36.70
	0.14	9079.5	13.53	11349.4	16.91	13619.3	20.29	18159.1	27.05	25536.2	38.04	30643.4	45.65
M10	0.10	15296.9	21.13	19121.1	26.41	22945.3	31.69	30593.8	42.25	43022.5	59.42	51627.0	71.30
	0.14	14175.0	26.27	17718.8	32.84	21262.6	39.41	28350.1	52.55	39867.3	73.89	47840.8	88.67
M10	0.10	16383.6	22.12	20479.5	27.66	24575.4	33.19	32767.2	44.25	46078.8	62.23	55294.6	74.67
	0.14	15221.6	27.80	19027.0	34.75	22832.5	41.70	30443.3	55.61	42810.8	78.20	51373.0	93.84
M12	0.10	22020.7	35.83	27525.9	44.79	33031.0	53.75	44041.4	71.67	61933.2	100.78	74319.8	120.94
	0.14	20405.8	44.53	25507.2	55.66	30608.7	66.79	40811.6	89.06	57391.3	125.24	68869.5	150.29
M12	0.10	23333.7	37.26	29167.1	46.57	35000.6	55.88	46667.4	74.51	65626.1	104.78	78751.3	125.74
	0.14	21669.2	46.70	27086.5	58.38	32503.8	70.06	43338.4	93.41	60944.6	131.36	73133.5	157.63
M14	0.10	31610.0	59.04	39512.5	73.80	47415.0	88.57	63220.0	118.09	88903.1	166.06	106683.7	199.27
	0.14	29345.9	73.92	36682.4	92.40	44018.9	110.89	58691.9	147.85	82535.4	207.91	99042.5	249.49
M16	0.10	42581.3	89.78	53226.6	112.23	63871.9	134.67	85162.5	179.56	119759.8	252.51	143711.8	303.02
	0.14	39587.8	113.06	49484.7	141.32	59381.6	169.59	79175.5	226.12	111340.6	317.98	133608.7	381.57
M18	0.10	51457.2	124.03	64321.5	155.03	77185.8	186.04	102914.4	248.06	144723.3	348.83	173668.0	418.59
	0.14	47751.7	155.02	59689.6	193.78	71627.5	232.53	95503.3	310.05	134301.6	436.00	161161.9	523.20
M18	0.10	55415.1	130.17	69268.9	162.72	83122.7	195.26	110830.3	260.35	155855.1	366.12	187026.1	439.34
	0.14	51577.6	164.67	64472.0	205.84	77366.4	247.01	103155.2	329.35	145062.1	463.15	174074.5	555.77
M20	0.10	65534.1	173.72	81917.7	217.16	98301.2	260.59	131068.3	347.45	184314.8	488.60	221177.8	586.32
	0.14	60886.2	218.17	76107.8	272.71	91329.3	327.26	121772.4	436.34	171242.5	613.61	205491.0	736.33
M20	0.10	70114.7	181.58	87643.3	226.97	105172.0	272.36	140229.3	363.15	197197.5	51.68	236637.0	612.82
	0.14	65319.1	230.55	81648.8	288.19	97978.6	345.82	130638.1	461.10	183709.9	648.42	220451.9	778.10
M22	0.10	81220.8	236.88	101526.0	296.10	121831.2	355.32	162441.5	473.76	228433.4	666.23	274120.1	799.48
	0.14	75533.9	298.75	94417.4	373.43	113300.9	448.12	151067.8	597.49	212439.1	840.22	254927.0	1008.27

	Coefficient of friction	4.8		5.8		6.8		8.8		10.9		12.9	
		Preload (N)	Tightening torque:(Nm)	Preload (N)	Tightening torque:(Nm)	Preload (N)	Tightening torque:(Nm)	Preload (N)	Tightening torque:(Nm)	Preload (N)	Tightening torque:(Nm)	Preload (N)	Tightening torque:(Nm)
M22	0.10	86164.2	246.02	107705.3	307.53	129246.4	369.04	172328.5	492.05	242337.0	691.94	290804.3	830.33
	0.14	80331.8	313.41	100414.7	391.76	120497.7	470.11	160663.6	626.82	225933.2	881.46	271119.8	1057.75
M24	0.10	98515.6	308.56	123144.5	385.70	147773.4	462.84	197031.1	617.12	277075.0	867.83	332490.0	1041.40
	0.14	91693.3	390.33	114616.6	487.92	137539.9	585.50	183386.5	780.67	257887.3	1097.82	309464.8	1317.38
M24	0.10	104079.4	319.62	130099.2	399.52	156119.0	479.43	208151.7	639.23	292723.2	898.92	351267.9	1878.71
	0.14	97096.0	408.12	121370.1	510.15	145644.1	612.18	194192.1	816.24	273082.6	1147.84	327699.1	1377.41
M27	0.10	127922.3	448.43	159902.9	560.54	191883.5	627.65	255844.7	896.87	359781.6	1261.22	431737.9	1513.46
	0.14	119185.0	569.67	148981.3	712.09	178777.5	854.51	238370.1	1139.34	335207.9	1602.20	402249.5	1922.64
M30	0.10	16817.5	623.80	201021.8	779.75	241226.2	935.70	321635.0	1247.60	452299.2	1754.43	542759.0	2105.32
	0.14	149957.0	795.14	187446.3	993.93	224935.5	1192.72	299914.0	1590.29	421754.2	2236.34	506105.0	2683.61

11.21.2 Bolts tightening torques: Coarse pitch

	Coefficient of friction	4.8		5.8		6.8		8.8		10.9		12.9	
		Preload (N)	Tightening torque:(Nm)	Preload (N)	Tightening torque:(Nm)	Preload (N)	Tightening torque:(Nm)	Preload (N)	Tightening torque:(Nm)	Preload (N)	Tightening torque:(Nm)	Preload (N)	Tightening torque:(Nm)
M3	0.10	1219.9	0.54	1524.9	0.68	1829.9	0.82	2439.9	1.09	3431.0	1.53	4117.2	1.84
	0.14	1125.9	0.60	1407.4	0.83	1688.9	1.00	2251.9	1.34	3166.7	1.88	3800.0	2.26
M3.5	0.10	1638.2	0.84	2047.8	1.05	2457.3	1.26	3276.4	1.68	4607.5	2.36	5528.9	2.84
	0.14	1511.3	1.03	1889.2	1.28	2267.0	1.54	3022.6	2.05	4250.6	2.89	5100.7	3.47
M4	0.10	2115.4	1.25	2644.3	1.56	3173.1	1.88	4230.8	2.50	5949.6	3.52	7139.5	4.22
	0.14	1950.9	1.53	2438.7	1.91	2926.4	2.29	3901.9	3.06	5487.0	4.30	6584.4	5.16
M5	0.10	3461.6	2.46	4327.0	3.08	5192.3	3.70	6923.1	4.93	9735.7	6.93	11682.8	8.32
	0.14	3196.8	3.02	3996.0	3.78	4795.2	4.53	6393.7	6.04	8991.1	8.50	10789.3	10.20
M6	0.10	4874.7	4.24	6093.4	5.30	7312.1	6.35	9749.4	8.47	13710.1	11.92	16452.2	14.30
	0.14	4499.1	5.19	5623.9	6.48	6748.6	7.78	8998.2	10.37	12653.7	14.59	15184.4	17.51
M7	0.10	7134.5	6.97	8918.2	8.71	10701.8	10.45	14269.1	13.94	20065.9	19.60	24079.1	23.52
	0.14	6599.6	8.60	8249.5	10.76	9899.4	12.90	13199.2	17.21	18561.4	24.20	22273.6	29.04
M8	0.10	8947.1	10.20	11183.9	12.75	13420.7	15.30	17894.2	20.41	25163.7	28.70	30196.5	34.44
	0.14	8265.6	12.54	10332.0	15.67	12398.4	18.80	16531.2	25.07	23247.0	35.26	27896.5	42.31
M10	0.10	14244.5	20.11	17805.6	25.14	21366.8	30.16	28489.0	40.22	40062.7	56.56	48075.3	67.87
	0.14	13167.4	24.76	16459.2	30.95	19751.1	31.14	26334.8	49.52	37033.3	69.64	44439.9	83.56
M12	0.10	20766.6	34.43	25958.3	43.03	31149.9	51.64	41533.2	68.86	58406.1	96.83	70087.3	116.20
	0.14	19204.0	42.42	24005.0	53.03	28806.0	63.63	38408.0	84.84	54011.2	119.31	64813.5	143.17
M14	0.10	28389.9	54.77	35487.4	68.46	42584.9	82.15	56779.8	109.53	79846.6	154.03	95816.0	184.84
	0.14	26261.2	67.56	32826.5	84.45	39391.8	101.34	52522.4	135.13	73859.6	190.02	88631.5	228.03
M16	0.10	39242.1	85.14	49052.7	106.43	58863.2	127.72	78484.3	170.29	110368.5	239.47	132442.2	287.36
	0.14	36364.2	105.80	45455.3	132.26	54546.3	158.71	72728.5	211.61	102274.4	297.58	122729.3	357.09
M18	0.10	47533.0	117.48	59416.3	146.85	71299.6	176.22	95066.1	234.96	133686.7	330.41	160424.1	396.49
	0.14	43986.1	145.16	54982.7	181.45	65979.2	217.74	87972.3	290.32	123711.0	402.26	148453.2	489.92
M20	0.10	61238.0	166.08	76547.5	207.61	91857.0	249.13	122476.0	332.17	172231.9	467.11	206678.2	560.54
	0.14	56747.1	206.39	70933.9	257.98	85120.6	309.58	113494.2	412.78	159601.2	580.47	191521.5	696.56
M22	0.10	76305.2	227.22	95381.5	284.02	114457.8	340.82	152610.4	454.43	214608.3	639.05	257530.0	766.85
	0.14	70791.9	283.79	88489.8	352.74	106187.8	425.69	141583.7	567.58	199102.1	798.16	238922.5	957.80
M24	0.10	88232.4	287.16	110290.5	358.94	132348.6	430.73	176464.9	574.31	248153.7	807.63	297784.4	969.15
	0.14	81761.8	356.84	102202.2	446.05	122642.7	535.26	163523.6	713.68	229955.1	1003.61	275946.1	1204.33

	Coefficient of friction	4.8		5.8		6.8		8.8		10.9		12.9	
		Preload (N)	Tightening torque:(Nm)	Preload (N)	Tightening torque:(Nm)	Preload (N)	Tightening torque:(Nm)	Preload (N)	Tightening torque:(Nm)	Preload (N)	Tightening torque:(Nm)	Preload (N)	Tightening torque:(Nm)
M27	0.10	115778.8	420.40	144723.5	525.05	173668.2	930.06	231557.6	840.08	325627.9	1181.36	390753.4	1417.63
	0.14	107441.5	525.08	134301.9	656.35	161162.2	787.62	214883.0	1050.16	302179.2	1476.79	362615.0	1772.15
M30	0.10	140999.5	572.83	176249.4	716.03	211499.3	859.24	281999.0	1145.65	396561.1	1611.08	475873.4	1933.29
	0.14	130770.6	714.49	163463.3	893.11	196155.9	1071.73	261541.2	1428.97	367792.3	2009.49	441350.8	2411.39

12 Technical assistance service

Local Dealers can supply original spare parts as well as advice and instructions for their installation and use.

Use only original spare parts when they are required.

The use of non-original spare parts may cause damage to other parts of the vehicle. Customers are advised to purchase all original spare parts required only from an authorized Agent or Dealer.

DIECI s.r.l. does not consider itself liable for damage deriving from the use of non-original spare parts.

12.1 Spare parts supply

DIECI s.r.l. guarantees the supply of original spare parts or alternatives for 10 years from the date of the last model produced of the series concerned.

12.2 Assistance to owner / operator

In order to obtain a good service from your Dealer, please obtain of these fundamental data before contacting the service center:

1. Specify your name, address and telephone number.
2. Indicate the model and serial number of the machine chassis.
3. Indicate the date of purchase and the hours of operation.
4. Explain the nature of the fault.

Note that only DIECI Dealers can access the resources at DIECI site for customer service. Moreover, they are able to offer a variety of programs with regard to warranty, maintenance at a fixed price, safety checks, including tests

12.3 Technical Assistance Service address

Dieci Technical Assistance Service

Via E. Majorana, 2/4

42027 Montecchio Emilia (RE) ITALY

Tel. +39 0522 869611

Fax +39 0522 869744

service@dieci.com

13 Problems diagnostics



WARNING

The interventions for the elimination of faults can only be carried out by trained personnel.

Do not work on failures if the "Safety regulations", "Safe Working Procedures" and "MAINTENANCE" have not been read and understood before.



This symbol indicates that the trouble experienced may NOT be resolved without the intervention of a **DIECI** Service authorized workshop

13.1 Engine



TROUBLE	CAUSE	SOLUTION	
It does not set in motion	Direction of travel lever engaged	Place the lever in neutral	
	Operator not properly seated in the driver's seat	Sit properly in cab	
	No fuel	Fill the tank	
	Battery cut-off switch disconnected	Connect the battery cut-off switch	
	Low Battery	Recharge the battery or replace it	
	Fuse failure	Replace the fuse	
	Other	Consult the Use and Maintenance manual of the engine	

13.2 Hydraulic transmission system



TROUBLE	CAUSE	SOLUTION	
The vehicle does not go in any direction	Insufficient hydraulic oil level	Check the hydraulic oil level	
	Electronic accelerator entered (if installed)	Disconnect the electronic accelerator	
	The sensor built-in the seat does not report the presence of the operator	Sit properly at the driver's seat	
	The movement selection lever is not engaged	Engage the lever to the desired position	
	The outriggers are lowered (if installed)	Raise all outriggers fully up	
	Rear axle locked (if installed)	Release the axle	
	Parking brake in operation	Disengage the brake	
	Electrical circuit failure	Repair the circuit	
	Hydrostatic transmission failure	Repair or replace the transmission	
The ByPass valve for the machine towing was closed	Open the ByPass valve		

TROUBLE	CAUSE	SOLUTION	
The vehicle loses speed	Hydraulic oil suction filter clogged	Remove the oil filter and replace it	
	Hydrostatic transmission failure	Repair or replace the transmission	
	Inching pedal failure	Check the correct operation of the pedal	



13.3 Brakes

TROUBLE	CAUSE	SOLUTION	
The vehicle does not brake	Lack of oil in the oil - brakes tank	Refill the tank and / or Purge the system	
	Loss of fluid from the circuit	Check for leaks	
	Brake discs worn	Replace the pads	
	Brakes pump failure	Repair or replace	
	Unsuitable fluid in the circuit or in the differential sump	Check the brake oil specifications indicated	

13.4 Steering wheel

TROUBLE	CAUSE	SOLUTION	
The machine runs sideways The wheels are not aligned	The wheels are not correctly aligned	Align them	
	Steering selection error	Put back the lever in a different steering mode	
	Control distributor failure	Repair or replace the distributor	
	Leakage from the steering wheel hydraulic cylinders	Replace the gaskets	

13.5 Telescopic boom

TROUBLE	CAUSE	SOLUTION	
The vehicle does not lift the load	They safety systems have activated	See the "Anti-tipping device" chapter	
	Electrical system failure	Check the fuses and electrical system	
	Hydraulic oil level in the tank insufficient	Top up	
	Relative hydraulic pump failure	Repair or replace the pump	
	Distributor low calibration	Check and re-calibrate the distributor	

TROUBLE	CAUSE	SOLUTION	
	Lifting cylinders internal leak	Replace the gaskets	
The boom does not extend	"The safety systems have activated (Indicator light and audible alarm in operation)"	See the "Anti-tipping device" chapter	
The boom does not come down	"The safety systems have activated (Indicator light and audible alarm in operation)"	See the "Anti-tipping device" chapter	

14 Cleaning

Cleaning the vehicle and all its components is fundamental for it to be kept in proper working order.

14.1 Machine cleaning

Proceed as follows for a correct cleaning process:

- Switch the engine off, remove the ignition key and wait until the various components cool down.
- Wear the suitable protective clothing (gloves, masks, overalls, etc.).
- Do not use flammable liquids, acids or products that may chemically attack the vehicle components.
- Use water to soften dirt that sticks to the surface.
- Ask your **DIECI** dealer for touch-up paint to repair minor defects in the vehicle bodywork.
- Check that all the safety stickers are present. Replace any that have been lost or removed for cleaning purposes.
- Use a pressure washer to clean the external part of the vehicle and the engine compartment, bearing the following in mind:
 - Make sure the top-up caps (radiator, oil tank, fuel tank, etc.) are closed well.
 - Protect the control boxes and connectors from water infiltrations.
 - Do not operate with a pressure and water temperature that exceeds 100 bar and 80°, respectively.
 - Hold the washer nozzle at a minimum distance of 40 cm from the relative surface.
 - Do not direct the jet at any single point but wash with wide strokes.
 - The inside of the vehicle is delicate and cannot be cleaned with a pressure washer.

Electrical components

- If a pressurized jet is used, try not to wet the electrical components, such as the alternator and the starter motor.
- If water accidentally falls into the electrical system, it could cause the vehicle to malfunction.
- Do not use water or steam to clean the electrical system, sensors and connectors.

Mechanical Components

- Do not clean the moving elements or hot surfaces, allow all parts to cool as a temperature change could damage them.

14.2 Glasses cleaning

- The cab windows, lights and rear view mirrors must be washed often with soapy water.
- After washing has been completed, dry thoroughly; do not leave any stains or marks which may limit or obstruct the driver's visibility.

14.3 Cleaning the cab

- Clean soft upholstery in the cab with a cloth that has been dipped in a solution of water and detergent and then thoroughly wrung.
- The driver's seat and the floor must be cleaned with a vacuum cleaner and/or a stiff brush. If necessary, use a damp cloth to remove any stubborn stains.
- Clean the seat belt with a sponge that has been soaked in hot soapy water, and let it dry on its own.

- Fabric-covered seats must be cleaned with a stiff brush or vacuum cleaner. Plastic seats must be cleaned with a damp cloth.

**WARNING****Pay attention to electrical components.**

Do not use water jets inside the cab.

**WARNING**

Do not use products containing alcohol to clean the interior lining of the cab.

14.4 Safety stickers cleaning

**CAUTION**

To ensure proper interpretation verify that they are in the correct position and that they are always kept clean.

Clean the safety stickers when they are dirty, covered with mud, concrete or debris.

**WARNING**

It is absolutely forbidden to clean the messages on the vehicle using solvents or gasoline.

The stickers may become discolored. The stickers in addition to those of care and safety must always be treated in the same way.

15 Lifting the vehicle



DANGER

Always check the good condition of the anchors (ropes, chains, wedges, etc...).

Make sure that the lifting equipment is adequate for the weight of the vehicle to be lifted.

The weight of the vehicle is shown on a special riveted metal plate; check the overall dimensions for the maximum and minimum height values from the ground and the weight allowed.

The vehicle is fitted with lifting points, marked by special symbols (fig. 150522-1).

Attach the ropes at the points indicated in the figure, paying utmost attention during the lifting phases. Slowly proceed with the lifting.

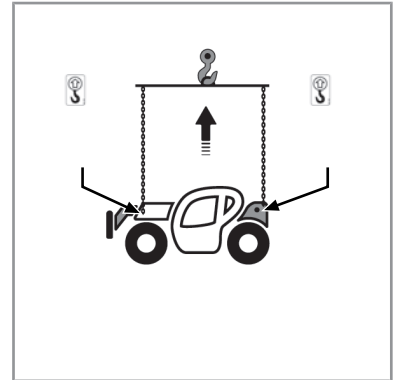

150522-1



DANGER

Before lifting the vehicle, make sure no unauthorized personnel are in the surrounding area.



CAUTION

Lifting cables with a minimum unit capacity of 6 tons (13220 lb) are required.

Before lifting the vehicle, make sure to:

- Remove any attachments installed on the vehicle.
- Retract and lower the telescopic boom completely.
- Engage the parking brake, place and the movement selection lever at "N" and switch off the vehicle.
- Close all windows and the cab door.

16 Transporting the vehicle on a trailer



WARNING

Always check the good condition of the anchors (ropes, chains, wedges, etc...).

Pay attention to the following when loading the vehicle onto a trailer:

- Before using ramps or trailers to load the vehicle on, remove any mud, ice or oil that could cause accidents.
- Check that the axle and the transport vehicle can withstand the overall weight of the machine and any loaded equipment.
- Check the overall dimensions of the vehicle for minimum and maximum heights from the ground and the weight allowed.
- Carefully handle the vehicle onto the transport vehicle.
- Make sure local regulations are observed when transporting the vehicle on public roads.



150526-1



DANGER

When loading or unloading a vehicle from a transport vehicle, there is always the risk of the vehicle overturning sideways; therefore, have another person on the ground to control the operations.

Take the following precautions when loading or unloading a vehicle:

1. Choose solid and level ground.
2. Remove any attachments installed on the vehicle.
3. Lower and fully retract the telescopic boom
4. Use a platform or a ramp.
5. Always select the slowest speed.
6. Load the vehicle on to the transport vehicle, making sure that the ramps are positioned properly and safely.
7. Once the vehicle is in a safe position, switch the engine off and engage the parking brake.
8. Close all windows and the cab door.
9. Anchor the vehicle to the transport vehicle with chains or cables through the relative hooks (fig. 150526-2).
10. Apply wedges to the front and rear wheels of the transport vehicle.

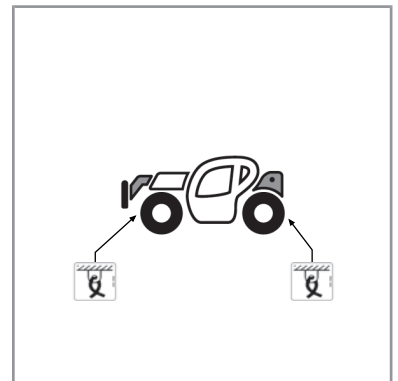

150526-2

17 Storing the vehicle

17.1 Long period of inactivity

If the vehicle must be stored for a long period of time (over a week), certain precautions must be complied with to protect it:

- Clean the vehicle.
- Lubricate all the greasers.
- Check the tires and inflate them to the recommended pressure.
- Clean the fuel system and change the filter cartridges.
- Store any equipment.
- Use the battery cut-off switch to deactivate the electrical circuit.
- Realign and lower all the mobile parts of the vehicle completely.
- Close and lock all the windows.
- Close and lock the door.

17.2 Long period of inactivity

If the machine must be stored for a long period (more than two months), certain precautions must be complied with to protect it:

- Clean the vehicle.
- Touch up the paint where necessary to prevent rust.
- Lubricate all the greasers.
- Check whether any parts are worn or damaged and replace them, if necessary.
- Check the tires and inflate them to the recommended pressure.
- Drain the oil from the engine and replace it with new oil.
- Clean the fuel system and change the filter cartridges.
- Empty the fuel tank as usual and fill it with ten liters of special fuel for prolonged inactivity. Run the engine for ten minutes so the new solution can distribute evenly.
- Store any equipment.
- Use the battery cut-off switch to deactivate the electrical circuit.
- Realign and lower all the mobile parts of the vehicle completely.
- Apply a layer of light grease on the uncovered rods of the hydraulic cylinders.
- Cover the exhaust opening.
- Close and lock all the windows.
- Close and lock the door.

17.3 Restarting the vehicle

Preparing the vehicle after a long period of inactivity:

- Inflate the tires to the correct pressure.
- Remove the jack stands from under the axles.
- Fill the fuel tank.
- Check the radiator coolant level.
- Check the level of the various oils.

- Fit a fully charged battery.
- Remove the cover of the exhaust pipe.
- Remove the layer of grease on the exposed cylinder rods.
- Start the engine and check that all the controls work properly.
- Let the engine run for a few minutes.
- Verify the efficiency of the brake system.

18 WASTE DISPOSAL

- Waste material should not be dispersed in the environment but rather disposed of appropriately. Used lubricants, batteries, rags dirty with grease, brake pads etc. should be handed over to specialized companies authorized to dispose of polluting waste.
- Improper waste disposal poses a threat to the environment. The following are potentially dangerous waste: lubricants, fuel, cooling, filters and batteries.
- Do not spill or pour waste onto the ground, into the sewers or into water beds.
- Contact your local authority or collection centers for information for how to recycle or dispose of waste properly.

18.1 Ecological considerations

A few helpful recommendations are listed below. Learn about current legislation in force in your country.

Ask suppliers for information about lubricating oils, fuels, antifreeze products, detergents, etc., about their effects on people and on the environment as well as on information regarding the regulations to be observed when using, stocking and disposing of such products.

- Do not refill the tanks using unsuitable jerry cans or pressurized combustible fueling systems as they may cause leaks and loss of significant amounts of liquid.
- Modern lubricating oils contain additives. Do not burn contaminated combustible oils and/or oils used in conventional heating systems.
- Take care not to spill used engine cooling fluids, engine and transmission lubricating oils, hydraulic oil, brake oil etc. while pouring or draining them. Store them safely and, when it is time, dispose of them in compliance with current legislation or with local facilities.
- Modern antifreeze liquids and their solutions, such as antifreeze and other additives should be replaced every two years. Make sure such liquids are not absorbed by the soil; they should be collected and disposed of appropriately.
- Do not intervene directly with the air conditioning systems (Optional), by opening them. These systems contain gas which must not be released into the atmosphere. Contact your dealer or an expert who has the necessary special equipment and who would, in any case, have to refill the system.
- Immediately repair any leaks or faults in the cooling or engine hydraulic systems.

18.2 Protect the environment

It is illegal to pollute sewers, water sources or soil. Use only authorized dumping grounds centers, including the areas designated by the local authorities or workshops equipped with the necessary tools for the disposal of used oils. If in doubt, contact your local authority for relevant instructions.

19 Demolition

To demolish the vehicle or the equipment, dismantle all components and keep the different types of materials separate for sending to the relative collection centers.

The following types of materials may be present:

- Ferrous materials (carpentries and mechanical components)
- Plastic materials (gaskets, belts, protections)
- Electric materials (cables, windings and similar)
- Oils and lubricants (hydraulic oil, reduction gear lubricants, lubricating greases)

20 Wiring diagram

20.1 Components legend

Name	Description	Sheet
A101	TOOL	1
A101	TOOL	2
A101	TOOL	3
A101	TOOL	4
A101	TOOL	4
A101	TOOL	5
A101	TOOL	8
A149	RIGHT LOUDSPEAKER	9
A151	RADIO	9
A159	RIGHT LOUDSPEAKER	9
A233	ACCELERATOR PEDAL	6
A241	SARL CONTROL UNIT	6
A241	SARL CONTROL UNIT	3
A283	CAN LINK	3
A744	ECU ENGINE SIDE KUBOTA	3
A744	ECU ENGINE SIDE KUBOTA	4
A745	ECU VEHICLE SIDE KUBOTA	1
A745	ECU VEHICLE SIDE KUBOTA	2
A745	ECU VEHICLE SIDE KUBOTA	3
A745	ECU VEHICLE SIDE KUBOTA	3
A745	ECU VEHICLE SIDE KUBOTA	4
A745	ECU VEHICLE SIDE KUBOTA	1
A747	ENGINE INTERMEDIATE CONNECTOR	3
A747	ENGINE INTERMEDIATE CONNECTOR	3
A747	ENGINE INTERMEDIATE CONNECTOR	4
A748	INJECTOR INTERMEDIATE CONNECTOR	3
A749	DPF INTERMEDIATE CONNECTOR	4
A754	DIAGNOSTIC ENGINE KUBOTA	3
B130	SEAT MICROSWITCH	1
B139	STOP LIGHTS MICROSWITCH	8
B181	TRANSMISSION DISCONNECT MICROSWITCH	2
B503	HORN	8
B512	DIESEL LEVEL SENSOR	4
B513	CLOGGED HYDRAULIC OIL FILTER PRESSURE SENSOR	4
B544	EXTENSION SENSOR	7
B554	NEGATIVE BRAKE PRESSURE SWITCH	2
B558	FRONT AXLE ALIGNMENT PROXIMITY SWITCH	5
B559	AXLE LOAD CELL	6
B560	REAR AXLE ALIGNMENT PROXIMITY SWITCH	5

Name	Description	Sheet
B585	SPEED SENSOR	4
B638	CLOGGED AIR FILTER SENSOR	4
B643	CLOSED BOOM MICROSWITCH	6
B688	DIESEL DECANTING SENSOR	4
B746	AIR FLOW SENSOR	3
B762	30° BOOM MICROSWITCH	7
B763	15° BOOM MICROSWITCH	7
E102	RIGHT FRONT WORK LIGHT	9
E103	RIGHT REAR WORK LIGHT	9
E104	LEFT FRONT WORK LIGHT	9
E118	LEFT REAR WORK LIGHT	9
E127	ROTATING LIGHT	9
E147	COURTESY LIGHT	9
E522	RIGHT REAR HEADLIGHT	8
E524	PLATE LIGHT	8
E526	LEFT FRONT LIGHT	8
E548	LEFT REAR HEADLIGHT	8
E551	RIGHT FRONT LIGHT	8
F1	OUTRIGGERS CONSENT RELAY FUSE	5
F10	FUSE +15 SERVICES LIGHTING SWITCHES	2
F11	FRONT SIDELIGHTS FUSE RIGHT AND REAR LEFT	8
F12	LICENSE PLATE LIGHTS AND HEADLIGHTS FUSE	8
F14	ANTI-TIPPING SYSTEM FUSE	6
F15	FUSE +15 RADIO CONTROL SWITCH AND ROTATING LAMP	1
F16	STOP LIGHTS MICROSWITCH FUSE	8
F17	BOOM LIGHTS SWITCH FUSE	9
F18	FUSE NOT USED	11
F19	FUSE +15 BASKET KEY	1
F2	FUSE +30 WARNING	8
F20	FUSE NOT USED	11
F21	WINCH RELAY FUSE	6
F22	WORK LIGHTS RELAY FUSE	9
F23	FUSE +30 COLUMN SWITCH - LIGHTS AND OVERHEADLIGHT SWITCH	8
F24	RIGHT REAR WORK LIGHT FUSE	9
F25	FUSE + 30 ALGA TOOL	4
F26	FUSE NOT USED	11
F27	REVERSE GEAR LIGHT AND BUZZER FUSE	2
F28	LEVELLING + OUTRIGGERS STABILIZATION FUSE	7
F29	BOOM SUSPENSION AUX PUMP FUSE	7
F3	LOW BEAM LIGHTS FUSE	8
F31	TRANSMISSION DISCONNECT FUSE	2
F32	SUPPLY RELAY FUSE UDCI DANFOSS	7
F33	FAN SPEED FUSE	10

Name	Description	Sheet
F34	OPTIONAL SUPPLIES FUSE	11
F35	FRONT ELECTRIC WINDOW MOTOR FUSE	8
F36	FUSE + 15 REAR ELECTRIC WINDOW-RADIO-ANTENNA	9
F37	SUPPLY +15 MC2M AND TOOL FUSE	4
F38	TRAILER AND SV AND SELECTOR BUTTON FUSE	5
F39	SENSORS + WINCH FUSE	4
F4	POWER SOCKET FUSE	9
F40	RADIATOR AND BOOM HEAD SV FUSE	4
F41	ENGINE STOP FUSE	1
F42	SEAT MICROSWITCH FUSE, SEAT TEMP. START-UP SAFETY	1
F43	INCHING MICROSWITCH FUSE	1
F5	HIGH BEAM LIGHTS FUSE	8
F50	FUSE VP MC2M	6
F51	EVAPORATOR FAN FUSE	10
F540	CAB MAIN +30 FUSE	1
F541	START FUSE	1
F6	RIGHT FRONT WORK LIGHT FUSE	9
F7	LEFT FRONT WORK LIGHT FUSE	9
F750	KUBOTA MAIN FUSE	1
F751	EGR VALVE FUSE	1
F752	ECU 50 STARTER FUSE	1
F755	CAB MAIN +30 FUSE	1
F8	HORN RELAY FUSE	8
FG1	ALTERNATOR FUSE	1
FG2	PRE HEATING FUSE	1
G0	BATTERY	1
G529	ALTERNATOR	1
H296	KUBOTA ENGINE MECH. PREHEATING INDICATOR LIGHT	1
H502	REVERSE GEAR BUZZER	8
K1	STARTER ANTI-RESTART CONTROL UNIT	1
K10	OUTRIGGERS CONSENT RELAY	5
K11	STARTUP FROM BASKET RELAY	1
K12	SERVICES CONSENT RELAY	1
K13	30° BOOM CONSENT RELAY	5
K14	EXTENSION RELAY CONSENT RELAY	5
K15	NEUTRAL GEAR RELAY	2
K153	SERVICES RELAY	1
K16	TIMER CONTROL UNIT RELAY	2
K17	ENGINE STOP RELAY	1
K18	RIGHT REAR WORK LIGHT RELAY	9
K19	LEFT REAR WORK LIGHT RELAY	9
K2	TIMER CONTROL UNIT	2
K20	WINCH RELAY	6

Name	Description	Sheet
K21	BASKET WARNING LIGHT CONSENT RELAY	7
K22	30° BOOM CONSENT RELAY	7
K23	SUPPLY RELAY UDCI DANFOSS	7
K24	TRANSMISSION DISCONNECT RELAY	2
K25	2nd PUMP AND DEADMAN RELAY	7
K26	LOW BOOM RELAY	7
K27	30° BOOM RELAY CONSENT RELAY	7
K28	AUX PUMP SV RELAY	7
K29	REVERSING LIGHTS AND REVERSING BUZZER RELAY	2
K3	S. CUT-OFF 1 SARL	7
K30	FORWARDS GEAR RELAY	2
K302	NEGATIVE NEUTRAL SIGNAL RELAY	2
K31	REVERSE GEAR RELAY	2
K4	S. CUT-OFF 2 SARL	7
K5	HORN RELAY	8
K530	STARTUP RELAY	1
K531	PREHEATING RELAY	1
K6	LEFT FRONT WORK LIGHT RELAY	9
K7	RIGHT FRONT WORK LIGHT RELAY	9
K753	MAIN RELAY	1
K8	HIGH BEAM LIGHTS RELAY	8
K9	LOW BEAM LIGHTS RELAY	8
M112	FRONT WINDOW WIPER MOTOR	8
M117	FRONT WINDOW WASHER	8
M119	REAR WINDOW WASHER	8
M122	REAR WINDOW WIPER MOTOR	9
M129	HEATING MOTOR	10
M152	PNEUMATIC SEAT	8
M520	STARTER MOTOR	1
M555	AIR CONDITIONED COMPRESSOR	10
M646	FUEL PUMP	4
R1	PREHEATING GLOW PLUGS	1
S0	BATTERY CUT-OFF SWITCH	1
S106	REAR WORK LIGHTS SWITCHES	9
S108	WARNING SWITCH	8
S111	SV SWITCH BOOM HEAD	5
S115	ROTATING LIGHT SWITCH	9
S121	PARKING BRAKE SWITCH	2
S131	REAR SV SELECTOR	5
S132	TRAILER BUTTON	5
S136	WHEELS ALIGNMENT SWITCH	5
S137	COLUMN SWITCH	2
S140	LIGHT SWITCH	8

Name	Description	Sheet
S141	STARTER PANEL	1
S146	KEY FOR OPERATIONS RESTORING	6
S148	FRONT WORK LIGHTS SWITCH	9
S169	BOOM SUSPENSION SWITCH	8
S197	FRONT WIPER SWITCH	9
S204	MUSHROOM-HEAD EMERGENCY PUSHBUTTON	1
S206	BOOM WORK LIGHT SWITCH	9
S295	INHIBIT/FORCED REGENERATION SWITCH	1
S303	QUICK COUPLING SWITCH	5
S332	REAR WINDOW WASHER SWITCH	9
W177	ANTENNA	9
X154.p	BASKET LINE INTERFACE CONNECTOR	1
X165	POWER POINT	9
X178.s	OPTIONAL POWER SUPPLY	11
X283	CAN BUS NODE	3
X284	CAN BUS NODE	3
X285	CAN BUS NODE	3
X286	CAN BUS NODE	3
X300.p	CHASSIS LINE INTERFACE CONNECTOR	5
X322.s	DISTRIBUTOR CONTROL UNIT LINE INTERFACE	6
X323.s	DISTRIBUTOR CONTROL UNIT LINE INTERFACE	6
X324.s	DISTRIBUTOR CONTROL UNIT LINE INTERFACE	6
X324.s	DISTRIBUTOR CONTROL UNIT LINE INTERFACE	3
X333.s	AIR CONDITIONED KIT	10
X587.p	TRAILER SOCKET INTERFACE	8
Y523	PARKING BRAKE SOLENOID VALVE	2
Y527	FORWARD GEAR SOLENOID VALVE	2
Y528	REVERSE GEAR SOLENOID VALVE	2

20.2 Wiring diagram sheets

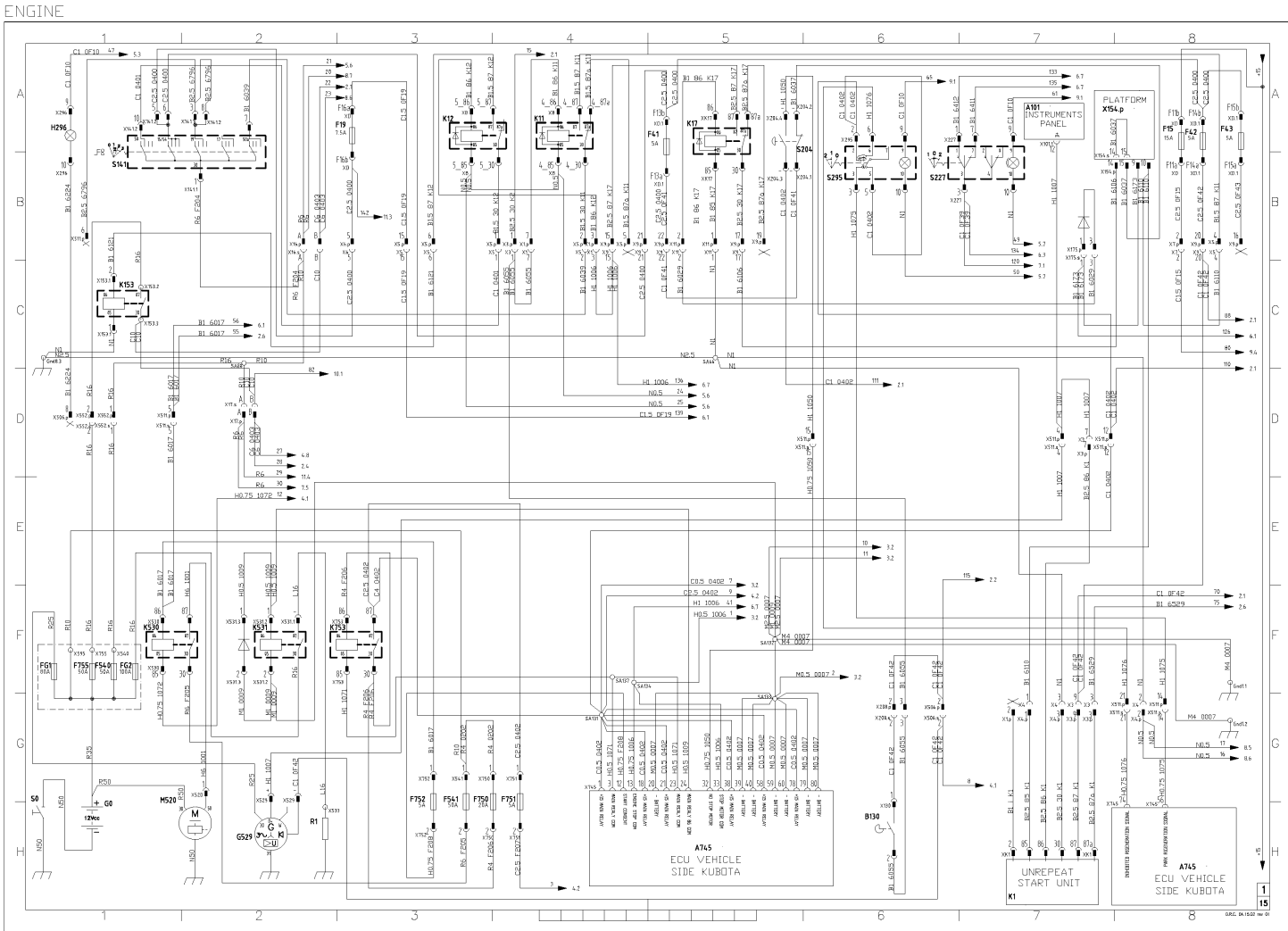

Illustration 8: Wiring diagram - APOLLO KE - 20150914_Page_01

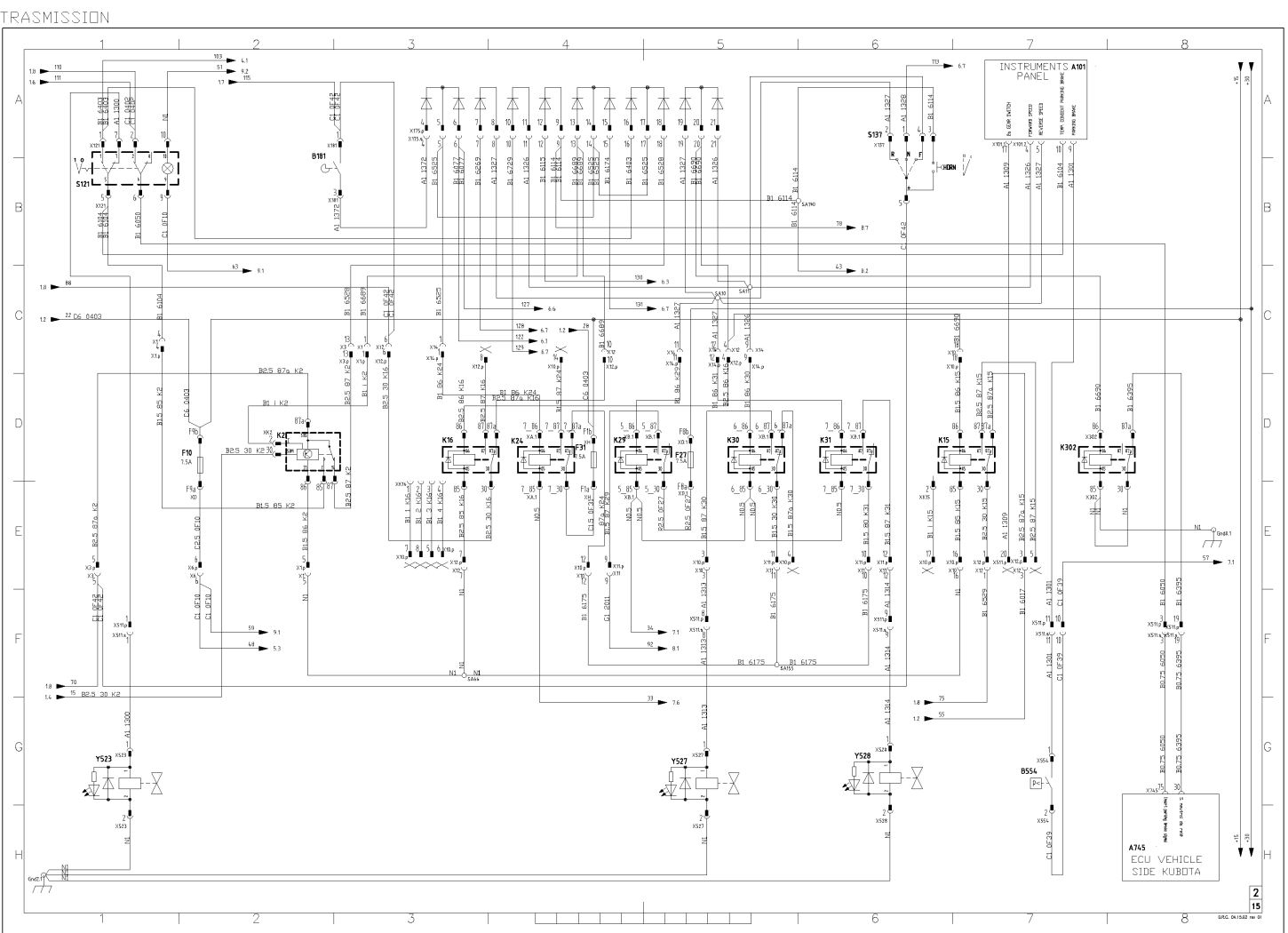

Illustration 9: Wiring diagram - APOLLO KE - 20150914_Page_02

CAN-BUS AND DIAGNOSTIC

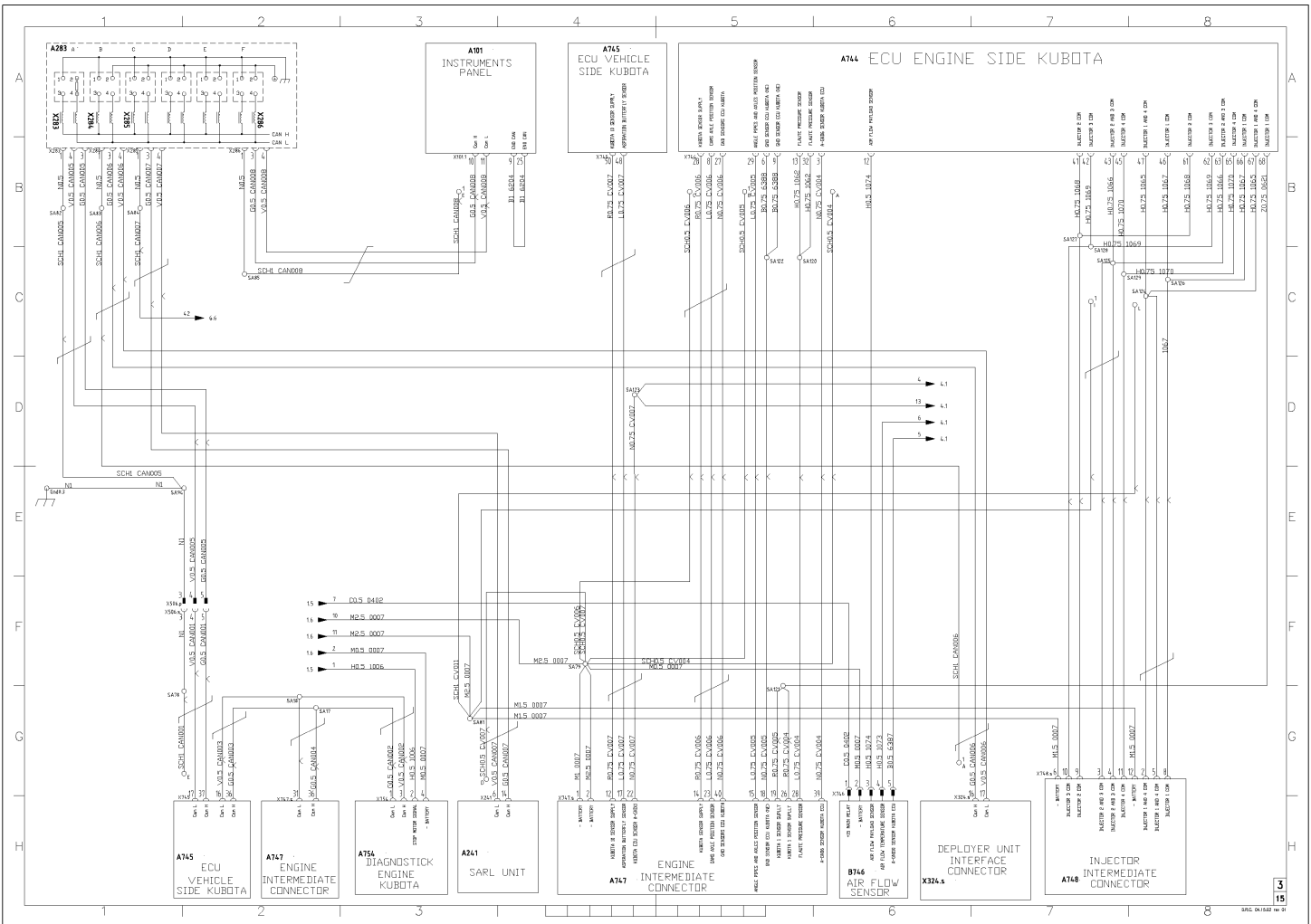

Illustration 10: Wiring diagram - APOLLO KE - 20150914_Page_03

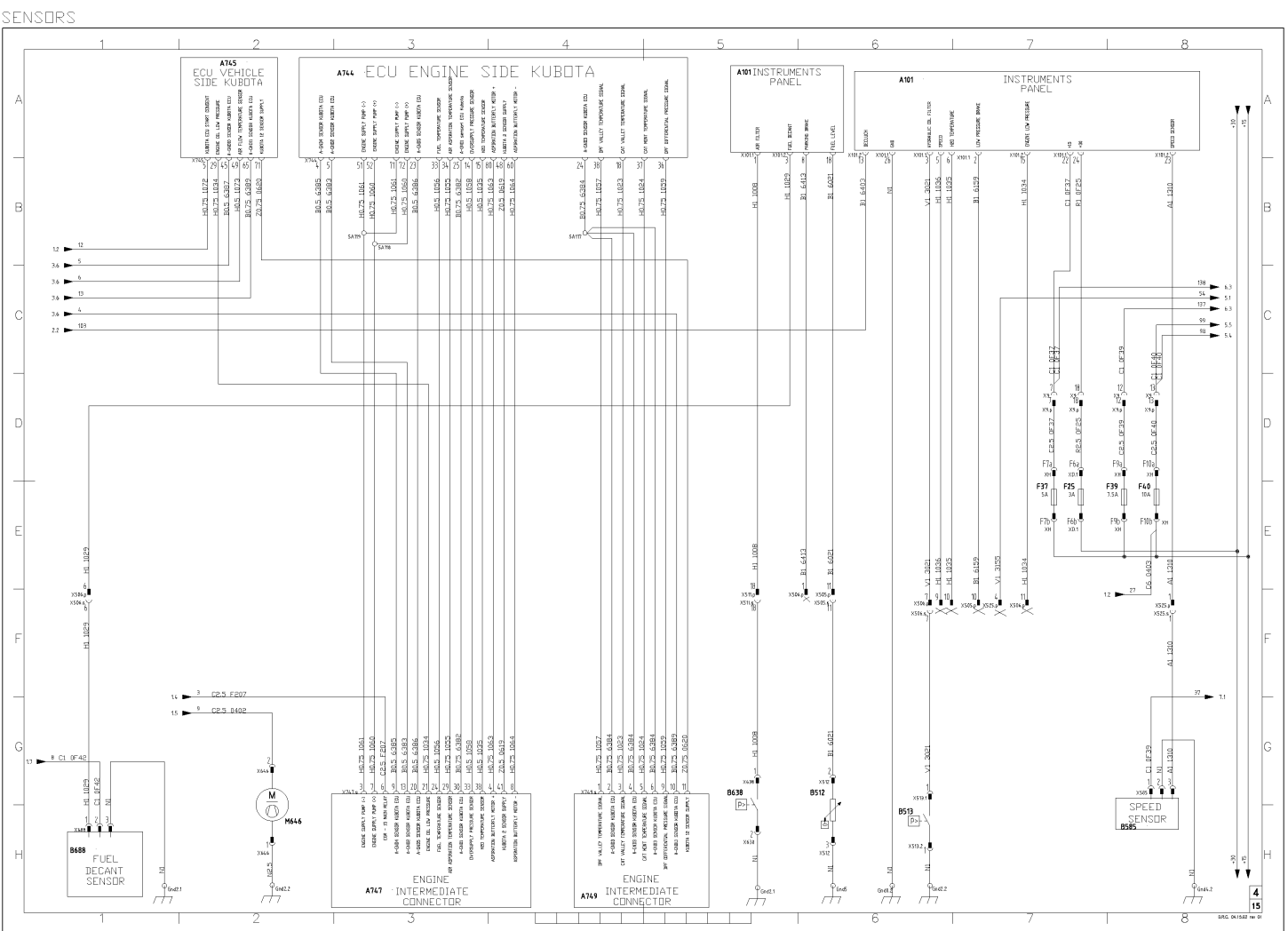

Illustration 11: Wiring diagram - APOLLO KE - 20150914_Page_04

HYDRAULIC MOVEMENTS

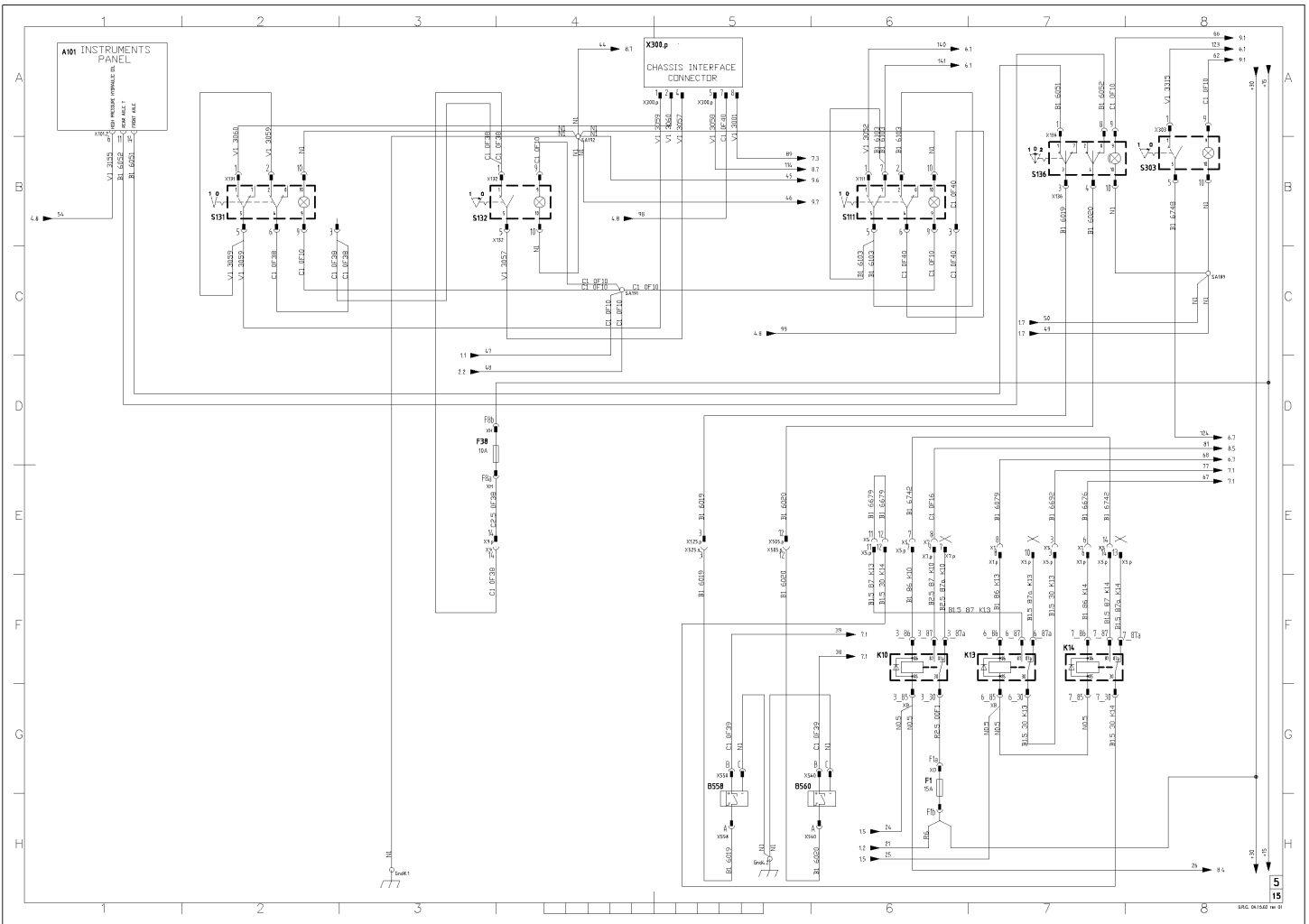

Illustration 12: Wiring diagram - APOLLO KE - 20150914_Page_05

HYDRAULIC MOVEMENTS

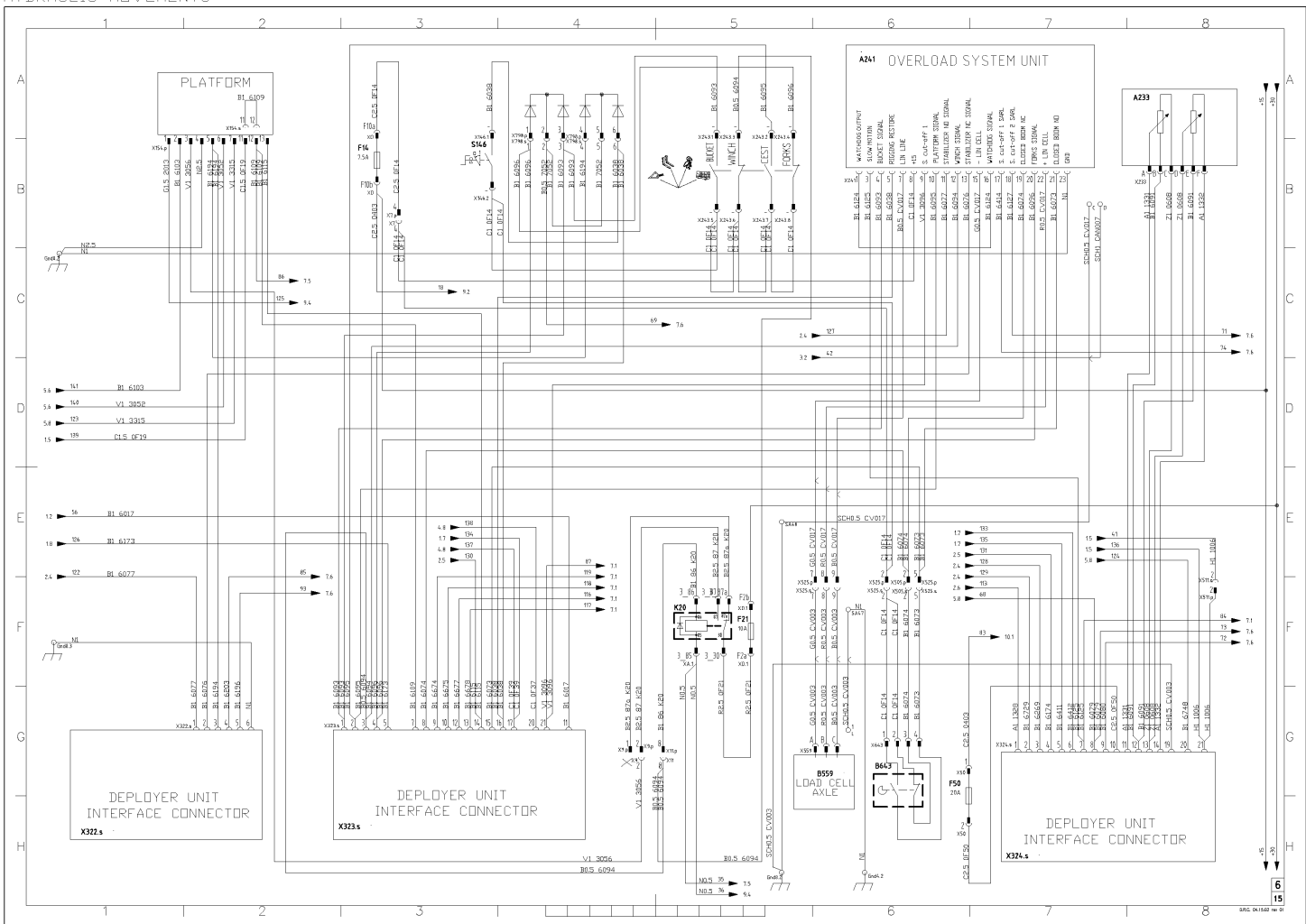

Illustration 13: Wiring diagram - APOLLO KE - 20150914_Page_06

HYDRAULIC MOVEMENTS

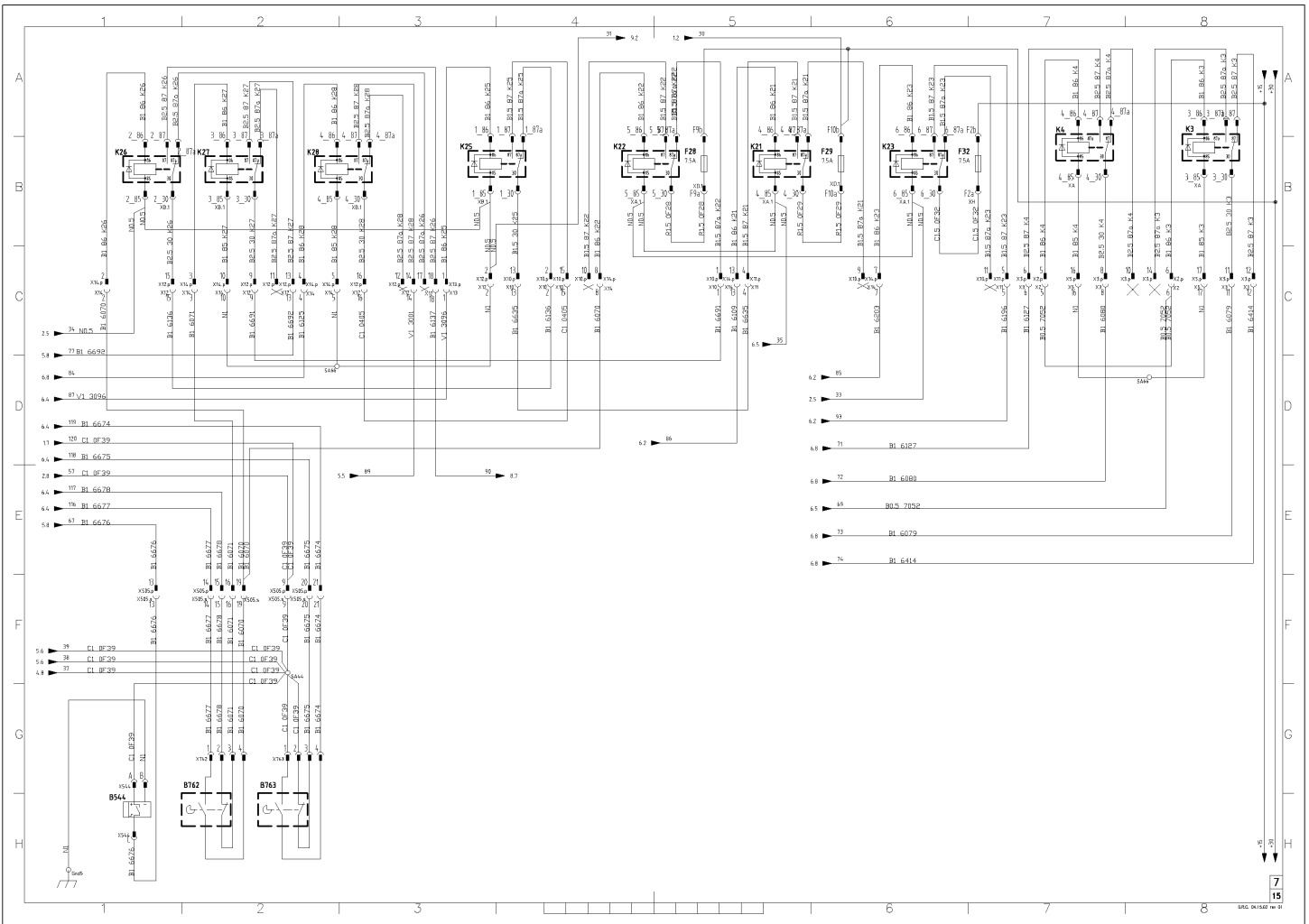

Illustration 14: Wiring diagram - APOLLO KE - 20150914_Page_07

LIGHTS AND CAB FUNCTIONS

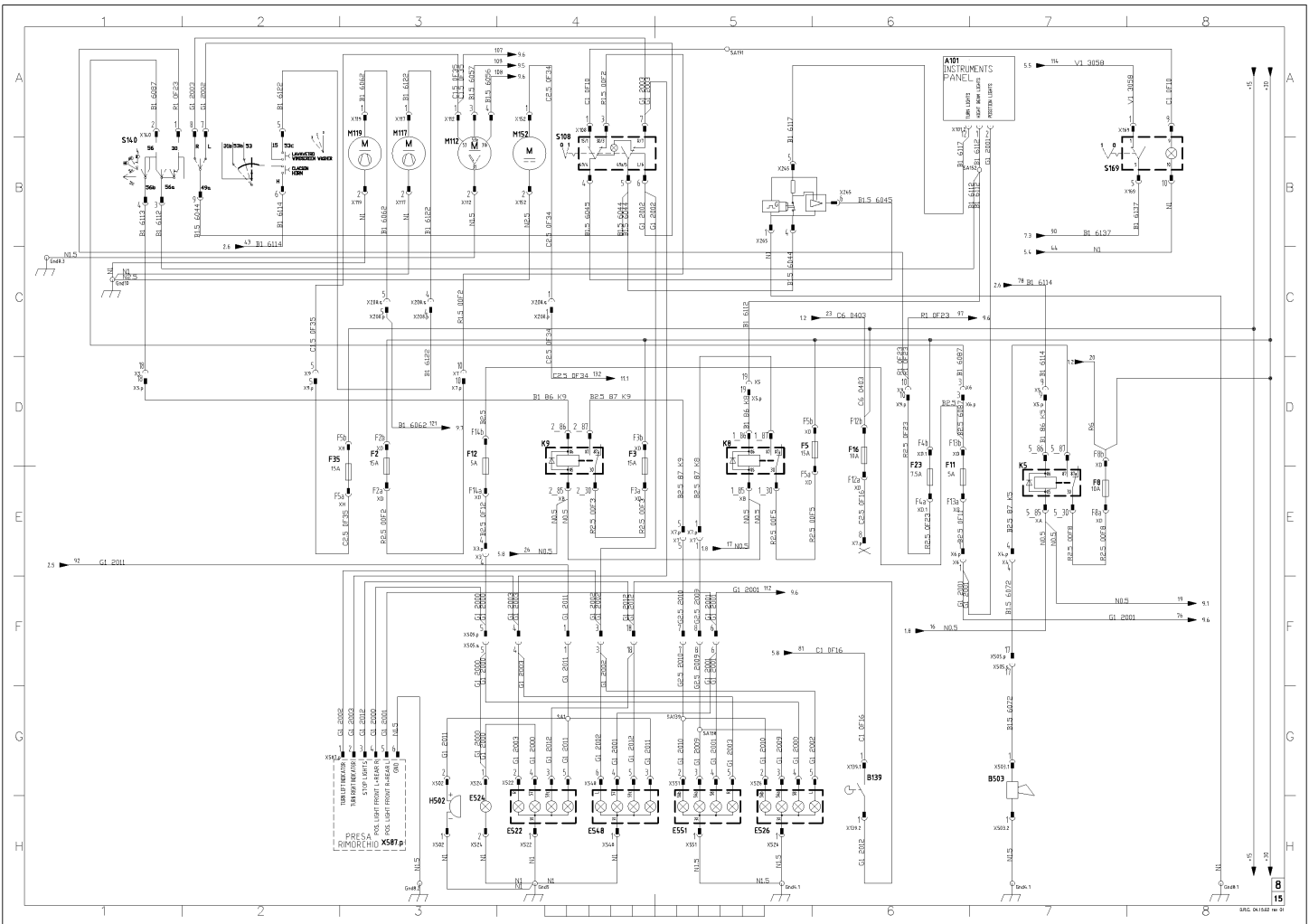

Illustration 15: Wiring diagram - APOLLO KE - 20150914_Page_08

LIGHTS AND CAB FUNCTIONS

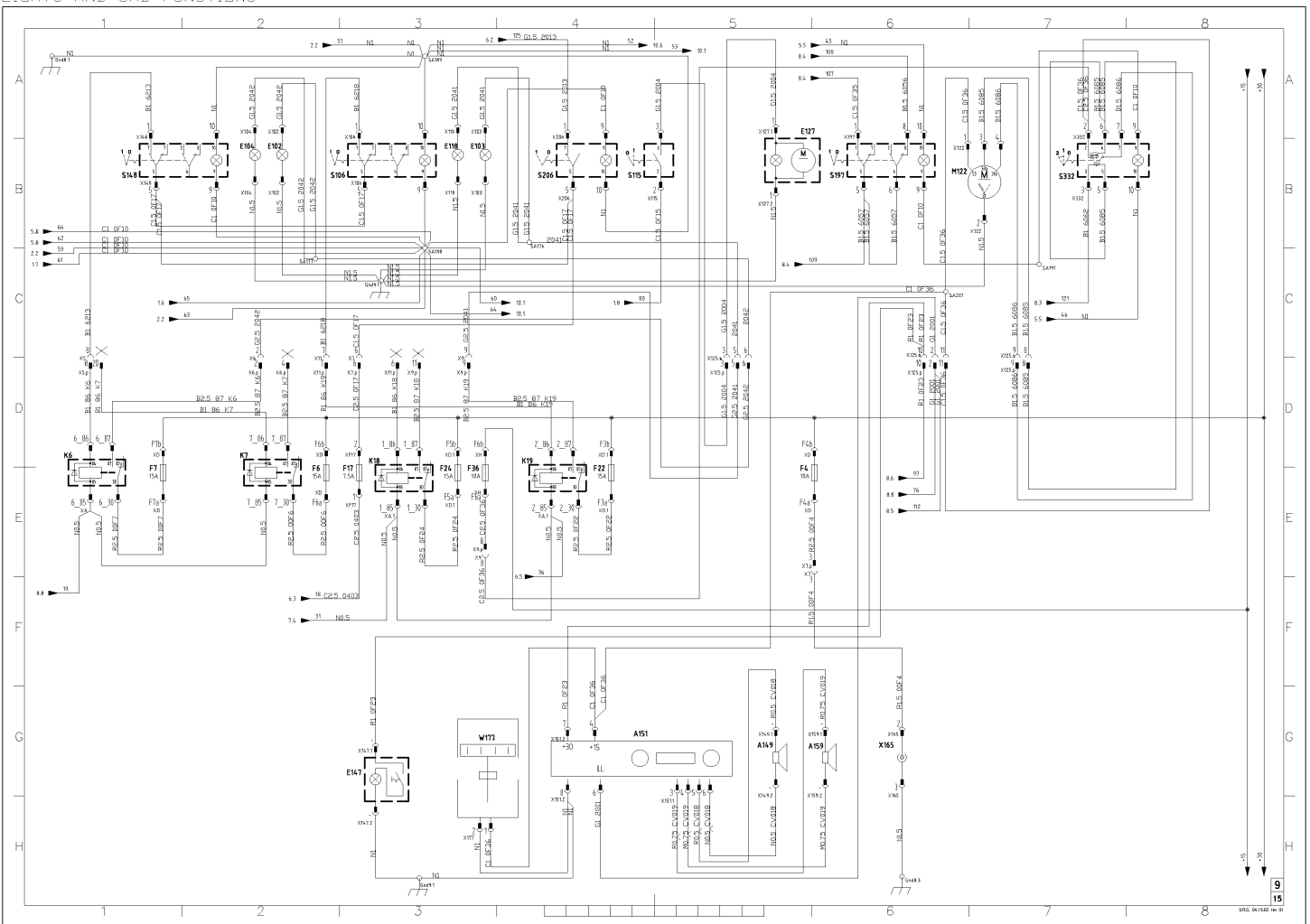

Illustration 16: Wiring diagram - APOLLO KE - 20150914_Page_09

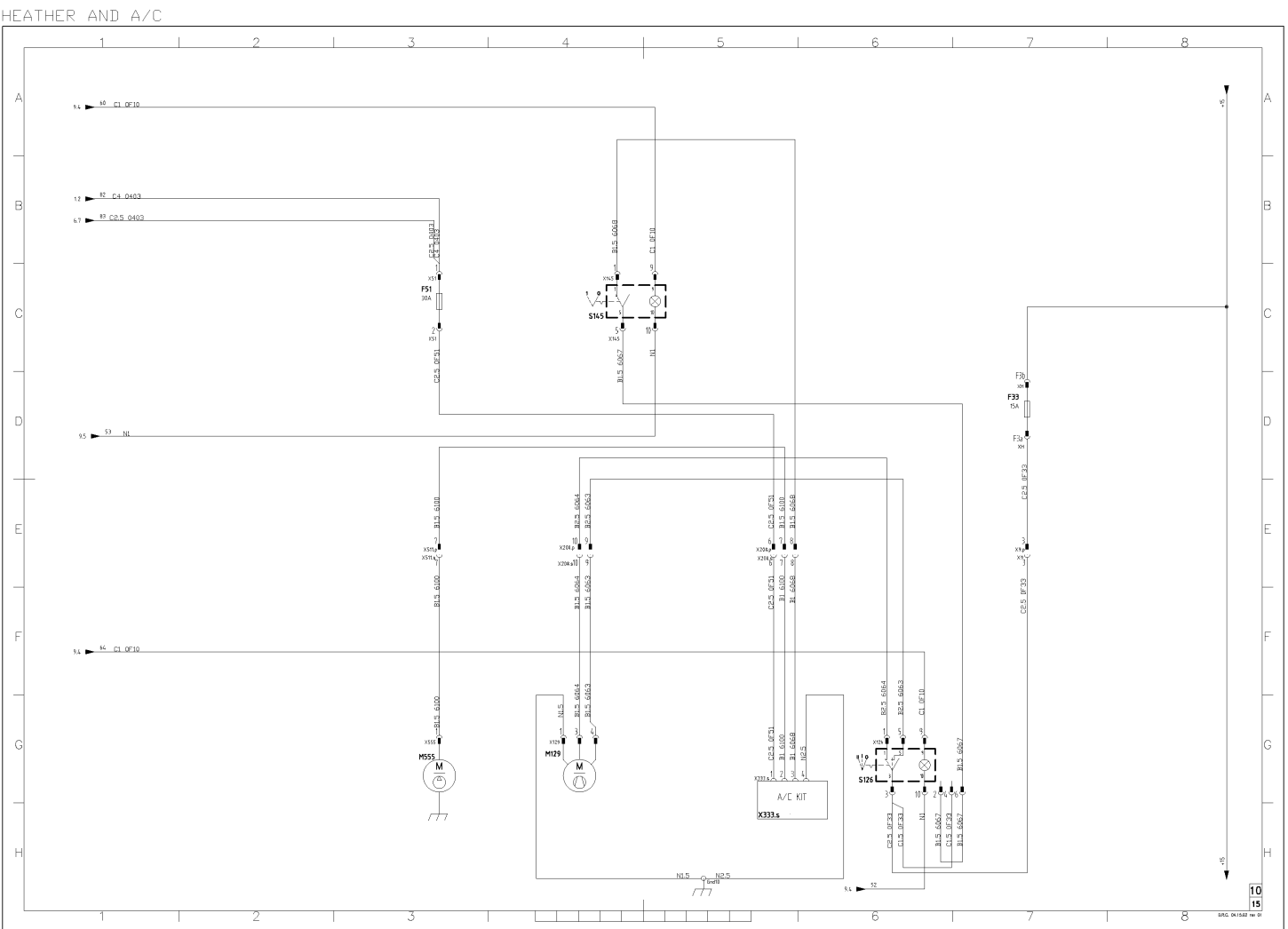

Illustration 17: Wiring diagram - APOLLO KE - 20150914_Page_10

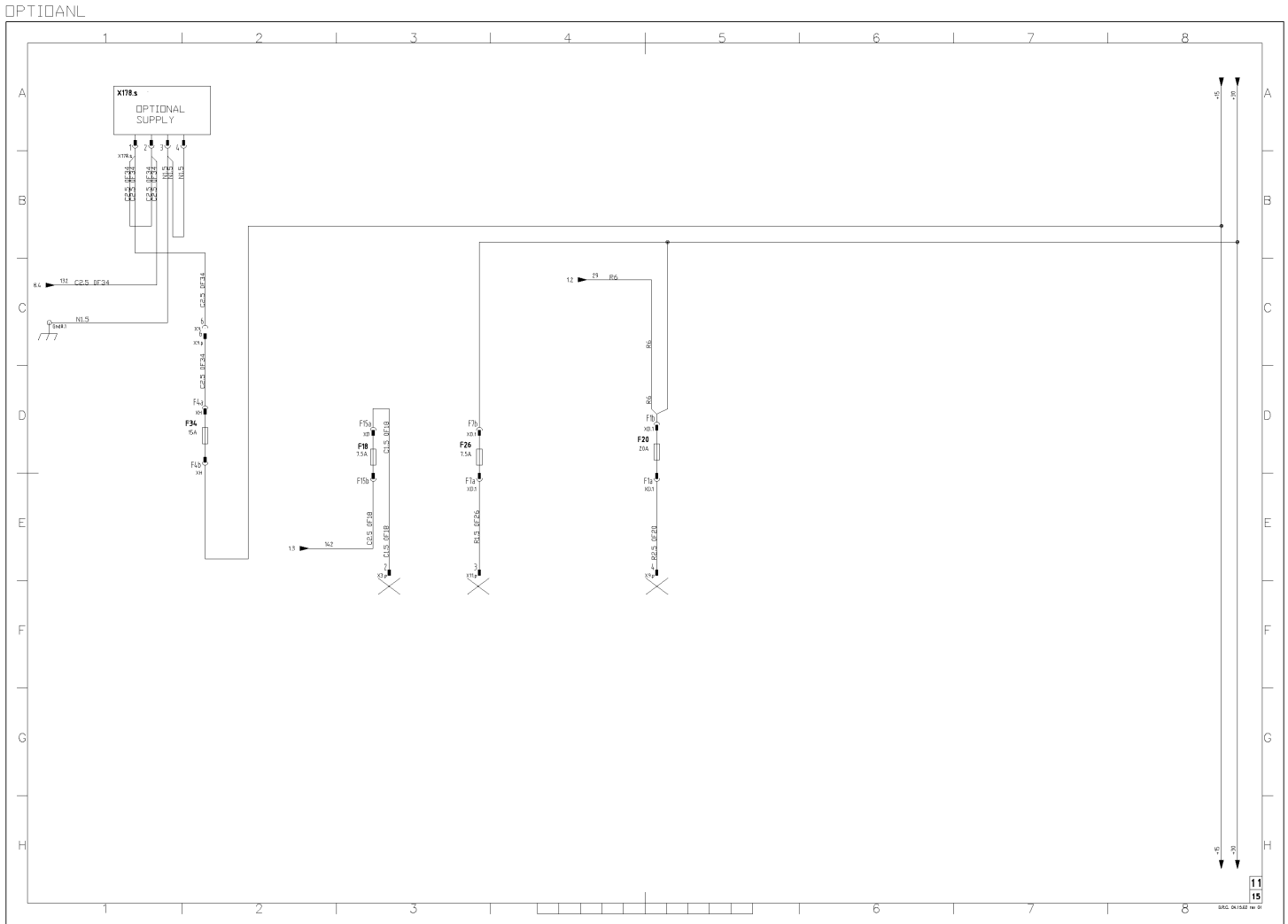

Illustration 18: Wiring diagram - APOLLO KE - 20150914_Page_11

20.3 Fuse box

The main circuit is protected by fuses placed in the general electronic board (fig. 150720-1).

To access the fuse box, remove the left plastic part aside the instrument panel by unscrewing the related screws (Fig 150720-2).

In case of electrical malfunction it is necessary to check the fuses as a first troubleshooting step.

WARNING! Before accessing the fuse box in the cab, set the vehicle in the maintenance position.

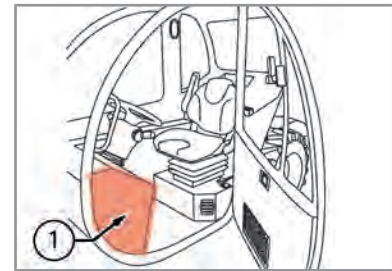

150720-2

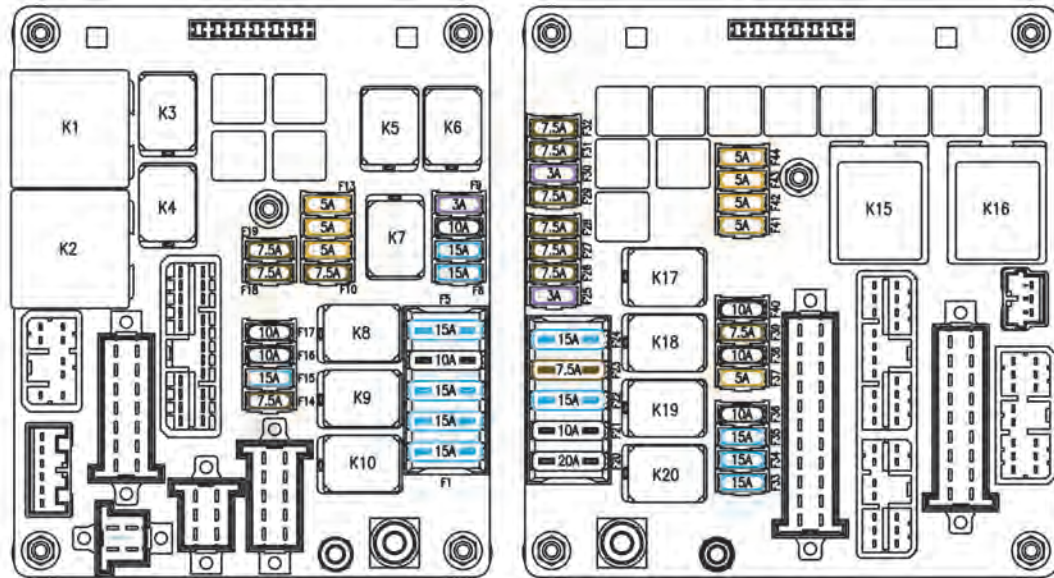
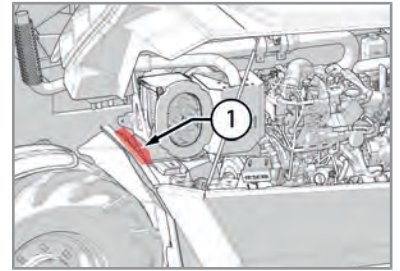

Illustration 19: 150720-1

20.4 Engine compartment fuses

The electrical circuits of the engine and attached components are protected by a fuse box placed in the engine compartment (fig. 150371-1). Remove the cover of the box to access the fuses. In case of electrical malfunction it is necessary to check the fuses as a first troubleshooting step.

WARNING! Before accessing the engine control unit set the vehicle in the maintenance position.



150371-1

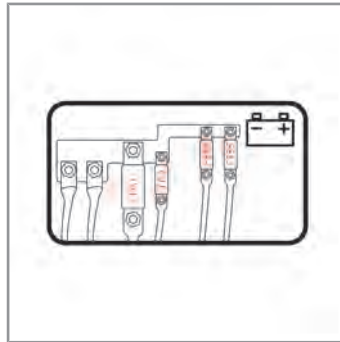

150371-2

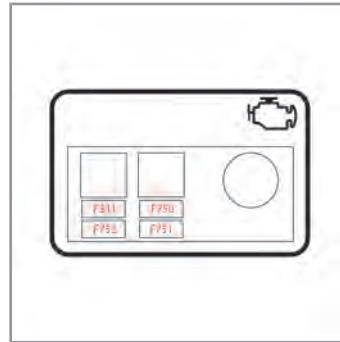

150371-3

21 Hydraulic diagram

21.1 Components legend

Legend	Description
1	Inching Pedal
2	Pump
3	Engine
4	Parking brake
5	Power steering
6	Front axle
7	Rear Axle
8	Steering gearbox valve
9	Priority valve
10	Service brake
11	Distributor
12	Lifting
13	Swiveling
14	Quick couplers
15	Extension
16	Flow Shearing Distributor
17	Additional quick couplings optional
18	Boom suspension optional
19	Closed center services optional
20	Tank

21.2 Hydraulic diagram

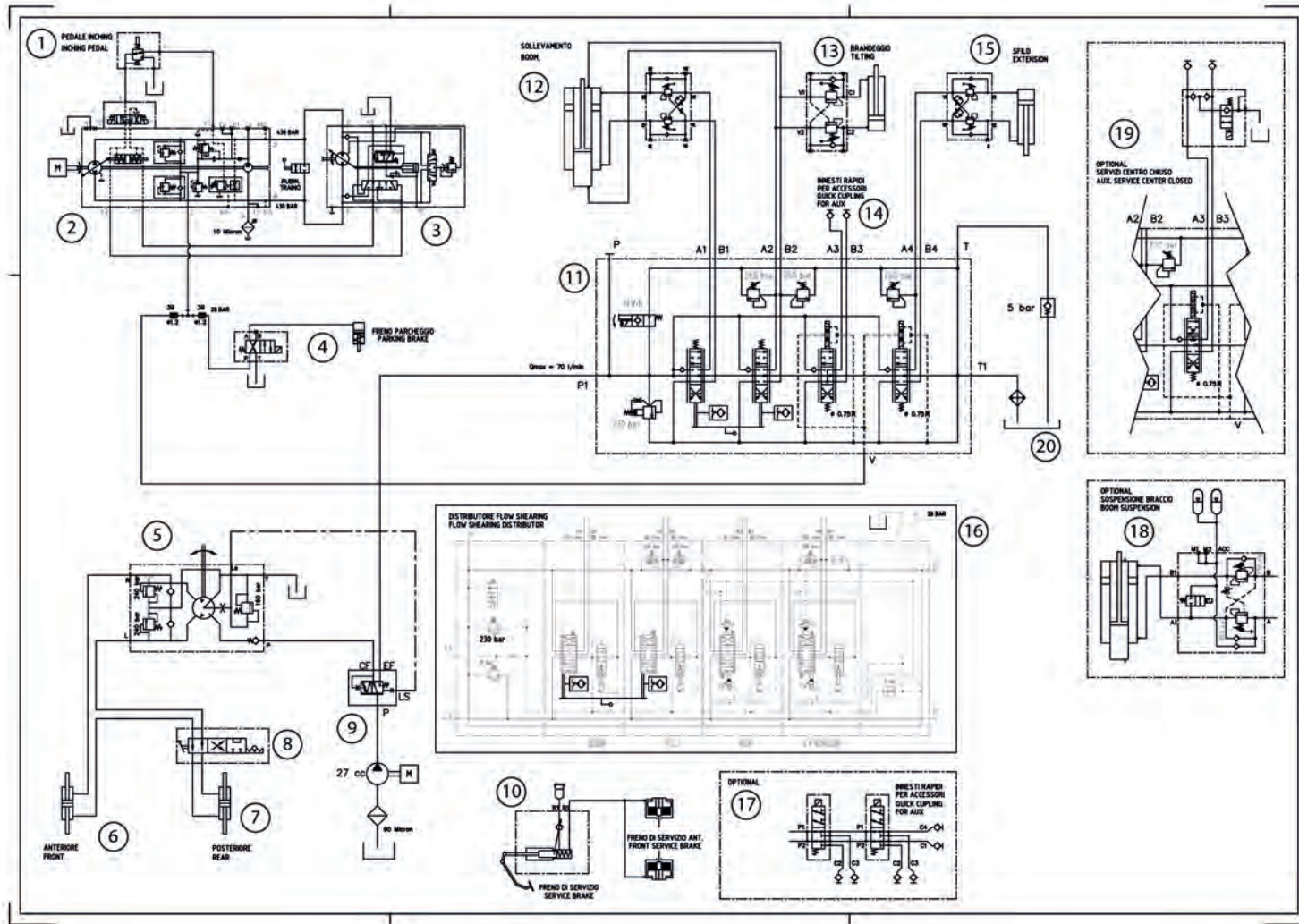

Illustration 20: Hydraulic diagram - Apollo 25.6 - JA15-08-A900 Model (1)

22 Technical data

22.1 Apollo 25.6

Info

<i>Vehicle Model</i>	Apollo 25.6
<i>Approval</i>	MFC3224
<i>Vehicle code</i>	XLC190
<i>Technical type</i>	190

Dimensions

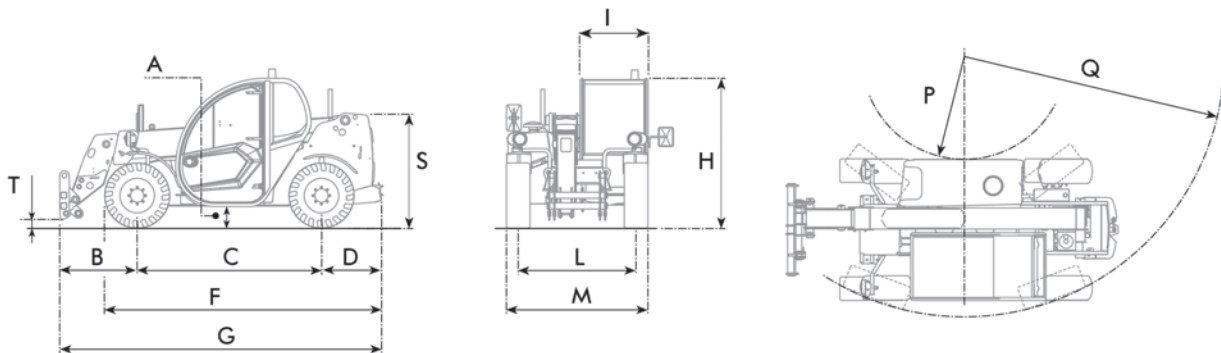

<i>Height from ground (A)</i>	270 mm (10.63 in)
<i>Distance between front axle and plate (B)</i>	985 mm (38.78 in)
<i>Wheelbase (C)</i>	2350 mm (92.52 in)
<i>Distance from rear axle to rear edge (D)</i>	765 mm (30.12 in)
<i>Chassis length (F)</i>	3535 mm (139.17 in)
<i>Maximum length without forks (G)</i>	4125 mm (162.4 in)
<i>Maximum height (H)</i>	1950 mm (76.77 in)
<i>Cab width (I)</i>	1850 mm (72.83 in)
<i>Axle track (L)</i>	1500 mm (59.06 in)
<i>Tire width (M)</i>	1850 mm (72.83 in)
<i>Internal curve radius (P)</i>	1460 mm (57.48 in)
<i>Wheels curve radius (Q)</i>	3555 mm (139.96 in)
<i>Rear side height (S)</i>	1433 mm (56.42 in)
<i>Plate distance from ground (T)</i>	200 mm (7.87 in)

Performance

<i>Maximum capacity- Maximum flow rate</i>	2500 kg (5511.56 lb)
<i>Maximum height capacity on wheels</i>	1700 kg (3747.86 lb)
<i>Maximum horizontal extension capacity on tires</i>	800 kg (1763.7 lb)
<i>Max lifting on tires</i>	5.78 m (18.96 ft)
<i>Max horizontal extension on tires</i>	3.25 m (10.66 ft)
<i>Plate rotation angle</i>	129°
<i>Maximum climb angle</i>	40%
<i>Pull-out force</i>	7600 daN (17085.48 lbf)
<i>Towing force</i>	4400 daN (9891.59 lbf)
<i>Lifting time</i>	7.8 s
<i>Lowering time</i>	4.1 s
<i>Exit time</i>	6.1 s
<i>Retraction time</i>	3.4 s
<i>Forward swivel time</i>	3.5 s
<i>Backward swivel time</i>	2.2 s

Weights

<i>Max weight</i>	5300 kg (11684.5 lb)
<i>Unladen weight</i>	5000 kg (11023.11 lb)
<i>Maximum allowed on front axle</i>	3000 kg (6613.87 lb)
<i>Maximum allowed on rear axle</i>	3000 kg (6613.87 lb)

Engine

<i>Brand/model</i>	Kubota V3307-DI-T-E3B
<i>Fuel</i>	Diesel
<i>Displacement</i>	3331 cm ³ (203.27 in ³)
<i>Operation</i>	4-stroke
<i>Cooling</i>	Liquid
<i>Nominal power</i>	54.6 kW (73.22 HP)
<i>Rpm per nominal power</i>	2600 rpm
<i>Cylinders</i>	4
<i>Injection</i>	Mechanical direct
<i>Consumption</i>	231 g/kWh (380 lb/Hp h)
<i>Rpm per consumption</i>	2600 rpm
<i>Intake</i>	Turbo compressor
<i>Air filter</i>	Replaceable cartridge for dry filter
<i>Overspeed protection on speed</i>	30 km/h (48.28 mph)
<i>Overspeed protection on rpm</i>	2700 rpm

Hydraulic system

<i>Hydraulic pump type</i>	Gear pump
<i>Hydraulic pump capacity</i>	80 L/min (21.13 gal/min)

<i>Maximum operating pressure</i>	23 MPa (3335.87 psi)
<i>Distributor control</i>	4in1
<i>Optional distributor control</i>	4in1 with FNR
<i>Rear hydraulic sockets</i>	1

Transmission

<i>Transmission type</i>	Hydrostatic with variable flow pump
<i>Hydraulic motor</i>	Hydrostatic with automatic adjustment
<i>Reversal</i>	Electrohydraulic
<i>Inching</i>	Hydraulic

Axles

<i>Driving</i>	Front and rear
<i>Service braking</i>	Oil bath on front axle
<i>Parking braking</i>	Negative actuation
<i>Swinging</i>	Rear
<i>Type of steering</i>	2WS - 4WS - CRAB

Acoustic pressure

<i>Reference standard for stopped and running vehicle</i>	Directive - 2009/63 / EC
<i>Value with stopped vehicle</i>	82.3 dB(A)
<i>Value with running vehicle</i>	84.7 dB(A)
<i>Reference standard perceived by the operator</i>	UNI EN 12053:2008
<i>Value perceived by the operator with closed cab</i>	75.0 dB(A)

Acoustic power

<i>Reference standard</i>	Directive - 2000/14 / EC
<i>Measured value (L_{wam})</i>	103.0 dB(A)
<i>Guaranteed value (L_{wa})</i>	104.0 dB(A)

Vibration

<i>Reference standard for seat vibrations</i>	UNI EN 13059
<i>Value for seat vibrations</i>	1.20 m/s ² (3.94 ft/s ²)
<i>Uncertainty for seat vibrations value</i>	0.18 m/s ² (0.59 ft/s ²)
<i>Reference standard for steering wheel vibrations</i>	EN 1032
<i>Value for steering wheel vibrations</i>	1.84 m/s ² (6.04 ft/s ²)
<i>Uncertainty for steering wheel vibrations value</i>	0.36 m/s ² (1.18 ft/s ²)

Load to ground

<i>Load per wheel</i>	4000 daN (8992.36 lbf)
-----------------------	------------------------

Filling

<i>Engine oil quantity</i>	11.20 L (2.96 gal)
----------------------------	--------------------

Engine oil specifications	- API CJ-4 - (Above 25°C) SAE30 / SAE10W-30 / SAE15W-40 - (-10°C up to 25°C) SAE10W-30 / SAE15W-40 - (Below -10°C) SAE10W-30
Front axle differential oil quantity	4.20 L (1.11 gal)
Front axle reduction gear oil quantity	0.75 L (0.2 gal)
Rear axle differential oil quantity	4.00 L (1.06 gal)
Rear axle reduction gear oil quantity	0.90 L (0.24 gal)
Axle oil specifications	SAE85W90, API GL4, MIL L-2105
Transmission gearbox oil quantity	4.00 L (1.06 gal)
Transmission gearbox oil specifications	SAE 85W90LS, API GL5
Braking circuit oil quantity	0.80 L (0.21 gal)
Braking circuit oil specifications	DEXRON II
Coolant quantity	12.00 L (3.17 gal)
Coolant specifications	Red Antifreeze
Grease quantity	4.00 kg (8.82 lb)
Grease specifications	NLGI - 1
Hydraulic oil quantity	70.0 L (18.49 gal)
Hydraulic oil type	DIECI Hydro Telehandler Fluid ISO46
Air conditioning quantity	1.10 kg (2.43 lb)
Air conditioning specifications	R134A
Fuel quantity	80.0 L (21.13 gal)

Diagrams

Diagrams code	Vehicle code	Vehicle model	Production equipment code	Price list equipment code	Unit of measure	Operating Mode
AXB1377	MFC3224	Apollo 25.6	BCV8071	TCV0014	Metric	Wheels - 0°
AXB1377-550	MFC3224	Apollo 25.6	BCV8071	TCV0014	Imperial	Wheels - 0°

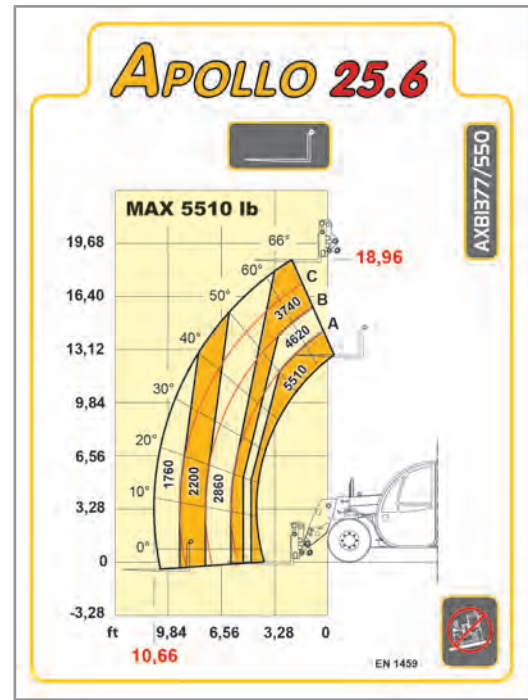
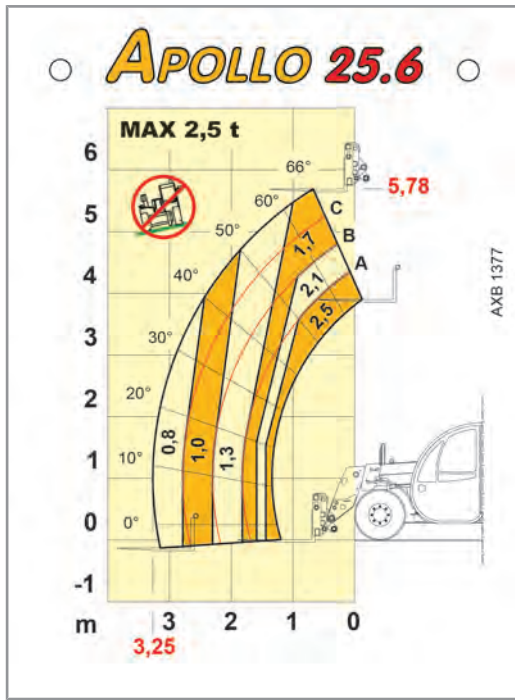

Dieci equipment which can be installed

Vehicle code	Vehicle model	Production equipment code	Price list equipment code	Unit of measure
MFC3224	Apollo 25.6	BCV8071	TCV0014	Fixed counterplate with floating forks 120 x 45 L=1,200 mm
MFC3224	Apollo 25.6	BCV8070	TCV0015	Translating counterplate internal L=1100 with floating forks 120x45 L=1200 mm
MFC3224	Apollo 25.6	BCV8077	TCV0016	Translating counterplate internal L=1400 with floating forks 120x45 L=1200 mm
MFC3224	Apollo 25.6	BUD1190	TFR0016	Pair of fork extensions L = 1900 mm for forks mm 120 x 45
MFC3224	Apollo 25.6	BUD1126/OG	TFR0019	Fork counterplate guard
MFC3224	Apollo 25.6	BUB2629	TBN0067	4 in 1 bucket L= 1730 mm
MFC3224	Apollo 25.6	BUB2480	TBN0068	Excavating bucket with teeth, m ³ 0.48 full SAE, (width 1.78 m) with teeth protection cover
MFC3224	Apollo 25.6	BUB2480/S	TBN0069	Excavating bucket with teeth, m ³ 0.48 full SAE, (width 1.78 m) with blade protector.
MFC3224	Apollo 25.6	BUB2481	TBN0070	Excavating bucket without teeth, m ³ 0.48 full SAE, (width 1.78 m) with blade protection cover
MFC3224	Apollo 25.6	BUB2481/S	TBN0071	Excavating bucket without teeth, m ³ 0.48 full SAE, (width 1.78 m) con blade protector
MFC3224	Apollo 25.6	BUB2489	TBN0074	Bucket for light material (spec. weight max 0.8 t/m ³) from 0.90 m ³ full SAE (width 1.78 m)
MFC3224	Apollo 25.6	BUB2489/S	TBN0075	Bucket for light material (spec. weight max 0.8 t/m ³) from 0.90 m ³ full SAE (width 1.78 m) con blade protector
MFC3224	Apollo 25.6	BUB2496	TBN0076	Bucket for light material (spec. weight max 0.8 t/m ³) from 0.9 m ³ full SAE (width 1.78 m) with holder
MFC3224	Apollo 25.6	BUD3058	TBN0077	Mixing bucket l. 350
MFC3224	Apollo 25.6	BUD1178	TGN0038	Tilt dozer blade - Total width 2400 mm Angled 2250 mm

Vehicle code	Vehicle model	Production equipment code	Price list equipment code	Unit of measure
MFC3224	Apollo 25.6	BUD1176	TGN0039	Angledozer blade - Total width 2100 mm Angled 1820 mm
MFC3224	Apollo 25.6	BUD1180	TGN0040	Floating snow plow blade Total width 2100 mm Angled 1860 mm
MFC3224	Apollo 25.6	BUD4073	TGN0041	Angled sweeper L=2100 mm
MFC3224	Apollo 25.6	BUD4063	TGN0042	Sweeper with collection bucket L=2100 mm
MFC3224	Apollo 25.6	BUD6466	TCS0044	Front passenger basket cm 70 x 140. Capacity 200 kg incl. 2 people.
MFC3224	Apollo 25.6	BUD6280	TCS0045	Material basket 160 x 100 x 130 cm with side door. Capacity 500 kg
MFC3224	Apollo 25.6	BUD4518	TSL0039	Jib (crane extension) L = 1.3 m with winch (Capacity 1.8 t)
MFC3224	Apollo 25.6	BUD4519	TSL0040	Jib (crane extension) L = 1.3 m with hook (Capacity 1.8 t)
MFC3224	Apollo 25.6	BUD4520	TSL0041	Jib (crane extension) L = 2.5 m with winch (Capacity 1.1 t)
MFC3224	Apollo 25.6	BUD4521	TSL0042	Jib (crane extension) L = 2.5 m with hook (Capacity 1.1 t)
MFC3224	Apollo 25.6	BUD4497	TSL0043	Jib L = 1.00 m with hook (2.0 t capacity)
MFC3224	Apollo 25.6	BUB2486	TSL0044	Hook for fork carriage with the same capacity as the vehicle.

22.1.1 Equipment

	Production code	Description
TCV0014	BCV8071	Fixed counterplate with floating forks 120 x 45 L=1,200 mm
TCV0015	BCV8070	Translating counterplate internal L=1100 with floating forks 120x45 L=1200 mm
TCV0016	BCV8077	Translating counterplate internal L=1400 with floating forks 120x45 L=1200 mm
TFR0016	BUD1190	Pair of fork extensions L = 1900 mm for forks mm 120 x 45
TFR0019	BUD1126/0G	Fork counterplate guard
TBN0067	BUB2629	4 in 1 bucket L= 1730 mm
TBN0068	BUB2480	Excavating bucket with teeth, m ³ 0.48 SAE heaped, (width 1.78 m) with teeth protection cover. (The bucket with blade protector is recommended)[Equipment approved for road circulation in Italy]
TBN0069	BUB2480/S	Excavating bucket with teeth, m ³ 0.48 SAE heaped, (width 1.78 m) with protection.
TBN0070	BUB2481	Digging bucket without teeth, capacity 0.48 m ³ full SAE (width 1.78 m) with blade protection cover. (The bucket with blade protector is recommended)[Equipment approved for road circulation in Italy]
TBN0071	BUB2481/S	Excavating bucket without teeth, m ³ 0.48 SAE heaped, (width 1.78 m) with protection
TBN0074	BUB2489	Bucket for light materials (max spec. weight 0.8 t/ m ³) m ³ 0.90 SAE heaped (width 1.78 m) (The bucket with anti-wear blade protector is recommended)
TBN0075	BUB2489/S	Bucket for light materials (max spec. weight 0.8 t/ m ³) m ³ 0.90 SAE heaped (width 1.78 m) with blade protector
TBN0076	BUB2496	Bucket for light materials (max spec. weight 0.8 t/ m ³) m ³ 0.90 SAE ridge (width 1.78 m) with holder
TBN0077	BUD3058	Mixing bucket 350 l.
TGN0038	BUD1178	Tilt dozer blade - Total width 2400 mm, Angled 2250 mm
TGN0039	BUD1176	Angledozer blade - Total width 2100 mm, angled 1820 mm
TGN0040	BUD1180	Floating snow plow blade - Total width 2100 mm, angled 1820 mm
TGN0041	BUD4073	Angled sweeper L=2100 mm
TGN0042	BUD4082	Sweeper with collection bucket L=2100 mm
TCS0044	BUD6466	Aluminum front man basket cm 70 x 140. Capacity 200 kg incl. 2 people.[AID2247 pre-arrangement compulsory]
TCS0045	BUD6280	Material basket 160 x 100 x 130 cm with side door. Capacity 500 kg
TSL0039	BUD4518	Jib (crane extension) L = 1.3 m with winch (Capacity 1.8 t) [AID2247 or AID2275 pre-arrangement compulsory. Incompatible with closed center services distributor]
TSL0040	BUD4519	Jib (crane extension) L = 1.3 m with hook (Capacity 1.8 t) [AID2247 (where present) or AID2275 pre-arrangement compulsory]
TSL0041	BUD4520	Jib (crane extension) L = 2.5 m with winch (Capacity 1.1 t) [AID2247 or AID2275 pre-arrangement compulsory. Incompatible with closed center services distributor]

	Production code	Description
TSL0042	BUD4521	Jib (crane extension) L = 2.5 m with hook (Capacity 1.1 t) [AID2247 (where present) or AID2275 pre-arrangement compulsory]
TSL0043	BUD4383, BUD4497	Jib L = 1.00 m with hook (2.0 t capacity)[AID2247 (where present) or AID2275 pre-arrangement compulsory]
TSL0044	BUB2486	Hook for fork carriage with the same capacity as the vehicle.

22.2 Environmental conditions

Although the vehicle can be used in several different situations, however, it is necessary to observe, as a precautionary measure, compliance with minimum standards of operation as specified below:

Parameter	Allowed values
Operating temperatures	from -20°C to +40 °C (from -4 °F to 104 °F)
Average daily temperature	< +40 °C (< 104 °F)
Storage temperature	from -25°C to +50 °C (from -13 °F to 122 °F)
Humidity	from 20 % to 95 %
Altitude	< 2500 m (< 8200 ft)

Table 1: Environmental conditions table

22.3 Electromagnetic Interference

In the case of additional equipment installed by the customer, the user must verify if the installation causes interference of any kind with the tools of the vehicle; if so, the user must correct such interferences.

It is essential to pay particular attention to mobile devices such as radio communications (telephones) that must be installed by trained service technicians must use externally mounted antennas.

In general, it should be kept in mind that any additional electrical equipment installed must comply with the EMC Directive 2004/108/EC and must bear the "CE" mark.

22.4 Radiations

The machine, in conditions of normal use, does not produce any type of radiation, ionizing and non ionizing, that can cause problems to the operator.

22.5 Standard hydraulic oil

Specifications: DIECI Hydro Telehandler Fluid ISO46

ISO 6743-4 HV, Afnor NFE 48-602, ISO 11158, DIN 51524 Part 3 HVL, Afnor NFE 48-603 HV, ASTM D6158, Denison HF-0 / HF-1 / HF-2, Eaton Vickers I-286-S / M-2950-S, Cincinnati Machine P-68 / P-69 / P-70, Afnor NFE 48-690(dry), Afnor NFE 48-691(wet), U.S. Steel 126 / 127 / 136, JCMAS HK, Bosch variable vane pumps, Rexroth RE 90220, Sauer Danfoss 520L0463, General Motors (LS-2) LH-03-1 / LH-04-1 / LH-06-1, SEB 181222.

Properties	Analysis method	Unit of measure	Value
Density at 15°C	ASTM D1298	kg/l	0.88
Kinematic viscosity at 40°C	ASTM D445	cSt	46.6
Kinematic viscosity at 100°C	ASTM D445	cSt	8.6

Properties	Analysis method	Unit of measure	Value
Viscosity Index	ASTM D2270	-	165
Kinematic viscosity at 40°C after Sonic Shear	ASTM D445	cSt	41.6
Viscosity Index after Sonic Shear	ASTM D2270	-	144
FZG Failure Load Stage	ASTM D5182	Stage	12
Flash Point (C.O.C.)	ASTM D92	°C	210
Pour point	ASTM D97	°C	-35
Temperature for Brookfield viscosity of 750cP	ASTM D2983	°C	-9

22.6 Hydraulic oil for cold climates



NOTICE

Hydraulic oil for cold climates is an optional.

Consult your dealer in case of doubts or information on your vehicle.

Specifications: DIECI Hydro Telehandler Fluid ISO32

ISO 6743-4 HV, Afnor NFE 48-602, ISO 11158, DIN 51524 Part 3 HVLP, Afnor NFE 48-603 HV, ASTM D6158, Denison HF-0 / HF-1 / HF-2, Eaton Vickers I-286-S / M-2950-S, Cincinnati Machine P-68 / P-69 / P-70, Afnor NFE 48-690(dry), Afnor NFE 48-691(wet), U.S. Steel 126 / 127 / 136, JCMAS HK, Bosch variable vane pumps, Rexroth RE 90220, Sauer Danfoss 520L0463, General Motors (LS-2) LH-03-1 / LH-04-1 / LH-06-1, SEB 181222

Properties	Analysis method	Unit of measure	Value
Color	-	-	Green-Blue
Density at 15°C	ASTM D1298	kg/l	0.878
Kinematic viscosity at 40°C	ASTM D445	cSt	32.4
Kinematic viscosity at 100°C	ASTM D445	cSt	6.6
Viscosity Index	ASTM D2270	-	165
Flash Point (C.O.C.)	ASTM D92	°C	205
Pour point	ASTM D97	°C	-37

22.7 Fork technical data

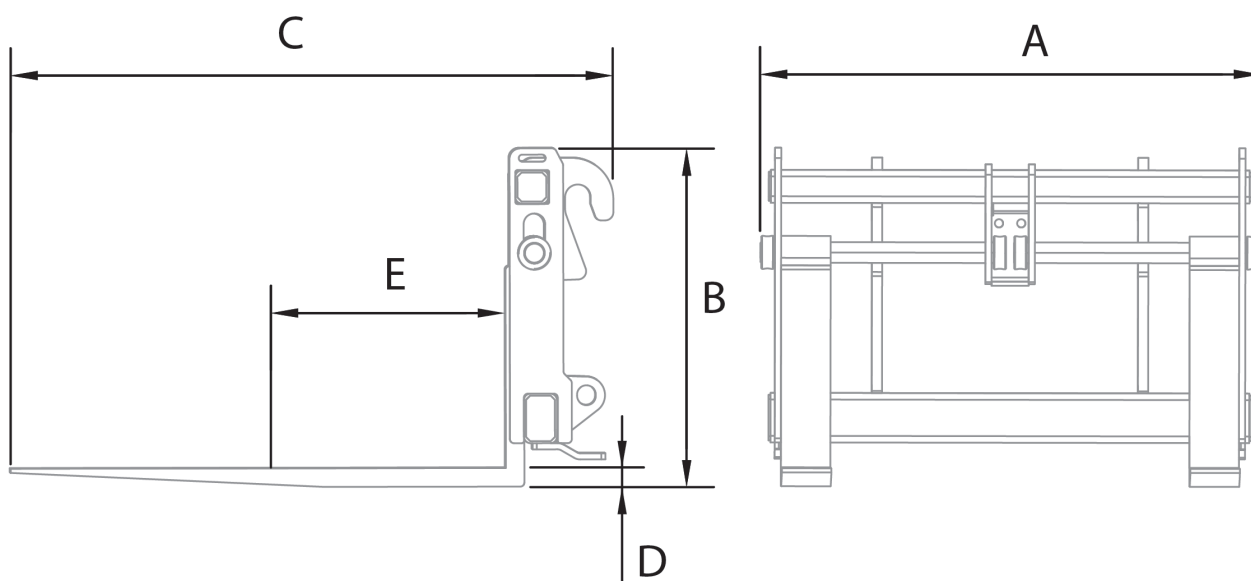

Equipment code	Capacity	A	B	C	D	E	Weight
BCV8071	2500 kg (5510 lb)	1210 mm (47.63 in)	715 mm (28.14 in)	1468 mm (57.79 in)	120x45 mm (4.72x1.77 in)	500 mm (19.68 in)	250 kg (551 lb)

22.8 Fork shifter technical data

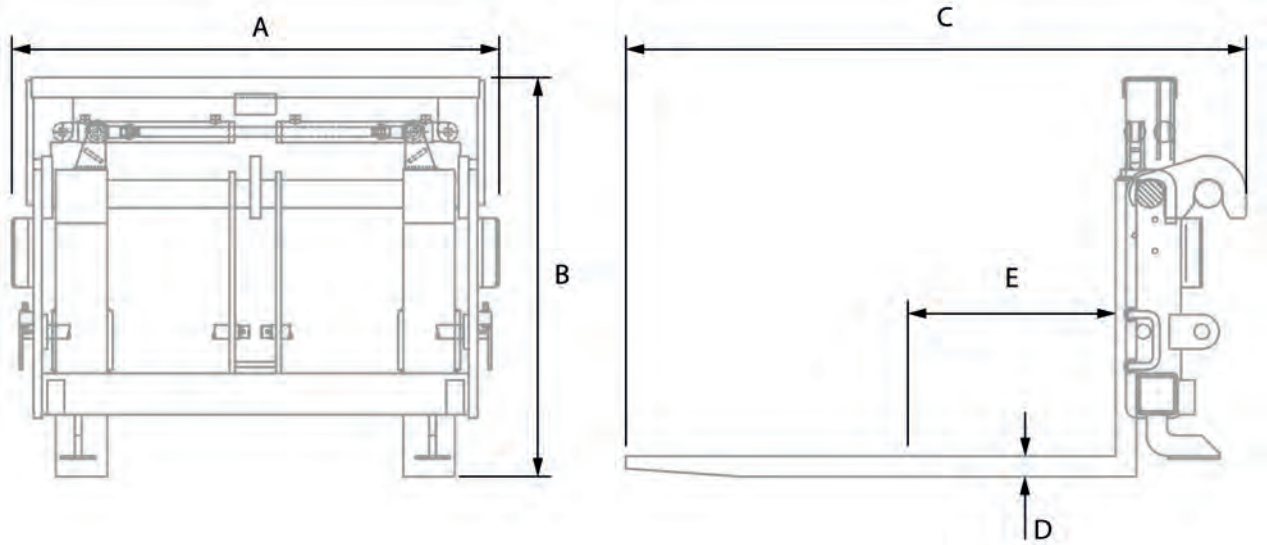

Code	A	B	C	D	E	Capacity	Weight
BCV8070	1170 mm (46.06 in)	755 mm (29.72 in)	1540 mm (60.63 in)	120x45 mm (4.72x1.77 in)	500 mm (19.69 in)	2500 kg (5511.56 lb)	320 kg (705.48 lb)
BCV8077	1470 mm (57.87 in)	755 mm (29.72 in)	1540 mm (60.63 in)	120x45 mm (4.72x1.77 in)	500 mm (19.69 in)	2500 kg (5511.56 lb)	350 kg (771.62 lb)

22.9 Buckets technical data

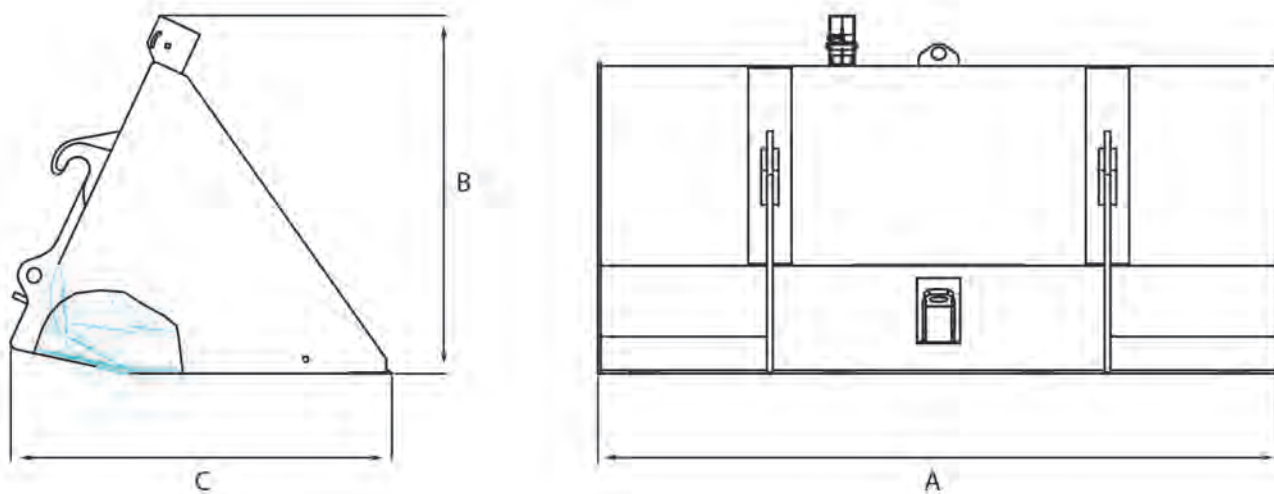

Equipment code	Capacity	Type of use	A	B	C	Weight
BUB2480	0.48 m ³ (16,95 ft ³)	For digging	1820 mm (71.65 in)	884 mm (34.8 in)	800 mm (31.5 in)	300 kg (661.39 lb)
BUB2481	0.48 m ³ (16,95 ft ³)	For digging	1820 mm (71.65 in)	884 mm (34.8 in)	845 mm (33.27 in)	285 kg (628.32 lb)
BUB2489	0.9 m ³ (31,78 ft ³)	Light materials	1800 mm (70.87 in)	1015 mm (39.96 in)	1098 mm (43.23 in)	270 kg (595.25 lb)

22.10 Tires data

Type	Installation	Tire dimensions	Characteristics	Brand	bar	MPa	psi	Rim size	Drawing
190	Standard	12-16.5	12PR	BKT	5.50	0.55	79	9.78 x 16.5	TL NHS
190	Alternative	12-16.5	12PR	FOX TYRE	4.50	0.45	65	9.75 x 16.5	F801, 802, 805
190	Alternative	12-16.5	12PR	CODEX	4.50	0.45	65	9.75 x 16.5	SK01 RG
190	Alternative	12-16.5	12PR	ETO	4.75	0.48	68	9.75 x 16.5	ET-201
190	Alternative	12-16.5	12PR	EASTONE	4.75	0.48	68	9.75 x 16.5	TL NHS
190	Alternative	12-16.5	12PR	SOLIDEAL	5.60	0.56	81	9.75 x 16.5	SKS XTRA
190	Alternative	10-16.5	10PR	ETO	4.25	0.43	61	8.25 x 16.5	ET-201
190	Alternative	12.0/75-18	12PR	MITAS	4.00	0.40	58	11 x 18	TR-11 TL
190	Alternative	12.0/75-18	12PR	MITAS	4.00	0.40	58	11 x 18	TR-03 TL

23 Control and maintenance logs

The Control Log and Maintenance Log are to be considered as integral parts of the machine and equipment. These logs must therefore accompany the machine and equipment for their life, to final disposal.

23.1 Type of logs

23.1.1 Control log

On the Control Log are recorded the main checks on the safety devices of the equipment, recommended by **Dieci S.r.l.**, with the related deadlines.

These checks ensure the proper operation of the safety devices.



NOTICE

The checks specified in the Control Log are in addition to the routine maintenance described in the Maintenance Log.

23.1.2 Maintenance Log

On the Maintenance Log are recorded all scheduled maintenance with timelines, referred to the use in normal, and not heavy, conditions. Such maintenance interventions allow to keep the machine or the equipment in the best efficiency conditions.

The scheduled maintenance intervals frequency must be reduced even to daily, if necessary, in particularly heavy working conditions (humidity, mud, sand, high dust level, etc ...).



NOTICE

Consult the **DIECI** service center to establish appropriate timelines when working in particularly heavy environments.

23.2 Instructions for compiling the logs

23.2.1 Warnings on the control log

- The log must be prepared in accordance with the requirements imposed by the Essential Safety Requirement 4.4.2.b Annex I of the Machinery Directive 2006/42/EC, in order to preserve evidence of the proper conduct of all the inspection and maintenance activities concerning the machine safety.
- In the log, in addition to all the activities relating to the life, use and maintenance of safety systems of the machine (replacement of parts, overhauls, breakdowns, etc.) it is necessary to record all the checks required by the regulations in force in the country where the machine is used.
- It is also necessary that the name of the verifier technician and date of intervention are clearly identifiable.
- It is recommended to prepare, update and preserved with care, for the entire life of the machine or equipment, the control log.



NOTICE

Here following there are some pages to allow compiling such logs.

Consult the Dieci s.r.l. service center to obtain more information regarding the availability of control and maintenance logs.

23.2.2 Warnings on the maintenance log

- The maintenance log shall prevail for warranty claims. All activities relating to the life, use and maintenance of the machine must be registered in the log.

23.2.3 Logs compiling





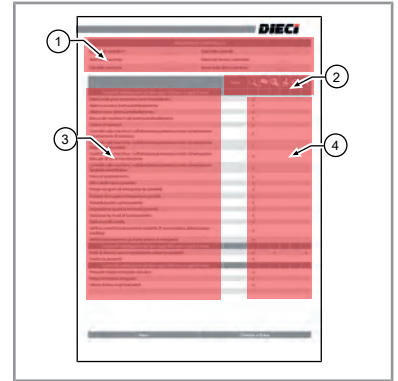

Each log (fig. 150606-1) requires the compilation of several parts:

1. Log data
2. Operations to carry out
3. Component or device on which to carry out the operation to be performed
4. Space that indicates the obligatory operation marked by the symbol "o", and the possibility to annotate an extraordinary operation not included in the log.



150606-1

23.2.4 Logs legend

Symbol	Description
	Control - Check
	Refueling
	Adjustment
	Cleaning
	Replacement
	Lubrication
	Intervention at an authorized service center

Timelines	Description
0h	According to the need - To be completed in the case of checks not linked to deadlines but more or less related to the heavy operation of the machine

Timelines	Description
10h / 1m	Every 10 hours or every month
50h / 1m	Every 50 hours or every month
250h / 2m	Every 250 hours or every 2 months
500h / 6m	Every 500 hours or every 6 months
1000h / 1y	Every 1000 hours or every year
2000h	Every 2000 hours
4000h	Every 4000 hours
2y	Every 2 years

23.3 Periodic checks and recording mode (Italian only)

- The employer/operator of the machine is required to submit the machine to the periodic checks provided by law (Ministerial Decree 12/9/59 and Legislative Decree 81/08).
- He/she also has the obligation to comply with the maintenance and surveillance plan described in this Use and Maintenance Manual of the machine.
- The periodic inspection, testing and maintenance must be carried out by specialized personnel appointed for that purpose or by a workshop authorized by the manufacturer DIECI S.r.l.
- The employer/operator of the machine must record or appoint personnel trained for the purpose to record the results of the checks into the Control Log.
- Regular checks that have to be entered in the "Control log" are:
 - Quarterly periodic checks regarding the functionality and/or efficiency of ropes/chains according to Annex VI section 3.1.2 of Legislative Decree 81/08;
 - Yearly periodic checks regarding the operation and storage of the machine for safety purposes (yearly inspections, corrosion checks, calibration check, etc.) in accordance with Annex VII of Legislative Decree 81/08;
- The law provides administrative sanctions against those who do not carry out the quarterly and yearly checks.
- The Control Log, in which it is necessary to record the checks, must be shown on request to the officials responsible for monitoring the current legislation.
- Following the yearly periodic check the Local Health Authority official (Dip.SSIA), or the private Enabled Party chosen, issues a suitability report or prescribes the necessary obligations. The user is obliged to preserve the check report together with the Control Log.
- The checks evaluation must be recorded in the following dedicated pages indicating the outcome of the check, date, signature and any comments of the party in charge.
- If the pages dedicated in this Manual are insufficient for the annotations made in the life of the machine, use additional sheets being careful to compile them in the same way.

23.4 Obligation and how to report to I.N.A.I.L. (National institute for insurance against accidents at work) (Italy only)







- The Ministerial Decree of 12/09/1959, Title II - Article 7 prescribes the obligation, to employers and users of lifting equipment with motor with capacity > 200 kg and lifting platforms for persons, to report the successful commissioning to the competent authority of the territory of the machine (currently I.N.A.I.L.), specifying the place of installation of the machine so that the authority itself may carry out the first verification.

- The report to I.N.A.I.L. must be carried out by attaching to the machine commissioning report a copy of the EC Declaration of Conformity of machinery referred to in Annex IIA of the Legislative Decree 17/2010 - Machinery Directive 2006/42/ EC.
- The original statements (CE Declaration of Conformity - Annex IIA) must be retained by the customer.
- The report to I.N.A.I.L. may be sent by registered letter with return receipt.

23.5 Control log

The following are some sheets for filling in the Control Log.

CONTROL LOG			
Control sheet no.	Control date
Machine serial number:	Controller technician name
Machine hours	Controller company name

	Controls							
250h / 2m	Longitudinal load momentum indicator check	<input type="checkbox"/>						
250h / 2m	Anti-tipping system acoustic alarm	<input type="checkbox"/>						
250h / 2m	Anti-tipping system visual alarm	<input type="checkbox"/>						
250h / 2m	Anti-tipping system movements block	<input type="checkbox"/>						
250h / 2m	Seat belts	<input type="checkbox"/>						
250h / 2m	Control over the machine \ equipment for the presence and status of conservation of Safety Stickers	<input type="checkbox"/>						
250h / 2m	Control over the machine \ equipment for the presence and conservation status of Capacity Diagrams	<input type="checkbox"/>						
250h / 2m	Control over the machine \ equipment for the presence and conservation status of the Use and maintenance manual	<input type="checkbox"/>						
250h / 2m	Control over the machine \ equipment for the presence and conservation status of Identification labels	<input type="checkbox"/>						
250h / 2m	Parking brake	<input type="checkbox"/>						
250h / 2m	Deadman seat microswitch	<input type="checkbox"/>						
250h / 2m	Emergency recovery pump (if any)	<input type="checkbox"/>						
250h / 2m	Emergency recovery button on joystick	<input type="checkbox"/>						
250h / 2m	Deadman joystick button	<input type="checkbox"/>						
250h / 2m	Reverse gear engaged acoustic signal	<input type="checkbox"/>						
250h / 2m	Three operation mode steering	<input type="checkbox"/>						
250h / 2m	Spirit level calibration	<input type="checkbox"/>						
250h / 2m	Installed equipment working mode correct operation check	<input type="checkbox"/>						
250h / 2m	Emergency stop button operation check	<input type="checkbox"/>						
400h / 3m	Chains (if any) connection points, wear and adjustment	<input type="checkbox"/>		<input type="checkbox"/>			<input type="checkbox"/>	
400h / 3m	Forks (if present)	<input type="checkbox"/>						
500h / 6m	Hydraulic system maximum pressure	<input type="checkbox"/>						
500h / 6m	Power steering calibration pressure	<input type="checkbox"/>						
500h / 6m	Jacks block valves	<input type="checkbox"/>						

Controls								
----------	--	--	--	--	--	--	--	--







Notes	Stamp and signature
-------	---------------------

CONTROL LOG			
Control sheet no.	Control date
Machine serial number:	Controller technician name
Machine hours	Controller company name

Controls								
250h / 2m	Longitudinal load momentum indicator check	<input type="checkbox"/>						
250h / 2m	Anti-tipping system acoustic alarm	<input type="checkbox"/>						
250h / 2m	Anti-tipping system visual alarm	<input type="checkbox"/>						
250h / 2m	Anti-tipping system movements block	<input type="checkbox"/>						
250h / 2m	Seat belts	<input type="checkbox"/>						
250h / 2m	Control over the machine \ equipment for the presence and status of conservation of Safety Stickers	<input type="checkbox"/>						
250h / 2m	Control over the machine \ equipment for the presence and conservation status of Capacity Diagrams	<input type="checkbox"/>						
250h / 2m	Control over the machine \ equipment for the presence and conservation status of the Use and maintenance manual	<input type="checkbox"/>						
250h / 2m	Control over the machine \ equipment for the presence and conservation status of Identification labels	<input type="checkbox"/>						
250h / 2m	Parking brake	<input type="checkbox"/>						
250h / 2m	Deadman seat microswitch	<input type="checkbox"/>						
250h / 2m	Emergency recovery pump (if any)	<input type="checkbox"/>						
250h / 2m	Emergency recovery button on joystick	<input type="checkbox"/>						
250h / 2m	Deadman joystick button	<input type="checkbox"/>						
250h / 2m	Reverse gear engaged acoustic signal	<input type="checkbox"/>						
250h / 2m	Three operation mode steering	<input type="checkbox"/>						
250h / 2m	Spirit level calibration	<input type="checkbox"/>						
250h / 2m	Installed equipment working mode correct operation check	<input type="checkbox"/>						
250h / 2m	Emergency stop button operation check	<input type="checkbox"/>						
400h / 3m	Chains (if any) connection points, wear and adjustment	<input type="checkbox"/>		<input type="checkbox"/>			<input type="checkbox"/>	
400h / 3m	Forks (if present)	<input type="checkbox"/>						
500h / 6m	Hydraulic system maximum pressure	<input type="checkbox"/>						
500h / 6m	Power steering calibration pressure	<input type="checkbox"/>						
500h / 6m	Jacks block valves	<input type="checkbox"/>						

Notes	Stamp and signature
-------	---------------------

CONTROL LOG			
Control sheet no.	Control date
Machine serial number:	Controller technician name
Machine hours	Controller company name

Controls								
250h / 2m	Longitudinal load momentum indicator check	<input type="checkbox"/>						
250h / 2m	Anti-tipping system acoustic alarm	<input type="checkbox"/>						
250h / 2m	Anti-tipping system visual alarm	<input type="checkbox"/>						
250h / 2m	Anti-tipping system movements block	<input type="checkbox"/>						
250h / 2m	Seat belts	<input type="checkbox"/>						
250h / 2m	Control over the machine \ equipment for the presence and status of conservation of Safety Stickers	<input type="checkbox"/>						
250h / 2m	Control over the machine \ equipment for the presence and conservation status of Capacity Diagrams	<input type="checkbox"/>						
250h / 2m	Control over the machine \ equipment for the presence and conservation status of the Use and maintenance manual	<input type="checkbox"/>						
250h / 2m	Control over the machine \ equipment for the presence and conservation status of Identification labels	<input type="checkbox"/>						
250h / 2m	Parking brake	<input type="checkbox"/>						
250h / 2m	Deadman seat microswitch	<input type="checkbox"/>						
250h / 2m	Emergency recovery pump (if any)	<input type="checkbox"/>						
250h / 2m	Emergency recovery button on joystick	<input type="checkbox"/>						
250h / 2m	Deadman joystick button	<input type="checkbox"/>						
250h / 2m	Reverse gear engaged acoustic signal	<input type="checkbox"/>						
250h / 2m	Three operation mode steering	<input type="checkbox"/>						
250h / 2m	Spirit level calibration	<input type="checkbox"/>						
250h / 2m	Installed equipment working mode correct operation check	<input type="checkbox"/>						
250h / 2m	Emergency stop button operation check	<input type="checkbox"/>						
400h / 3m	Chains (if any) connection points, wear and adjustment	<input type="checkbox"/>		<input type="checkbox"/>			<input type="checkbox"/>	
400h / 3m	Forks (if present)	<input type="checkbox"/>						
500h / 6m	Hydraulic system maximum pressure	<input type="checkbox"/>						
500h / 6m	Power steering calibration pressure	<input type="checkbox"/>						
500h / 6m	Jacks block valves	<input type="checkbox"/>						

Notes	Stamp and signature







CONTROL LOG			
Control sheet no.	Control date
Machine serial number:	Controller technician name
Machine hours	Controller company name

	Controls							
250h / 2m	Longitudinal load momentum indicator check	<input type="checkbox"/>						
250h / 2m	Anti-tipping system acoustic alarm	<input type="checkbox"/>						
250h / 2m	Anti-tipping system visual alarm	<input type="checkbox"/>						
250h / 2m	Anti-tipping system movements block	<input type="checkbox"/>						
250h / 2m	Seat belts	<input type="checkbox"/>						
250h / 2m	Control over the machine \ equipment for the presence and status of conservation of Safety Stickers	<input type="checkbox"/>						
250h / 2m	Control over the machine \ equipment for the presence and conservation status of Capacity Diagrams	<input type="checkbox"/>						
250h / 2m	Control over the machine \ equipment for the presence and conservation status of the Use and maintenance manual	<input type="checkbox"/>						
250h / 2m	Control over the machine \ equipment for the presence and conservation status of Identification labels	<input type="checkbox"/>						
250h / 2m	Parking brake	<input type="checkbox"/>						
250h / 2m	Deadman seat microswitch	<input type="checkbox"/>						
250h / 2m	Emergency recovery pump (if any)	<input type="checkbox"/>						
250h / 2m	Emergency recovery button on joystick	<input type="checkbox"/>						
250h / 2m	Deadman joystick button	<input type="checkbox"/>						
250h / 2m	Reverse gear engaged acoustic signal	<input type="checkbox"/>						
250h / 2m	Three operation mode steering	<input type="checkbox"/>						
250h / 2m	Spirit level calibration	<input type="checkbox"/>						
250h / 2m	Installed equipment working mode correct operation check	<input type="checkbox"/>						
250h / 2m	Emergency stop button operation check	<input type="checkbox"/>						
400h / 3m	Chains (if any) connection points, wear and adjustment	<input type="checkbox"/>		<input type="checkbox"/>			<input type="checkbox"/>	
400h / 3m	Forks (if present)	<input type="checkbox"/>						
500h / 6m	Hydraulic system maximum pressure	<input type="checkbox"/>						
500h / 6m	Power steering calibration pressure	<input type="checkbox"/>						
500h / 6m	Jacks block valves	<input type="checkbox"/>						

Notes	Stamp and signature







CONTROL LOG			
Control sheet no.	Control date
Machine serial number:	Controller technician name
Machine hours	Controller company name

	Controls							
250h / 2m	Longitudinal load momentum indicator check	<input type="checkbox"/>						
250h / 2m	Anti-tipping system acoustic alarm	<input type="checkbox"/>						
250h / 2m	Anti-tipping system visual alarm	<input type="checkbox"/>						
250h / 2m	Anti-tipping system movements block	<input type="checkbox"/>						

Controls								
250h / 2m	Seat belts	<input type="checkbox"/>						
250h / 2m	Control over the machine \ equipment for the presence and status of conservation of Safety Stickers	<input type="checkbox"/>						
250h / 2m	Control over the machine \ equipment for the presence and conservation status of Capacity Diagrams	<input type="checkbox"/>						
250h / 2m	Control over the machine \ equipment for the presence and conservation status of the Use and maintenance manual	<input type="checkbox"/>						
250h / 2m	Control over the machine \ equipment for the presence and conservation status of Identification labels	<input type="checkbox"/>						
250h / 2m	Parking brake	<input type="checkbox"/>						
250h / 2m	Deadman seat microswitch	<input type="checkbox"/>						
250h / 2m	Emergency recovery pump (if any)	<input type="checkbox"/>						
250h / 2m	Emergency recovery button on joystick	<input type="checkbox"/>						
250h / 2m	Deadman joystick button	<input type="checkbox"/>						
250h / 2m	Reverse gear engaged acoustic signal	<input type="checkbox"/>						
250h / 2m	Three operation mode steering	<input type="checkbox"/>						
250h / 2m	Spirit level calibration	<input type="checkbox"/>						
250h / 2m	Installed equipment working mode correct operation check	<input type="checkbox"/>						
250h / 2m	Emergency stop button operation check	<input type="checkbox"/>						
400h / 3m	Chains (if any) connection points, wear and adjustment	<input type="checkbox"/>		<input type="checkbox"/>			<input type="checkbox"/>	
400h / 3m	Forks (if present)	<input type="checkbox"/>						
500h / 6m	Hydraulic system maximum pressure	<input type="checkbox"/>						
500h / 6m	Power steering calibration pressure	<input type="checkbox"/>						
500h / 6m	Jacks block valves	<input type="checkbox"/>						

Notes	Stamp and signature

CONTROL LOG			
Control sheet no.	Control date
Machine serial number:	Controller technician name
Machine hours	Controller company name







Controls								
250h / 2m	Longitudinal load momentum indicator check	<input type="checkbox"/>						
250h / 2m	Anti-tipping system acoustic alarm	<input type="checkbox"/>						
250h / 2m	Anti-tipping system visual alarm	<input type="checkbox"/>						
250h / 2m	Anti-tipping system movements block	<input type="checkbox"/>						
250h / 2m	Seat belts	<input type="checkbox"/>						
250h / 2m	Control over the machine \ equipment for the presence and status of conservation of Safety Stickers	<input type="checkbox"/>						

	Controls							
250h / 2m	Control over the machine \ equipment for the presence and conservation status of Capacity Diagrams	<input type="checkbox"/>						
250h / 2m	Control over the machine \ equipment for the presence and conservation status of the Use and maintenance manual	<input type="checkbox"/>						
250h / 2m	Control over the machine \ equipment for the presence and conservation status of Identification labels	<input type="checkbox"/>						
250h / 2m	Parking brake	<input type="checkbox"/>						
250h / 2m	Deadman seat microswitch	<input type="checkbox"/>						
250h / 2m	Emergency recovery pump (if any)	<input type="checkbox"/>						
250h / 2m	Emergency recovery button on joystick	<input type="checkbox"/>						
250h / 2m	Deadman joystick button	<input type="checkbox"/>						
250h / 2m	Reverse gear engaged acoustic signal	<input type="checkbox"/>						
250h / 2m	Three operation mode steering	<input type="checkbox"/>						
250h / 2m	Spirit level calibration	<input type="checkbox"/>						
250h / 2m	Installed equipment working mode correct operation check	<input type="checkbox"/>						
250h / 2m	Emergency stop button operation check	<input type="checkbox"/>						
400h / 3m	Chains (if any) connection points, wear and adjustment	<input type="checkbox"/>		<input type="checkbox"/>			<input type="checkbox"/>	
400h / 3m	Forks (if present)	<input type="checkbox"/>						
500h / 6m	Hydraulic system maximum pressure	<input type="checkbox"/>						
500h / 6m	Power steering calibration pressure	<input type="checkbox"/>						
500h / 6m	Jacks block valves	<input type="checkbox"/>						

Notes	Stamp and signature







CONTROL LOG			
Control sheet no.	Control date
Machine serial number:	Controller technician name
Machine hours	Controller company name

	Controls							
250h / 2m	Longitudinal load momentum indicator check	<input type="checkbox"/>						
250h / 2m	Anti-tipping system acoustic alarm	<input type="checkbox"/>						
250h / 2m	Anti-tipping system visual alarm	<input type="checkbox"/>						
250h / 2m	Anti-tipping system movements block	<input type="checkbox"/>						
250h / 2m	Seat belts	<input type="checkbox"/>						
250h / 2m	Control over the machine \ equipment for the presence and status of conservation of Safety Stickers	<input type="checkbox"/>						
250h / 2m	Control over the machine \ equipment for the presence and conservation status of Capacity Diagrams	<input type="checkbox"/>						
250h / 2m	Control over the machine \ equipment for the presence and conservation status of the Use and maintenance manual	<input type="checkbox"/>						

Controls								
250h / 2m	Control over the machine \ equipment for the presence and conservation status of Identification labels	<input type="checkbox"/>						
250h / 2m	Parking brake	<input type="checkbox"/>						
250h / 2m	Deadman seat microswitch	<input type="checkbox"/>						
250h / 2m	Emergency recovery pump (if any)	<input type="checkbox"/>						
250h / 2m	Emergency recovery button on joystick	<input type="checkbox"/>						
250h / 2m	Deadman joystick button	<input type="checkbox"/>						
250h / 2m	Reverse gear engaged acoustic signal	<input type="checkbox"/>						
250h / 2m	Three operation mode steering	<input type="checkbox"/>						
250h / 2m	Spirit level calibration	<input type="checkbox"/>						
250h / 2m	Installed equipment working mode correct operation check	<input type="checkbox"/>						
250h / 2m	Emergency stop button operation check	<input type="checkbox"/>						
400h / 3m	Chains (if any) connection points, wear and adjustment	<input type="checkbox"/>		<input type="checkbox"/>			<input type="checkbox"/>	
400h / 3m	Forks (if present)	<input type="checkbox"/>						
500h / 6m	Hydraulic system maximum pressure	<input type="checkbox"/>						
500h / 6m	Power steering calibration pressure	<input type="checkbox"/>						
500h / 6m	Jacks block valves	<input type="checkbox"/>						

Notes	Stamp and signature

CONTROL LOG			
Control sheet no.	Control date
Machine serial number:	Controller technician name
Machine hours	Controller company name







Controls								
250h / 2m	Longitudinal load momentum indicator check	<input type="checkbox"/>						
250h / 2m	Anti-tipping system acoustic alarm	<input type="checkbox"/>						
250h / 2m	Anti-tipping system visual alarm	<input type="checkbox"/>						
250h / 2m	Anti-tipping system movements block	<input type="checkbox"/>						
250h / 2m	Seat belts	<input type="checkbox"/>						
250h / 2m	Control over the machine \ equipment for the presence and status of conservation of Safety Stickers	<input type="checkbox"/>						
250h / 2m	Control over the machine \ equipment for the presence and conservation status of Capacity Diagrams	<input type="checkbox"/>						
250h / 2m	Control over the machine \ equipment for the presence and conservation status of the Use and maintenance manual	<input type="checkbox"/>						
250h / 2m	Control over the machine \ equipment for the presence and conservation status of Identification labels	<input type="checkbox"/>						
250h / 2m	Parking brake	<input type="checkbox"/>						
250h / 2m	Deadman seat microswitch	<input type="checkbox"/>						

Controls								
250h / 2m	Emergency recovery pump (if any)	<input type="checkbox"/>						
250h / 2m	Emergency recovery button on joystick	<input type="checkbox"/>						
250h / 2m	Deadman joystick button	<input type="checkbox"/>						
250h / 2m	Reverse gear engaged acoustic signal	<input type="checkbox"/>						
250h / 2m	Three operation mode steering	<input type="checkbox"/>						
250h / 2m	Spirit level calibration	<input type="checkbox"/>						
250h / 2m	Installed equipment working mode correct operation check	<input type="checkbox"/>						
250h / 2m	Emergency stop button operation check	<input type="checkbox"/>						
400h / 3m	Chains (if any) connection points, wear and adjustment	<input type="checkbox"/>		<input type="checkbox"/>			<input type="checkbox"/>	
400h / 3m	Forks (if present)	<input type="checkbox"/>						
500h / 6m	Hydraulic system maximum pressure	<input type="checkbox"/>						
500h / 6m	Power steering calibration pressure	<input type="checkbox"/>						
500h / 6m	Jacks block valves	<input type="checkbox"/>						

Notes	Stamp and signature







CONTROL LOG			
Control sheet no.	Control date
Machine serial number:	Controller technician name
Machine hours	Controller company name

Controls								
250h / 2m	Longitudinal load momentum indicator check	<input type="checkbox"/>						
250h / 2m	Anti-tipping system acoustic alarm	<input type="checkbox"/>						
250h / 2m	Anti-tipping system visual alarm	<input type="checkbox"/>						
250h / 2m	Anti-tipping system movements block	<input type="checkbox"/>						
250h / 2m	Seat belts	<input type="checkbox"/>						
250h / 2m	Control over the machine \ equipment for the presence and status of conservation of Safety Stickers	<input type="checkbox"/>						
250h / 2m	Control over the machine \ equipment for the presence and conservation status of Capacity Diagrams	<input type="checkbox"/>						
250h / 2m	Control over the machine \ equipment for the presence and conservation status of the Use and maintenance manual	<input type="checkbox"/>						
250h / 2m	Control over the machine \ equipment for the presence and conservation status of Identification labels	<input type="checkbox"/>						
250h / 2m	Parking brake	<input type="checkbox"/>						
250h / 2m	Deadman seat microswitch	<input type="checkbox"/>						
250h / 2m	Emergency recovery pump (if any)	<input type="checkbox"/>						
250h / 2m	Emergency recovery button on joystick	<input type="checkbox"/>						
250h / 2m	Deadman joystick button	<input type="checkbox"/>						
250h / 2m	Reverse gear engaged acoustic signal	<input type="checkbox"/>						

Controls								
250h / 2m	Three operation mode steering	<input type="checkbox"/>						
250h / 2m	Spirit level calibration	<input type="checkbox"/>						
250h / 2m	Installed equipment working mode correct operation check	<input type="checkbox"/>						
250h / 2m	Emergency stop button operation check	<input type="checkbox"/>						
400h / 3m	Chains (if any) connection points, wear and adjustment	<input type="checkbox"/>		<input type="checkbox"/>			<input type="checkbox"/>	
400h / 3m	Forks (if present)	<input type="checkbox"/>						
500h / 6m	Hydraulic system maximum pressure	<input type="checkbox"/>						
500h / 6m	Power steering calibration pressure	<input type="checkbox"/>						
500h / 6m	Jacks block valves	<input type="checkbox"/>						

Notes	Stamp and signature

CONTROL LOG			
Control sheet no.	Control date
Machine serial number:	Controller technician name
Machine hours	Controller company name

Controls								
250h / 2m	Longitudinal load momentum indicator check	<input type="checkbox"/>						
250h / 2m	Anti-tipping system acoustic alarm	<input type="checkbox"/>						
250h / 2m	Anti-tipping system visual alarm	<input type="checkbox"/>						
250h / 2m	Anti-tipping system movements block	<input type="checkbox"/>						
250h / 2m	Seat belts	<input type="checkbox"/>						
250h / 2m	Control over the machine \ equipment for the presence and status of conservation of Safety Stickers	<input type="checkbox"/>						
250h / 2m	Control over the machine \ equipment for the presence and conservation status of Capacity Diagrams	<input type="checkbox"/>						
250h / 2m	Control over the machine \ equipment for the presence and conservation status of the Use and maintenance manual	<input type="checkbox"/>						
250h / 2m	Control over the machine \ equipment for the presence and conservation status of Identification labels	<input type="checkbox"/>						
250h / 2m	Parking brake	<input type="checkbox"/>						
250h / 2m	Deadman seat microswitch	<input type="checkbox"/>						
250h / 2m	Emergency recovery pump (if any)	<input type="checkbox"/>						
250h / 2m	Emergency recovery button on joystick	<input type="checkbox"/>						
250h / 2m	Deadman joystick button	<input type="checkbox"/>						
250h / 2m	Reverse gear engaged acoustic signal	<input type="checkbox"/>						
250h / 2m	Three operation mode steering	<input type="checkbox"/>						
250h / 2m	Spirit level calibration	<input type="checkbox"/>						
250h / 2m	Installed equipment working mode correct operation check	<input type="checkbox"/>						
250h / 2m	Emergency stop button operation check	<input type="checkbox"/>						

Controls								
400h / 3m	Chains (if any) connection points, wear and adjustment	<input type="checkbox"/>		<input type="checkbox"/>			<input type="checkbox"/>	
400h / 3m	Forks (if present)	<input type="checkbox"/>						
500h / 6m	Hydraulic system maximum pressure	<input type="checkbox"/>						
500h / 6m	Power steering calibration pressure	<input type="checkbox"/>						
500h / 6m	Jacks block valves	<input type="checkbox"/>						

Notes	Stamp and signature

23.6 Maintenance log







The following are some sheets for filling in the Maintenance Log for fixed machines.

MAINTENANCE LOG			
Maintenance sheet no.	Maintenance date
Machine serial number:	Maintenance technician name
Machine hours	Maintenance company name

Maintenance								
0h	Alternator belts \ services	<input type="checkbox"/>						
0h	Air conditioning system	<input type="checkbox"/>			<input type="checkbox"/>			
0h	Filters (air, engine oil, hydraulic oil, fuel, air conditioning system, cab)	<input type="checkbox"/>						
0h	Brake			<input type="checkbox"/>				
0h	Parking brake	<input type="checkbox"/>						
0h	Electrolyte level and battery charge	<input type="checkbox"/>						
0h	Hydraulic oil level	<input type="checkbox"/>						
0h	Engine oil level	<input type="checkbox"/>						
0h	Lighting	<input type="checkbox"/>						
0h	Tires pressure	<input type="checkbox"/>						
0h	Radiators	<input type="checkbox"/>			<input type="checkbox"/>			
0h	Radiator expansion tank	<input type="checkbox"/>	<input type="checkbox"/>					
0h	Window washer tank	<input type="checkbox"/>	<input type="checkbox"/>					
0h	Anti-tipping device inspection with load	<input type="checkbox"/>						
0h	Wear check (on both the machine and equipment if installed)	<input type="checkbox"/>						
10h / 1m	Metal structural work, no cracks	<input type="checkbox"/>						
10h / 1m	Boom chains (if installed)	<input type="checkbox"/>						
10h / 1m	Safety stickers	<input type="checkbox"/>						
10h / 1m	Safety devices	<input type="checkbox"/>						







Maintenance								
10h / 1m	Coolant	o						
10h / 1m	Engine oil level	o						
50h / 1m	Drive shafts						o	
50h / 1m	Mechanical joints						o	
50h / 1m	Mechanical joints of parking brake on the axle						o	
50h / 1m	Cab ventilation filter				o			
50h / 1m	Air filter				o			
50h / 1m	Fuel filter				o			
50h / 1m	Ropes and chains (if installed)						o	
50h / 1m	Coolant	o						
50h / 1m	Brakes oil level	o						
50h / 1m	Hydraulic oil level	o						
50h / 1m	Inching oil level (only PS transmissions)	o						
50h / 1m	Engine oil level	o						
50h / 1m	Boom pads	o					o	
50h / 1m	Hydraulic system leaks	o						
50h / 1m	Tires pressure	o						
50h / 1m	Radiators				o			
50h / 1m	Wheel nuts tightening	o						
250h / 2m	Boom chains (if installed)			o				
250h / 2m	Alternator belts \ services	o		o				
250h / 2m	Seat belts	o						
250h / 2m	Bolts tightening torque			o				
250h / 2m	Hydraulic fittings tightening torque			o				
250h / 2m	Anti-tipping device	o						
250h / 2m	Electrolyte level and battery charge	o						
250h / 2m	Ropes and chains (if any) connection points, wear and adjustment	o		o			o	
250h / 2m	Rear view mirrors	o						
500h / 6m	Cab ventilation filter					o		
500h / 6m	Air filter					o		
500h / 6m	KUBOTA fuel filter					o		
500h / 6m	KUBOTA engine oil filter					o		
500h / 6m	Hydraulic oil filter(s)					o		
500h / 6m	Forks: wear	o						
500h / 6m	Electrical system	o						
500h / 6m	Differential axle oil	o						
500h / 6m	Brakes oil					o		
500h / 6m	KUBOTA engine oil					o		
500h / 6m	Epicycloidal reduction gear oil	o						
500h / 6m	PTO gearbox oil (if installed)					o		
500h / 6m	Transmission oil	o						
500h / 6m	Block valves	o						
1000h / 1y	Telescopic boom: conditions	o						**

	Maintenance							
1000h / 1y	Telescopic boom: bearings and pivot bushes	o						**
1000h / 1y	Brakes oil circuit				o			**
1000h / 1y	Brakes oil circuit: Pressure	o						**
1000h / 1y	Equipment condition	o						**
1000h / 1y	Wheels and tires conditions	o						
1000h / 1y	Brake			o				**
1000h / 1y	Engine valves clearances	o						**
1000h / 1y	Electrical system: cables condition	o						**
1000h / 1y	Electrical system: Lighting and signaling	o						**
1000h / 1y	Electrical system: Acoustic signal devices	o						**
1000h / 1y	Hydraulic system: Jacks	o						**
1000h / 1y	Hydraulic system: Tubes and hoses	o						**
1000h / 1y	Hydraulic system: Movements speed	o						**
1000h / 1y	Coolant					o		
1000h / 1y	Differential axle oil					o		
1000h / 1y	Hydraulic oil					o		
1000h / 1y	Epicycloidal reduction gear oil					o		
1000h / 1y	PTO gearbox oil (if installed)					o		
1000h / 1y	Transmission oil					o		
1000h / 1y	Boom sliding blocks: wear	o						**
1000h / 1y	Forks support plate: wear	o						**
1000h / 1y	Engine speeds	o						**
1000h / 1y	Fuel tank				o			
1000h / 1y	Cab structure	o						**
1000h / 1y	Chassis: bearings and pivot bushes	o						**
1000h / 1y	Chassis: structure	o						**
2000h	Alternator and Starter	o						**
2000h	Ropes and chains (if installed)					o		**
2000h	Hydraulic system: Capacity	o						**
2000h	Hydraulic system: Pressures	o						**
2000h	Axial shafts oscillation	o					o	**
2000h	Radiators	o			o			**
2000h	Hydraulic oil tank				o			**
4000h	Drive shafts	o					o	**
4000h	Gearboxes cardan shaft	o						**
4000h	Wheels gearboxes clearance	o						**
4000h	Steering ball joints	o						**
4000h	Wheels gearboxes pins	o					o	**
4000h	Brake discs wear	o						**
2y	Air conditioning system (if installed): Dissipater filter					o		**
2y	Air conditioning system (if installed): Coolant	o						**
2y	Air conditioning system (if installed): Pressure switches	o		o				**
2y	Air conditioning system (if installed): Condenser and evaporator coils				o			**



Maintenance								
2y	Air conditioning system (if installed): Condensate and exhaust valve tank				<input type="radio"/>			**

Notes	Stamp and signature

MAINTENANCE LOG			
Maintenance sheet no.	Maintenance date
Machine serial number:	Maintenance technician name
Machine hours	Maintenance company name

Maintenance								
0h	Alternator belts \ services	<input type="radio"/>						
0h	Air conditioning system	<input type="radio"/>			<input type="radio"/>			
0h	Filters (air, engine oil, hydraulic oil, fuel, air conditioning system, cab)	<input type="radio"/>						
0h	Brake			<input type="radio"/>				
0h	Parking brake	<input type="radio"/>						
0h	Electrolyte level and battery charge	<input type="radio"/>						
0h	Hydraulic oil level	<input type="radio"/>						
0h	Engine oil level	<input type="radio"/>						
0h	Lighting	<input type="radio"/>						
0h	Tires pressure	<input type="radio"/>						
0h	Radiators	<input type="radio"/>			<input type="radio"/>			
0h	Radiator expansion tank	<input type="radio"/>	<input type="radio"/>					
0h	Window washer tank	<input type="radio"/>	<input type="radio"/>					
0h	Anti-tipping device inspection with load	<input type="radio"/>						
0h	Wear check (on both the machine and equipment if installed)	<input type="radio"/>						
10h / 1m	Metal structural work, no cracks	<input type="radio"/>						
10h / 1m	Boom chains (if installed)	<input type="radio"/>						
10h / 1m	Safety stickers	<input type="radio"/>						
10h / 1m	Safety devices	<input type="radio"/>						
10h / 1m	Coolant	<input type="radio"/>						
10h / 1m	Engine oil level	<input type="radio"/>						
50h / 1m	Drive shafts						<input type="radio"/>	
50h / 1m	Mechanical joints						<input type="radio"/>	
50h / 1m	Mechanical joints of parking brake on the axle						<input type="radio"/>	
50h / 1m	Cab ventilation filter				<input type="radio"/>			
50h / 1m	Air filter				<input type="radio"/>			
50h / 1m	Fuel filter				<input type="radio"/>			
50h / 1m	Ropes and chains (if installed)						<input type="radio"/>	
50h / 1m	Coolant	<input type="radio"/>						

	Maintenance							
50h / 1m	Brakes oil level	o						
50h / 1m	Hydraulic oil level	o						
50h / 1m	Inching oil level (only PS transmissions)	o						
50h / 1m	Engine oil level	o						
50h / 1m	Boom pads	o					o	
50h / 1m	Hydraulic system leaks	o						
50h / 1m	Tires pressure	o						
50h / 1m	Radiators				o			
50h / 1m	Wheel nuts tightening	o						
250h / 2m	Boom chains (if installed)			o				
250h / 2m	Alternator belts \ services	o		o				
250h / 2m	Seat belts	o						
250h / 2m	Bolts tightening torque			o				
250h / 2m	Hydraulic fittings tightening torque			o				
250h / 2m	Anti-tipping device	o						
250h / 2m	Electrolyte level and battery charge	o						
250h / 2m	Ropes and chains (if any) connection points, wear and adjustment	o		o			o	
250h / 2m	Rear view mirrors	o						
500h / 6m	Cab ventilation filter					o		
500h / 6m	Air filter					o		
500h / 6m	KUBOTA fuel filter					o		
500h / 6m	KUBOTA engine oil filter					o		
500h / 6m	Hydraulic oil filter(s)					o		
500h / 6m	Forks: wear	o						
500h / 6m	Electrical system	o						
500h / 6m	Differential axle oil	o						
500h / 6m	Brakes oil					o		
500h / 6m	KUBOTA engine oil					o		
500h / 6m	Epicycloidal reduction gear oil	o						
500h / 6m	PTO gearbox oil (if installed)					o		
500h / 6m	Transmission oil	o						
500h / 6m	Block valves	o						
1000h / 1y	Telescopic boom: conditions	o						**
1000h / 1y	Telescopic boom: bearings and pivot bushes	o						**
1000h / 1y	Brakes oil circuit				o			**
1000h / 1y	Brakes oil circuit: Pressure	o						**
1000h / 1y	Equipment condition	o						**
1000h / 1y	Wheels and tires conditions	o						
1000h / 1y	Brake			o				**
1000h / 1y	Engine valves clearances	o						**
1000h / 1y	Electrical system: cables condition	o						**
1000h / 1y	Electrical system: Lighting and signaling	o						**
1000h / 1y	Electrical system: Acoustic signal devices	o						**

Maintenance								
1000h / 1y	Hydraulic system: Jacks	<input type="radio"/>						**
1000h / 1y	Hydraulic system: Tubes and hoses	<input type="radio"/>						**
1000h / 1y	Hydraulic system: Movements speed	<input type="radio"/>						**
1000h / 1y	Coolant					<input type="radio"/>		
1000h / 1y	Differential axle oil					<input type="radio"/>		
1000h / 1y	Hydraulic oil					<input type="radio"/>		
1000h / 1y	Epicycloidal reduction gear oil					<input type="radio"/>		
1000h / 1y	PTO gearbox oil (if installed)					<input type="radio"/>		
1000h / 1y	Transmission oil					<input type="radio"/>		
1000h / 1y	Boom sliding blocks: wear	<input type="radio"/>						**
1000h / 1y	Forks support plate: wear	<input type="radio"/>						**
1000h / 1y	Engine speeds	<input type="radio"/>						**
1000h / 1y	Fuel tank				<input type="radio"/>			
1000h / 1y	Cab structure	<input type="radio"/>						**
1000h / 1y	Chassis: bearings and pivot bushes	<input type="radio"/>						**
1000h / 1y	Chassis: structure	<input type="radio"/>						**
2000h	Alternator and Starter	<input type="radio"/>						**
2000h	Ropes and chains (if installed)					<input type="radio"/>		**
2000h	Hydraulic system: Capacity	<input type="radio"/>						**
2000h	Hydraulic system: Pressures	<input type="radio"/>						**
2000h	Axial shafts oscillation	<input type="radio"/>					<input type="radio"/>	**
2000h	Radiators	<input type="radio"/>			<input type="radio"/>			**
2000h	Hydraulic oil tank				<input type="radio"/>			**
4000h	Drive shafts	<input type="radio"/>					<input type="radio"/>	**
4000h	Gearboxes cardan shaft	<input type="radio"/>						**
4000h	Wheels gearboxes clearance	<input type="radio"/>						**
4000h	Steering ball joints	<input type="radio"/>						**
4000h	Wheels gearboxes pins	<input type="radio"/>					<input type="radio"/>	**
4000h	Brake discs wear	<input type="radio"/>						**
2y	Air conditioning system (if installed): Dissipater filter					<input type="radio"/>		**
2y	Air conditioning system (if installed): Coolant	<input type="radio"/>						**
2y	Air conditioning system (if installed): Pressure switches	<input type="radio"/>		<input type="radio"/>				**
2y	Air conditioning system (if installed): Condenser and evaporator coils				<input type="radio"/>			**
2y	Air conditioning system (if installed): Condensate and exhaust valve tank				<input type="radio"/>			**

Notes	Stamp and signature

MAINTENANCE LOG			
Maintenance sheet no.	Maintenance date
Machine serial number:	Maintenance technician name

MAINTENANCE LOG	
Machine hours Maintenance company name

	Maintenance							
0h	Alternator belts \ services	<input type="radio"/>						
0h	Air conditioning system	<input type="radio"/>			<input type="radio"/>			
0h	Filters (air, engine oil, hydraulic oil, fuel, air conditioning system, cab)	<input type="radio"/>						
0h	Brake			<input type="radio"/>				
0h	Parking brake	<input type="radio"/>						
0h	Electrolyte level and battery charge	<input type="radio"/>						
0h	Hydraulic oil level	<input type="radio"/>						
0h	Engine oil level	<input type="radio"/>						
0h	Lighting	<input type="radio"/>						
0h	Tires pressure	<input type="radio"/>						
0h	Radiators	<input type="radio"/>			<input type="radio"/>			
0h	Radiator expansion tank	<input type="radio"/>	<input type="radio"/>					
0h	Window washer tank	<input type="radio"/>	<input type="radio"/>					
0h	Anti-tipping device inspection with load	<input type="radio"/>						
0h	Wear check (on both the machine and equipment if installed)	<input type="radio"/>						
10h / 1m	Metal structural work, no cracks	<input type="radio"/>						
10h / 1m	Boom chains (if installed)	<input type="radio"/>						
10h / 1m	Safety stickers	<input type="radio"/>						
10h / 1m	Safety devices	<input type="radio"/>						
10h / 1m	Coolant	<input type="radio"/>						
10h / 1m	Engine oil level	<input type="radio"/>						
50h / 1m	Drive shafts						<input type="radio"/>	
50h / 1m	Mechanical joints						<input type="radio"/>	
50h / 1m	Mechanical joints of parking brake on the axle						<input type="radio"/>	
50h / 1m	Cab ventilation filter				<input type="radio"/>			
50h / 1m	Air filter				<input type="radio"/>			
50h / 1m	Fuel filter				<input type="radio"/>			
50h / 1m	Ropes and chains (if installed)						<input type="radio"/>	
50h / 1m	Coolant	<input type="radio"/>						
50h / 1m	Brakes oil level	<input type="radio"/>						
50h / 1m	Hydraulic oil level	<input type="radio"/>						
50h / 1m	Inching oil level (only PS transmissions)	<input type="radio"/>						
50h / 1m	Engine oil level	<input type="radio"/>						
50h / 1m	Boom pads	<input type="radio"/>					<input type="radio"/>	
50h / 1m	Hydraulic system leaks	<input type="radio"/>						
50h / 1m	Tires pressure	<input type="radio"/>						
50h / 1m	Radiators				<input type="radio"/>			
50h / 1m	Wheel nuts tightening	<input type="radio"/>						
250h / 2m	Boom chains (if installed)			<input type="radio"/>				







	Maintenance							
250h / 2m	Alternator belts \ services	o		o				
250h / 2m	Seat belts	o						
250h / 2m	Bolts tightening torque			o				
250h / 2m	Hydraulic fittings tightening torque			o				
250h / 2m	Anti-tipping device	o						
250h / 2m	Electrolyte level and battery charge	o						
250h / 2m	Ropes and chains (if any) connection points, wear and adjustment	o		o			o	
250h / 2m	Rear view mirrors	o						
500h / 6m	Cab ventilation filter					o		
500h / 6m	Air filter					o		
500h / 6m	KUBOTA fuel filter					o		
500h / 6m	KUBOTA engine oil filter					o		
500h / 6m	Hydraulic oil filter(s)					o		
500h / 6m	Forks: wear	o						
500h / 6m	Electrical system	o						
500h / 6m	Differential axle oil	o						
500h / 6m	Brakes oil					o		
500h / 6m	KUBOTA engine oil					o		
500h / 6m	Epicycloidal reduction gear oil	o						
500h / 6m	PTO gearbox oil (if installed)					o		
500h / 6m	Transmission oil	o						
500h / 6m	Block valves	o						
1000h / 1y	Telescopic boom: conditions	o						**
1000h / 1y	Telescopic boom: bearings and pivot bushes	o						**
1000h / 1y	Brakes oil circuit				o			**
1000h / 1y	Brakes oil circuit: Pressure	o						**
1000h / 1y	Equipment condition	o						**
1000h / 1y	Wheels and tires conditions	o						
1000h / 1y	Brake			o				**
1000h / 1y	Engine valves clearances	o						**
1000h / 1y	Electrical system: cables condition	o						**
1000h / 1y	Electrical system: Lighting and signaling	o						**
1000h / 1y	Electrical system: Acoustic signal devices	o						**
1000h / 1y	Hydraulic system: Jacks	o						**
1000h / 1y	Hydraulic system: Tubes and hoses	o						**
1000h / 1y	Hydraulic system: Movements speed	o						**
1000h / 1y	Coolant					o		
1000h / 1y	Differential axle oil					o		
1000h / 1y	Hydraulic oil					o		
1000h / 1y	Epicycloidal reduction gear oil					o		
1000h / 1y	PTO gearbox oil (if installed)					o		
1000h / 1y	Transmission oil					o		
1000h / 1y	Boom sliding blocks: wear	o						**

Maintenance								
1000h / 1y	Forks support plate: wear	o						**
1000h / 1y	Engine speeds	o						**
1000h / 1y	Fuel tank				o			
1000h / 1y	Cab structure	o						**
1000h / 1y	Chassis: bearings and pivot bushes	o						**
1000h / 1y	Chassis: structure	o						**
2000h	Alternator and Starter	o						**
2000h	Ropes and chains (if installed)					o		**
2000h	Hydraulic system: Capacity	o						**
2000h	Hydraulic system: Pressures	o						**
2000h	Axial shafts oscillation	o					o	**
2000h	Radiators	o			o			**
2000h	Hydraulic oil tank				o			**
4000h	Drive shafts	o					o	**
4000h	Gearboxes cardan shaft	o						**
4000h	Wheels gearboxes clearance	o						**
4000h	Steering ball joints	o						**
4000h	Wheels gearboxes pins	o					o	**
4000h	Brake discs wear	o						**
2y	Air conditioning system (if installed): Dissipater filter					o		**
2y	Air conditioning system (if installed): Coolant	o						**
2y	Air conditioning system (if installed): Pressure switches	o		o				**
2y	Air conditioning system (if installed): Condenser and evaporator coils				o			**
2y	Air conditioning system (if installed): Condensate and exhaust valve tank				o			**







Notes	Stamp and signature

MAINTENANCE LOG			
Maintenance sheet no.	Maintenance date
Machine serial number:	Maintenance technician name
Machine hours	Maintenance company name

Maintenance								
0h	Alternator belts \ services	o						
0h	Air conditioning system	o			o			
0h	Filters (air, engine oil, hydraulic oil, fuel, air conditioning system, cab)	o						
0h	Brake			o				
0h	Parking brake	o						
0h	Electrolyte level and battery charge	o						







Maintenance								
0h	Hydraulic oil level	o						
0h	Engine oil level	o						
0h	Lighting	o						
0h	Tires pressure	o						
0h	Radiators	o			o			
0h	Radiator expansion tank	o	o					
0h	Window washer tank	o	o					
0h	Anti-tipping device inspection with load	o						
0h	Wear check (on both the machine and equipment if installed)	o						
10h / 1m	Metal structural work, no cracks	o						
10h / 1m	Boom chains (if installed)	o						
10h / 1m	Safety stickers	o						
10h / 1m	Safety devices	o						
10h / 1m	Coolant	o						
10h / 1m	Engine oil level	o						
50h / 1m	Drive shafts						o	
50h / 1m	Mechanical joints						o	
50h / 1m	Mechanical joints of parking brake on the axle						o	
50h / 1m	Cab ventilation filter				o			
50h / 1m	Air filter				o			
50h / 1m	Fuel filter				o			
50h / 1m	Ropes and chains (if installed)						o	
50h / 1m	Coolant	o						
50h / 1m	Brakes oil level	o						
50h / 1m	Hydraulic oil level	o						
50h / 1m	Inching oil level (only PS transmissions)	o						
50h / 1m	Engine oil level	o						
50h / 1m	Boom pads	o					o	
50h / 1m	Hydraulic system leaks	o						
50h / 1m	Tires pressure	o						
50h / 1m	Radiators				o			
50h / 1m	Wheel nuts tightening	o						
250h / 2m	Boom chains (if installed)			o				
250h / 2m	Alternator belts \ services	o		o				
250h / 2m	Seat belts	o						
250h / 2m	Bolts tightening torque			o				
250h / 2m	Hydraulic fittings tightening torque			o				
250h / 2m	Anti-tipping device	o						
250h / 2m	Electrolyte level and battery charge	o						
250h / 2m	Ropes and chains (if any) connection points, wear and adjustment	o		o			o	
250h / 2m	Rear view mirrors	o						
500h / 6m	Cab ventilation filter					o		
500h / 6m	Air filter					o		

Maintenance								
500h / 6m	KUBOTA fuel filter					o		
500h / 6m	KUBOTA engine oil filter					o		
500h / 6m	Hydraulic oil filter(s)					o		
500h / 6m	Forks: wear	o						
500h / 6m	Electrical system	o						
500h / 6m	Differential axle oil	o						
500h / 6m	Brakes oil					o		
500h / 6m	KUBOTA engine oil					o		
500h / 6m	Epicycloidal reduction gear oil	o						
500h / 6m	PTO gearbox oil (if installed)					o		
500h / 6m	Transmission oil	o						
500h / 6m	Block valves	o						
1000h / 1y	Telescopic boom: conditions	o						**
1000h / 1y	Telescopic boom: bearings and pivot bushes	o						**
1000h / 1y	Brakes oil circuit				o			**
1000h / 1y	Brakes oil circuit: Pressure	o						**
1000h / 1y	Equipment condition	o						**
1000h / 1y	Wheels and tires conditions	o						
1000h / 1y	Brake			o				**
1000h / 1y	Engine valves clearances	o						**
1000h / 1y	Electrical system: cables condition	o						**
1000h / 1y	Electrical system: Lighting and signaling	o						**
1000h / 1y	Electrical system: Acoustic signal devices	o						**
1000h / 1y	Hydraulic system: Jacks	o						**
1000h / 1y	Hydraulic system: Tubes and hoses	o						**
1000h / 1y	Hydraulic system: Movements speed	o						**
1000h / 1y	Coolant					o		
1000h / 1y	Differential axle oil					o		
1000h / 1y	Hydraulic oil					o		
1000h / 1y	Epicycloidal reduction gear oil					o		
1000h / 1y	PTO gearbox oil (if installed)					o		
1000h / 1y	Transmission oil					o		
1000h / 1y	Boom sliding blocks: wear	o						**
1000h / 1y	Forks support plate: wear	o						**
1000h / 1y	Engine speeds	o						**
1000h / 1y	Fuel tank				o			
1000h / 1y	Cab structure	o						**
1000h / 1y	Chassis: bearings and pivot bushes	o						**
1000h / 1y	Chassis: structure	o						**
2000h	Alternator and Starter	o						**
2000h	Ropes and chains (if installed)					o		**
2000h	Hydraulic system: Capacity	o						**
2000h	Hydraulic system: Pressures	o						**







	Maintenance							
2000h	Axial shafts oscillation	<input type="radio"/>					<input type="radio"/>	**
2000h	Radiators	<input type="radio"/>			<input type="radio"/>			**
2000h	Hydraulic oil tank				<input type="radio"/>			**
4000h	Drive shafts	<input type="radio"/>					<input type="radio"/>	**
4000h	Gearboxes cardan shaft	<input type="radio"/>						**
4000h	Wheels gearboxes clearance	<input type="radio"/>						**
4000h	Steering ball joints	<input type="radio"/>						**
4000h	Wheels gearboxes pins	<input type="radio"/>					<input type="radio"/>	**
4000h	Brake discs wear	<input type="radio"/>						**
2y	Air conditioning system (if installed): Dissipater filter					<input type="radio"/>		**
2y	Air conditioning system (if installed): Coolant	<input type="radio"/>						**
2y	Air conditioning system (if installed): Pressure switches	<input type="radio"/>		<input type="radio"/>				**
2y	Air conditioning system (if installed): Condenser and evaporator coils				<input type="radio"/>			**
2y	Air conditioning system (if installed): Condensate and exhaust valve tank				<input type="radio"/>			**

Notes	Stamp and signature

MAINTENANCE LOG			
Maintenance sheet no.	Maintenance date
Machine serial number:	Maintenance technician name
Machine hours	Maintenance company name

	Maintenance							
0h	Alternator belts \ services	<input type="radio"/>						
0h	Air conditioning system	<input type="radio"/>			<input type="radio"/>			
0h	Filters (air, engine oil, hydraulic oil, fuel, air conditioning system, cab)	<input type="radio"/>						
0h	Brake			<input type="radio"/>				
0h	Parking brake	<input type="radio"/>						
0h	Electrolyte level and battery charge	<input type="radio"/>						
0h	Hydraulic oil level	<input type="radio"/>						
0h	Engine oil level	<input type="radio"/>						
0h	Lighting	<input type="radio"/>						
0h	Tires pressure	<input type="radio"/>						
0h	Radiators	<input type="radio"/>			<input type="radio"/>			
0h	Radiator expansion tank	<input type="radio"/>	<input type="radio"/>					
0h	Window washer tank	<input type="radio"/>	<input type="radio"/>					
0h	Anti-tipping device inspection with load	<input type="radio"/>						
0h	Wear check (on both the machine and equipment if installed)	<input type="radio"/>						
10h / 1m	Metal structural work, no cracks	<input type="radio"/>						

	Maintenance							
10h / 1m	Boom chains (if installed)	o						
10h / 1m	Safety stickers	o						
10h / 1m	Safety devices	o						
10h / 1m	Coolant	o						
10h / 1m	Engine oil level	o						
50h / 1m	Drive shafts						o	
50h / 1m	Mechanical joints						o	
50h / 1m	Mechanical joints of parking brake on the axle						o	
50h / 1m	Cab ventilation filter				o			
50h / 1m	Air filter				o			
50h / 1m	Fuel filter				o			
50h / 1m	Ropes and chains (if installed)						o	
50h / 1m	Coolant	o						
50h / 1m	Brakes oil level	o						
50h / 1m	Hydraulic oil level	o						
50h / 1m	Inching oil level (only PS transmissions)	o						
50h / 1m	Engine oil level	o						
50h / 1m	Boom pads	o					o	
50h / 1m	Hydraulic system leaks	o						
50h / 1m	Tires pressure	o						
50h / 1m	Radiators				o			
50h / 1m	Wheel nuts tightening	o						
250h / 2m	Boom chains (if installed)			o				
250h / 2m	Alternator belts \ services	o		o				
250h / 2m	Seat belts	o						
250h / 2m	Bolts tightening torque			o				
250h / 2m	Hydraulic fittings tightening torque			o				
250h / 2m	Anti-tipping device	o						
250h / 2m	Electrolyte level and battery charge	o						
250h / 2m	Ropes and chains (if any) connection points, wear and adjustment	o		o			o	
250h / 2m	Rear view mirrors	o						
500h / 6m	Cab ventilation filter					o		
500h / 6m	Air filter					o		
500h / 6m	KUBOTA fuel filter					o		
500h / 6m	KUBOTA engine oil filter					o		
500h / 6m	Hydraulic oil filter(s)					o		
500h / 6m	Forks: wear	o						
500h / 6m	Electrical system	o						
500h / 6m	Differential axle oil	o						
500h / 6m	Brakes oil					o		
500h / 6m	KUBOTA engine oil					o		
500h / 6m	Epicycloidal reduction gear oil	o						
500h / 6m	PTO gearbox oil (if installed)					o		





	Maintenance							
500h / 6m	Transmission oil	o						
500h / 6m	Block valves	o						
1000h / 1y	Telescopic boom: conditions	o						**
1000h / 1y	Telescopic boom: bearings and pivot bushes	o						**
1000h / 1y	Brakes oil circuit				o			**
1000h / 1y	Brakes oil circuit: Pressure	o						**
1000h / 1y	Equipment condition	o						**
1000h / 1y	Wheels and tires conditions	o						
1000h / 1y	Brake			o				**
1000h / 1y	Engine valves clearances	o						**
1000h / 1y	Electrical system: cables condition	o						**
1000h / 1y	Electrical system: Lighting and signaling	o						**
1000h / 1y	Electrical system: Acoustic signal devices	o						**
1000h / 1y	Hydraulic system: Jacks	o						**
1000h / 1y	Hydraulic system: Tubes and hoses	o						**
1000h / 1y	Hydraulic system: Movements speed	o						**
1000h / 1y	Coolant					o		
1000h / 1y	Differential axle oil					o		
1000h / 1y	Hydraulic oil					o		
1000h / 1y	Epicycloidal reduction gear oil					o		
1000h / 1y	PTO gearbox oil (if installed)					o		
1000h / 1y	Transmission oil					o		
1000h / 1y	Boom sliding blocks: wear	o						**
1000h / 1y	Forks support plate: wear	o						**
1000h / 1y	Engine speeds	o						**
1000h / 1y	Fuel tank				o			
1000h / 1y	Cab structure	o						**
1000h / 1y	Chassis: bearings and pivot bushes	o						**
1000h / 1y	Chassis: structure	o						**
2000h	Alternator and Starter	o						**
2000h	Ropes and chains (if installed)					o		**
2000h	Hydraulic system: Capacity	o						**
2000h	Hydraulic system: Pressures	o						**
2000h	Axial shafts oscillation	o					o	**
2000h	Radiators	o			o			**
2000h	Hydraulic oil tank				o			**
4000h	Drive shafts	o					o	**
4000h	Gearboxes cardan shaft	o						**
4000h	Wheels gearboxes clearance	o						**
4000h	Steering ball joints	o						**
4000h	Wheels gearboxes pins	o					o	**
4000h	Brake discs wear	o						**
2y	Air conditioning system (if installed): Dissipater filter					o		**

	Maintenance							
2y	Air conditioning system (if installed): Coolant	<input type="radio"/>						**
2y	Air conditioning system (if installed): Pressure switches	<input type="radio"/>		<input type="radio"/>				**
2y	Air conditioning system (if installed): Condenser and evaporator coils				<input type="radio"/>			**
2y	Air conditioning system (if installed): Condensate and exhaust valve tank				<input type="radio"/>			**

Notes	Stamp and signature

MAINTENANCE LOG			
Maintenance sheet no.	Maintenance date
Machine serial number:	Maintenance technician name
Machine hours	Maintenance company name







	Maintenance							
0h	Alternator belts \ services	<input type="radio"/>						
0h	Air conditioning system	<input type="radio"/>			<input type="radio"/>			
0h	Filters (air, engine oil, hydraulic oil, fuel, air conditioning system, cab)	<input type="radio"/>						
0h	Brake			<input type="radio"/>				
0h	Parking brake	<input type="radio"/>						
0h	Electrolyte level and battery charge	<input type="radio"/>						
0h	Hydraulic oil level	<input type="radio"/>						
0h	Engine oil level	<input type="radio"/>						
0h	Lighting	<input type="radio"/>						
0h	Tires pressure	<input type="radio"/>						
0h	Radiators	<input type="radio"/>			<input type="radio"/>			
0h	Radiator expansion tank	<input type="radio"/>	<input type="radio"/>					
0h	Window washer tank	<input type="radio"/>	<input type="radio"/>					
0h	Anti-tipping device inspection with load	<input type="radio"/>						
0h	Wear check (on both the machine and equipment if installed)	<input type="radio"/>						
10h / 1m	Metal structural work, no cracks	<input type="radio"/>						
10h / 1m	Boom chains (if installed)	<input type="radio"/>						
10h / 1m	Safety stickers	<input type="radio"/>						
10h / 1m	Safety devices	<input type="radio"/>						
10h / 1m	Coolant	<input type="radio"/>						
10h / 1m	Engine oil level	<input type="radio"/>						
50h / 1m	Drive shafts						<input type="radio"/>	
50h / 1m	Mechanical joints						<input type="radio"/>	
50h / 1m	Mechanical joints of parking brake on the axle						<input type="radio"/>	
50h / 1m	Cab ventilation filter				<input type="radio"/>			
50h / 1m	Air filter				<input type="radio"/>			

Maintenance								
50h / 1m	Fuel filter				o			
50h / 1m	Ropes and chains (if installed)						o	
50h / 1m	Coolant	o						
50h / 1m	Brakes oil level	o						
50h / 1m	Hydraulic oil level	o						
50h / 1m	Inching oil level (only PS transmissions)	o						
50h / 1m	Engine oil level	o						
50h / 1m	Boom pads	o					o	
50h / 1m	Hydraulic system leaks	o						
50h / 1m	Tires pressure	o						
50h / 1m	Radiators				o			
50h / 1m	Wheel nuts tightening	o						
250h / 2m	Boom chains (if installed)			o				
250h / 2m	Alternator belts \ services	o		o				
250h / 2m	Seat belts	o						
250h / 2m	Bolts tightening torque			o				
250h / 2m	Hydraulic fittings tightening torque			o				
250h / 2m	Anti-tipping device	o						
250h / 2m	Electrolyte level and battery charge	o						
250h / 2m	Ropes and chains (if any) connection points, wear and adjustment	o		o			o	
250h / 2m	Rear view mirrors	o						
500h / 6m	Cab ventilation filter					o		
500h / 6m	Air filter					o		
500h / 6m	KUBOTA fuel filter					o		
500h / 6m	KUBOTA engine oil filter					o		
500h / 6m	Hydraulic oil filter(s)					o		
500h / 6m	Forks: wear	o						
500h / 6m	Electrical system	o						
500h / 6m	Differential axle oil	o						
500h / 6m	Brakes oil					o		
500h / 6m	KUBOTA engine oil					o		
500h / 6m	Epicycloidal reduction gear oil	o						
500h / 6m	PTO gearbox oil (if installed)					o		
500h / 6m	Transmission oil	o						
500h / 6m	Block valves	o						
1000h / 1y	Telescopic boom: conditions	o						**
1000h / 1y	Telescopic boom: bearings and pivot bushes	o						**
1000h / 1y	Brakes oil circuit				o			**
1000h / 1y	Brakes oil circuit: Pressure	o						**
1000h / 1y	Equipment condition	o						**
1000h / 1y	Wheels and tires conditions	o						
1000h / 1y	Brake			o				**
1000h / 1y	Engine valves clearances	o						**



	Maintenance							
1000h / 1y	Electrical system: cables condition	o						**
1000h / 1y	Electrical system: Lighting and signaling	o						**
1000h / 1y	Electrical system: Acoustic signal devices	o						**
1000h / 1y	Hydraulic system: Jacks	o						**
1000h / 1y	Hydraulic system: Tubes and hoses	o						**
1000h / 1y	Hydraulic system: Movements speed	o						**
1000h / 1y	Coolant					o		
1000h / 1y	Differential axle oil					o		
1000h / 1y	Hydraulic oil					o		
1000h / 1y	Epicycloidal reduction gear oil					o		
1000h / 1y	PTO gearbox oil (if installed)					o		
1000h / 1y	Transmission oil					o		
1000h / 1y	Boom sliding blocks: wear	o						**
1000h / 1y	Forks support plate: wear	o						**
1000h / 1y	Engine speeds	o						**
1000h / 1y	Fuel tank				o			
1000h / 1y	Cab structure	o						**
1000h / 1y	Chassis: bearings and pivot bushes	o						**
1000h / 1y	Chassis: structure	o						**
2000h	Alternator and Starter	o						**
2000h	Ropes and chains (if installed)					o		**
2000h	Hydraulic system: Capacity	o						**
2000h	Hydraulic system: Pressures	o						**
2000h	Axial shafts oscillation	o					o	**
2000h	Radiators	o			o			**
2000h	Hydraulic oil tank				o			**
4000h	Drive shafts	o					o	**
4000h	Gearboxes cardan shaft	o						**
4000h	Wheels gearboxes clearance	o						**
4000h	Steering ball joints	o						**
4000h	Wheels gearboxes pins	o					o	**
4000h	Brake discs wear	o						**
2y	Air conditioning system (if installed): Dissipater filter					o		**
2y	Air conditioning system (if installed): Coolant	o						**
2y	Air conditioning system (if installed): Pressure switches	o		o				**
2y	Air conditioning system (if installed): Condenser and evaporator coils				o			**
2y	Air conditioning system (if installed): Condensate and exhaust valve tank				o			**

Notes	Stamp and signature

MAINTENANCE LOG			
Maintenance sheet no.	Maintenance date
Machine serial number:	Maintenance technician name
Machine hours	Maintenance company name







	Maintenance							
0h	Alternator belts \ services	<input type="checkbox"/>						
0h	Air conditioning system	<input type="checkbox"/>			<input type="checkbox"/>			
0h	Filters (air, engine oil, hydraulic oil, fuel, air conditioning system, cab)	<input type="checkbox"/>						
0h	Brake			<input type="checkbox"/>				
0h	Parking brake	<input type="checkbox"/>						
0h	Electrolyte level and battery charge	<input type="checkbox"/>						
0h	Hydraulic oil level	<input type="checkbox"/>						
0h	Engine oil level	<input type="checkbox"/>						
0h	Lighting	<input type="checkbox"/>						
0h	Tires pressure	<input type="checkbox"/>						
0h	Radiators	<input type="checkbox"/>			<input type="checkbox"/>			
0h	Radiator expansion tank	<input type="checkbox"/>	<input type="checkbox"/>					
0h	Window washer tank	<input type="checkbox"/>	<input type="checkbox"/>					
0h	Anti-tipping device inspection with load	<input type="checkbox"/>						
0h	Wear check (on both the machine and equipment if installed)	<input type="checkbox"/>						
10h / 1m	Metal structural work, no cracks	<input type="checkbox"/>						
10h / 1m	Boom chains (if installed)	<input type="checkbox"/>						
10h / 1m	Safety stickers	<input type="checkbox"/>						
10h / 1m	Safety devices	<input type="checkbox"/>						
10h / 1m	Coolant	<input type="checkbox"/>						
10h / 1m	Engine oil level	<input type="checkbox"/>						
50h / 1m	Drive shafts						<input type="checkbox"/>	
50h / 1m	Mechanical joints						<input type="checkbox"/>	
50h / 1m	Mechanical joints of parking brake on the axle						<input type="checkbox"/>	
50h / 1m	Cab ventilation filter				<input type="checkbox"/>			
50h / 1m	Air filter				<input type="checkbox"/>			
50h / 1m	Fuel filter				<input type="checkbox"/>			
50h / 1m	Ropes and chains (if installed)						<input type="checkbox"/>	
50h / 1m	Coolant	<input type="checkbox"/>						
50h / 1m	Brakes oil level	<input type="checkbox"/>						
50h / 1m	Hydraulic oil level	<input type="checkbox"/>						
50h / 1m	Inching oil level (only PS transmissions)	<input type="checkbox"/>						
50h / 1m	Engine oil level	<input type="checkbox"/>						
50h / 1m	Boom pads	<input type="checkbox"/>					<input type="checkbox"/>	
50h / 1m	Hydraulic system leaks	<input type="checkbox"/>						
50h / 1m	Tires pressure	<input type="checkbox"/>						
50h / 1m	Radiators				<input type="checkbox"/>			

		Maintenance					
50h / 1m	Wheel nuts tightening	o					
250h / 2m	Boom chains (if installed)			o			
250h / 2m	Alternator belts \ services	o		o			
250h / 2m	Seat belts	o					
250h / 2m	Bolts tightening torque			o			
250h / 2m	Hydraulic fittings tightening torque			o			
250h / 2m	Anti-tipping device	o					
250h / 2m	Electrolyte level and battery charge	o					
250h / 2m	Ropes and chains (if any) connection points, wear and adjustment	o		o			o
250h / 2m	Rear view mirrors	o					
500h / 6m	Cab ventilation filter					o	
500h / 6m	Air filter					o	
500h / 6m	KUBOTA fuel filter					o	
500h / 6m	KUBOTA engine oil filter					o	
500h / 6m	Hydraulic oil filter(s)					o	
500h / 6m	Forks: wear	o					
500h / 6m	Electrical system	o					
500h / 6m	Differential axle oil	o					
500h / 6m	Brakes oil					o	
500h / 6m	KUBOTA engine oil					o	
500h / 6m	Epicycloidal reduction gear oil	o					
500h / 6m	PTO gearbox oil (if installed)					o	
500h / 6m	Transmission oil	o					
500h / 6m	Block valves	o					
1000h / 1y	Telescopic boom: conditions	o					**
1000h / 1y	Telescopic boom: bearings and pivot bushes	o					**
1000h / 1y	Brakes oil circuit				o		**
1000h / 1y	Brakes oil circuit: Pressure	o					**
1000h / 1y	Equipment condition	o					**
1000h / 1y	Wheels and tires conditions	o					
1000h / 1y	Brake			o			**
1000h / 1y	Engine valves clearances	o					**
1000h / 1y	Electrical system: cables condition	o					**
1000h / 1y	Electrical system: Lighting and signaling	o					**
1000h / 1y	Electrical system: Acoustic signal devices	o					**
1000h / 1y	Hydraulic system: Jacks	o					**
1000h / 1y	Hydraulic system: Tubes and hoses	o					**
1000h / 1y	Hydraulic system: Movements speed	o					**
1000h / 1y	Coolant					o	
1000h / 1y	Differential axle oil					o	
1000h / 1y	Hydraulic oil					o	
1000h / 1y	Epicycloidal reduction gear oil					o	
1000h / 1y	PTO gearbox oil (if installed)					o	

Maintenance								
1000h / 1y	Transmission oil					o		
1000h / 1y	Boom sliding blocks: wear	o						**
1000h / 1y	Forks support plate: wear	o						**
1000h / 1y	Engine speeds	o						**
1000h / 1y	Fuel tank				o			
1000h / 1y	Cab structure	o						**
1000h / 1y	Chassis: bearings and pivot bushes	o						**
1000h / 1y	Chassis: structure	o						**
2000h	Alternator and Starter	o						**
2000h	Ropes and chains (if installed)					o		**
2000h	Hydraulic system: Capacity	o						**
2000h	Hydraulic system: Pressures	o						**
2000h	Axial shafts oscillation	o					o	**
2000h	Radiators	o			o			**
2000h	Hydraulic oil tank				o			**
4000h	Drive shafts	o					o	**
4000h	Gearboxes cardan shaft	o						**
4000h	Wheels gearboxes clearance	o						**
4000h	Steering ball joints	o						**
4000h	Wheels gearboxes pins	o					o	**
4000h	Brake discs wear	o						**
2y	Air conditioning system (if installed): Dissipater filter					o		**
2y	Air conditioning system (if installed): Coolant	o						**
2y	Air conditioning system (if installed): Pressure switches	o		o				**
2y	Air conditioning system (if installed): Condenser and evaporator coils				o			**
2y	Air conditioning system (if installed): Condensate and exhaust valve tank				o			**

Notes	Stamp and signature

MAINTENANCE LOG			
Maintenance sheet no.	Maintenance date
Machine serial number:	Maintenance technician name
Machine hours	Maintenance company name

Maintenance								
0h	Alternator belts \ services	o						
0h	Air conditioning system	o			o			
0h	Filters (air, engine oil, hydraulic oil, fuel, air conditioning system, cab)	o						
0h	Brake			o				

	Maintenance							
0h	Parking brake	o						
0h	Electrolyte level and battery charge	o						
0h	Hydraulic oil level	o						
0h	Engine oil level	o						
0h	Lighting	o						
0h	Tires pressure	o						
0h	Radiators	o			o			
0h	Radiator expansion tank	o	o					
0h	Window washer tank	o	o					
0h	Anti-tipping device inspection with load	o						
0h	Wear check (on both the machine and equipment if installed)	o						
10h / 1m	Metal structural work, no cracks	o						
10h / 1m	Boom chains (if installed)	o						
10h / 1m	Safety stickers	o						
10h / 1m	Safety devices	o						
10h / 1m	Coolant	o						
10h / 1m	Engine oil level	o						
50h / 1m	Drive shafts						o	
50h / 1m	Mechanical joints						o	
50h / 1m	Mechanical joints of parking brake on the axle						o	
50h / 1m	Cab ventilation filter				o			
50h / 1m	Air filter				o			
50h / 1m	Fuel filter				o			
50h / 1m	Ropes and chains (if installed)						o	
50h / 1m	Coolant	o						
50h / 1m	Brakes oil level	o						
50h / 1m	Hydraulic oil level	o						
50h / 1m	Inching oil level (only PS transmissions)	o						
50h / 1m	Engine oil level	o						
50h / 1m	Boom pads	o					o	
50h / 1m	Hydraulic system leaks	o						
50h / 1m	Tires pressure	o						
50h / 1m	Radiators				o			
50h / 1m	Wheel nuts tightening	o						
250h / 2m	Boom chains (if installed)			o				
250h / 2m	Alternator belts \ services	o	o					
250h / 2m	Seat belts	o						
250h / 2m	Bolts tightening torque			o				
250h / 2m	Hydraulic fittings tightening torque			o				
250h / 2m	Anti-tipping device	o						
250h / 2m	Electrolyte level and battery charge	o						
250h / 2m	Ropes and chains (if any) connection points, wear and adjustment	o	o				o	
250h / 2m	Rear view mirrors	o						







Maintenance								
500h / 6m	Cab ventilation filter					o		
500h / 6m	Air filter					o		
500h / 6m	KUBOTA fuel filter					o		
500h / 6m	KUBOTA engine oil filter					o		
500h / 6m	Hydraulic oil filter(s)					o		
500h / 6m	Forks: wear	o						
500h / 6m	Electrical system	o						
500h / 6m	Differential axle oil	o						
500h / 6m	Brakes oil					o		
500h / 6m	KUBOTA engine oil					o		
500h / 6m	Epicycloidal reduction gear oil	o						
500h / 6m	PTO gearbox oil (if installed)					o		
500h / 6m	Transmission oil	o						
500h / 6m	Block valves	o						
1000h / 1y	Telescopic boom: conditions	o						**
1000h / 1y	Telescopic boom: bearings and pivot bushes	o						**
1000h / 1y	Brakes oil circuit				o			**
1000h / 1y	Brakes oil circuit: Pressure	o						**
1000h / 1y	Equipment condition	o						**
1000h / 1y	Wheels and tires conditions	o						
1000h / 1y	Brake			o				**
1000h / 1y	Engine valves clearances	o						**
1000h / 1y	Electrical system: cables condition	o						**
1000h / 1y	Electrical system: Lighting and signaling	o						**
1000h / 1y	Electrical system: Acoustic signal devices	o						**
1000h / 1y	Hydraulic system: Jacks	o						**
1000h / 1y	Hydraulic system: Tubes and hoses	o						**
1000h / 1y	Hydraulic system: Movements speed	o						**
1000h / 1y	Coolant					o		
1000h / 1y	Differential axle oil					o		
1000h / 1y	Hydraulic oil					o		
1000h / 1y	Epicycloidal reduction gear oil					o		
1000h / 1y	PTO gearbox oil (if installed)					o		
1000h / 1y	Transmission oil					o		
1000h / 1y	Boom sliding blocks: wear	o						**
1000h / 1y	Forks support plate: wear	o						**
1000h / 1y	Engine speeds	o						**
1000h / 1y	Fuel tank				o			
1000h / 1y	Cab structure	o						**
1000h / 1y	Chassis: bearings and pivot bushes	o						**
1000h / 1y	Chassis: structure	o						**
2000h	Alternator and Starter	o						**
2000h	Ropes and chains (if installed)					o		**

	Maintenance							
2000h	Hydraulic system: Capacity	<input type="radio"/>						**
2000h	Hydraulic system: Pressures	<input type="radio"/>						**
2000h	Axial shafts oscillation	<input type="radio"/>					<input type="radio"/>	**
2000h	Radiators	<input type="radio"/>			<input type="radio"/>			**
2000h	Hydraulic oil tank				<input type="radio"/>			**
4000h	Drive shafts	<input type="radio"/>					<input type="radio"/>	**
4000h	Gearboxes cardan shaft	<input type="radio"/>						**
4000h	Wheels gearboxes clearance	<input type="radio"/>						**
4000h	Steering ball joints	<input type="radio"/>						**
4000h	Wheels gearboxes pins	<input type="radio"/>					<input type="radio"/>	**
4000h	Brake discs wear	<input type="radio"/>						**
2y	Air conditioning system (if installed): Dissipater filter					<input type="radio"/>		**
2y	Air conditioning system (if installed): Coolant	<input type="radio"/>						**
2y	Air conditioning system (if installed): Pressure switches	<input type="radio"/>		<input type="radio"/>				**
2y	Air conditioning system (if installed): Condenser and evaporator coils				<input type="radio"/>			**
2y	Air conditioning system (if installed): Condensate and exhaust valve tank				<input type="radio"/>			**







Notes	Stamp and signature

MAINTENANCE LOG			
Maintenance sheet no.	Maintenance date
Machine serial number:	Maintenance technician name
Machine hours	Maintenance company name

	Maintenance							
0h	Alternator belts \ services	<input type="radio"/>						
0h	Air conditioning system	<input type="radio"/>			<input type="radio"/>			
0h	Filters (air, engine oil, hydraulic oil, fuel, air conditioning system, cab)	<input type="radio"/>						
0h	Brake			<input type="radio"/>				
0h	Parking brake	<input type="radio"/>						
0h	Electrolyte level and battery charge	<input type="radio"/>						
0h	Hydraulic oil level	<input type="radio"/>						
0h	Engine oil level	<input type="radio"/>						
0h	Lighting	<input type="radio"/>						
0h	Tires pressure	<input type="radio"/>						
0h	Radiators	<input type="radio"/>			<input type="radio"/>			
0h	Radiator expansion tank	<input type="radio"/>	<input type="radio"/>					
0h	Window washer tank	<input type="radio"/>	<input type="radio"/>					
0h	Anti-tipping device inspection with load	<input type="radio"/>						







Maintenance								
0h	Wear check (on both the machine and equipment if installed)	o						
10h / 1m	Metal structural work, no cracks	o						
10h / 1m	Boom chains (if installed)	o						
10h / 1m	Safety stickers	o						
10h / 1m	Safety devices	o						
10h / 1m	Coolant	o						
10h / 1m	Engine oil level	o						
50h / 1m	Drive shafts							o
50h / 1m	Mechanical joints							o
50h / 1m	Mechanical joints of parking brake on the axle							o
50h / 1m	Cab ventilation filter				o			
50h / 1m	Air filter				o			
50h / 1m	Fuel filter				o			
50h / 1m	Ropes and chains (if installed)							o
50h / 1m	Coolant	o						
50h / 1m	Brakes oil level	o						
50h / 1m	Hydraulic oil level	o						
50h / 1m	Inching oil level (only PS transmissions)	o						
50h / 1m	Engine oil level	o						
50h / 1m	Boom pads	o						o
50h / 1m	Hydraulic system leaks	o						
50h / 1m	Tires pressure	o						
50h / 1m	Radiators				o			
50h / 1m	Wheel nuts tightening	o						
250h / 2m	Boom chains (if installed)			o				
250h / 2m	Alternator belts \ services	o		o				
250h / 2m	Seat belts	o						
250h / 2m	Bolts tightening torque			o				
250h / 2m	Hydraulic fittings tightening torque			o				
250h / 2m	Anti-tipping device	o						
250h / 2m	Electrolyte level and battery charge	o						
250h / 2m	Ropes and chains (if any) connection points, wear and adjustment	o		o				o
250h / 2m	Rear view mirrors	o						
500h / 6m	Cab ventilation filter					o		
500h / 6m	Air filter					o		
500h / 6m	KUBOTA fuel filter					o		
500h / 6m	KUBOTA engine oil filter					o		
500h / 6m	Hydraulic oil filter(s)					o		
500h / 6m	Forks: wear	o						
500h / 6m	Electrical system	o						
500h / 6m	Differential axle oil	o						
500h / 6m	Brakes oil					o		
500h / 6m	KUBOTA engine oil					o		

	Maintenance							
500h / 6m	Epicycloidal reduction gear oil	o						
500h / 6m	PTO gearbox oil (if installed)					o		
500h / 6m	Transmission oil	o						
500h / 6m	Block valves	o						
1000h / 1y	Telescopic boom: conditions	o						**
1000h / 1y	Telescopic boom: bearings and pivot bushes	o						**
1000h / 1y	Brakes oil circuit				o			**
1000h / 1y	Brakes oil circuit: Pressure	o						**
1000h / 1y	Equipment condition	o						**
1000h / 1y	Wheels and tires conditions	o						
1000h / 1y	Brake			o				**
1000h / 1y	Engine valves clearances	o						**
1000h / 1y	Electrical system: cables condition	o						**
1000h / 1y	Electrical system: Lighting and signaling	o						**
1000h / 1y	Electrical system: Acoustic signal devices	o						**
1000h / 1y	Hydraulic system: Jacks	o						**
1000h / 1y	Hydraulic system: Tubes and hoses	o						**
1000h / 1y	Hydraulic system: Movements speed	o						**
1000h / 1y	Coolant					o		
1000h / 1y	Differential axle oil					o		
1000h / 1y	Hydraulic oil					o		
1000h / 1y	Epicycloidal reduction gear oil					o		
1000h / 1y	PTO gearbox oil (if installed)					o		
1000h / 1y	Transmission oil					o		
1000h / 1y	Boom sliding blocks: wear	o						**
1000h / 1y	Forks support plate: wear	o						**
1000h / 1y	Engine speeds	o						**
1000h / 1y	Fuel tank				o			
1000h / 1y	Cab structure	o						**
1000h / 1y	Chassis: bearings and pivot bushes	o						**
1000h / 1y	Chassis: structure	o						**
2000h	Alternator and Starter	o						**
2000h	Ropes and chains (if installed)					o		**
2000h	Hydraulic system: Capacity	o						**
2000h	Hydraulic system: Pressures	o						**
2000h	Axial shafts oscillation	o					o	**
2000h	Radiators	o			o			**
2000h	Hydraulic oil tank				o			**
4000h	Drive shafts	o					o	**
4000h	Gearboxes cardan shaft	o						**
4000h	Wheels gearboxes clearance	o						**
4000h	Steering ball joints	o						**
4000h	Wheels gearboxes pins	o					o	**

	Maintenance							
4000h	Brake discs wear	<input type="checkbox"/>						**
2y	Air conditioning system (if installed): Dissipater filter					<input type="checkbox"/>		**
2y	Air conditioning system (if installed): Coolant	<input type="checkbox"/>						**
2y	Air conditioning system (if installed): Pressure switches	<input type="checkbox"/>		<input type="checkbox"/>				**
2y	Air conditioning system (if installed): Condenser and evaporator coils				<input type="checkbox"/>			**
2y	Air conditioning system (if installed): Condensate and exhaust valve tank				<input type="checkbox"/>			**

Notes	Stamp and signature

MAINTENANCE LOG			
Maintenance sheet no.	Maintenance date
Machine serial number:	Maintenance technician name
Machine hours	Maintenance company name

	Maintenance							
0h	Alternator belts \ services	<input type="checkbox"/>						
0h	Air conditioning system	<input type="checkbox"/>			<input type="checkbox"/>			
0h	Filters (air, engine oil, hydraulic oil, fuel, air conditioning system, cab)	<input type="checkbox"/>						
0h	Brake			<input type="checkbox"/>				
0h	Parking brake	<input type="checkbox"/>						
0h	Electrolyte level and battery charge	<input type="checkbox"/>						
0h	Hydraulic oil level	<input type="checkbox"/>						
0h	Engine oil level	<input type="checkbox"/>						
0h	Lighting	<input type="checkbox"/>						
0h	Tires pressure	<input type="checkbox"/>						
0h	Radiators	<input type="checkbox"/>			<input type="checkbox"/>			
0h	Radiator expansion tank	<input type="checkbox"/>	<input type="checkbox"/>					
0h	Window washer tank	<input type="checkbox"/>	<input type="checkbox"/>					
0h	Anti-tipping device inspection with load	<input type="checkbox"/>						
0h	Wear check (on both the machine and equipment if installed)	<input type="checkbox"/>						
10h / 1m	Metal structural work, no cracks	<input type="checkbox"/>						
10h / 1m	Boom chains (if installed)	<input type="checkbox"/>						
10h / 1m	Safety stickers	<input type="checkbox"/>						
10h / 1m	Safety devices	<input type="checkbox"/>						
10h / 1m	Coolant	<input type="checkbox"/>						
10h / 1m	Engine oil level	<input type="checkbox"/>						
50h / 1m	Drive shafts						<input type="checkbox"/>	
50h / 1m	Mechanical joints						<input type="checkbox"/>	
50h / 1m	Mechanical joints of parking brake on the axle						<input type="checkbox"/>	

	Maintenance							
50h / 1m	Cab ventilation filter				o			
50h / 1m	Air filter				o			
50h / 1m	Fuel filter				o			
50h / 1m	Ropes and chains (if installed)						o	
50h / 1m	Coolant	o						
50h / 1m	Brakes oil level	o						
50h / 1m	Hydraulic oil level	o						
50h / 1m	Inching oil level (only PS transmissions)	o						
50h / 1m	Engine oil level	o						
50h / 1m	Boom pads	o					o	
50h / 1m	Hydraulic system leaks	o						
50h / 1m	Tires pressure	o						
50h / 1m	Radiators				o			
50h / 1m	Wheel nuts tightening	o						
250h / 2m	Boom chains (if installed)			o				
250h / 2m	Alternator belts \ services	o		o				
250h / 2m	Seat belts	o						
250h / 2m	Bolts tightening torque			o				
250h / 2m	Hydraulic fittings tightening torque			o				
250h / 2m	Anti-tipping device	o						
250h / 2m	Electrolyte level and battery charge	o						
250h / 2m	Ropes and chains (if any) connection points, wear and adjustment	o		o			o	
250h / 2m	Rear view mirrors	o						
500h / 6m	Cab ventilation filter					o		
500h / 6m	Air filter					o		
500h / 6m	KUBOTA fuel filter					o		
500h / 6m	KUBOTA engine oil filter					o		
500h / 6m	Hydraulic oil filter(s)					o		
500h / 6m	Forks: wear	o						
500h / 6m	Electrical system	o						
500h / 6m	Differential axle oil	o						
500h / 6m	Brakes oil					o		
500h / 6m	KUBOTA engine oil					o		
500h / 6m	Epicycloidal reduction gear oil	o						
500h / 6m	PTO gearbox oil (if installed)					o		
500h / 6m	Transmission oil	o						
500h / 6m	Block valves	o						
1000h / 1y	Telescopic boom: conditions	o						**
1000h / 1y	Telescopic boom: bearings and pivot bushes	o						**
1000h / 1y	Brakes oil circuit				o			**
1000h / 1y	Brakes oil circuit: Pressure	o						**
1000h / 1y	Equipment condition	o						**
1000h / 1y	Wheels and tires conditions	o						

Maintenance								
1000h / 1y	Brake			o				**
1000h / 1y	Engine valves clearances	o						**
1000h / 1y	Electrical system: cables condition	o						**
1000h / 1y	Electrical system: Lighting and signaling	o						**
1000h / 1y	Electrical system: Acoustic signal devices	o						**
1000h / 1y	Hydraulic system: Jacks	o						**
1000h / 1y	Hydraulic system: Tubes and hoses	o						**
1000h / 1y	Hydraulic system: Movements speed	o						**
1000h / 1y	Coolant					o		
1000h / 1y	Differential axle oil					o		
1000h / 1y	Hydraulic oil					o		
1000h / 1y	Epicycloidal reduction gear oil					o		
1000h / 1y	PTO gearbox oil (if installed)					o		
1000h / 1y	Transmission oil					o		
1000h / 1y	Boom sliding blocks: wear	o						**
1000h / 1y	Forks support plate: wear	o						**
1000h / 1y	Engine speeds	o						**
1000h / 1y	Fuel tank				o			
1000h / 1y	Cab structure	o						**
1000h / 1y	Chassis: bearings and pivot bushes	o						**
1000h / 1y	Chassis: structure	o						**
2000h	Alternator and Starter	o						**
2000h	Ropes and chains (if installed)					o		**
2000h	Hydraulic system: Capacity	o						**
2000h	Hydraulic system: Pressures	o						**
2000h	Axial shafts oscillation	o					o	**
2000h	Radiators	o			o			**
2000h	Hydraulic oil tank				o			**
4000h	Drive shafts	o					o	**
4000h	Gearboxes cardan shaft	o						**
4000h	Wheels gearboxes clearance	o						**
4000h	Steering ball joints	o						**
4000h	Wheels gearboxes pins	o					o	**
4000h	Brake discs wear	o						**
2y	Air conditioning system (if installed): Dissipater filter					o		**
2y	Air conditioning system (if installed): Coolant	o						**
2y	Air conditioning system (if installed): Pressure switches	o		o				**
2y	Air conditioning system (if installed): Condenser and evaporator coils				o			**
2y	Air conditioning system (if installed): Condensate and exhaust valve tank				o			**

Notes	Stamp and signature

Notes

A large rectangular area consisting of 20 horizontal grey bars, serving as a template for notes. The bars are arranged in a vertical column and are separated by thin white lines. The bars are intended for handwritten or typed notes.

